

Surgical Instruments Catalogue



 **AZQA**
INSTRUMENTS

Manufacturers & Exporters of Quality Surgical & Dental instruments

Dear Valued Buyers

We feel immense pleasure to present our latest catalogue in which we have featured a most comprehensive range of all types of quality Surgical & Dental instruments required for day to day use for Hospital. We will be pleased to quote you a competitive Price and Delivery time.

All instruments are manufactured according to the recognized standard patterns currently in use in Hospital throughout the world and are being produced under restrict control of experts to avoid any flaw and to refrain any complaint at any stage.

A group of very vast experienced persons in manufacturing handling our quality Control System.

Any instruments proven defective in workmanship or material will be replaced with out charges.

We express our thanks to all our customers for the confidence they have placed us in the past. We further assure them that we will continue our best efforts to gain their confidence in the future.

We are always at your service.

Chief Executive

Certificate of Registration



The Governing Board of Q.A. International Certification Limited hereby grants to:

AZQA INSTRUMENTS
Registration No: QAIIC / PK / 3713 - B

Hereafter called the Registered Company the right to be listed in the Directory of Registered Companies in respect of the services listed below. These services shall be offered by the Registered Company at or from only the address given below in accordance with the quality management system in compliance with the Requirements of ISO 13485:2016.

Address to which this Certificate refers:

Sadaye Shehar Road, SIE Sialkot 51310 Pakistan

Approved Scope to which this Certificate refers:

Manufacturers of Non-Active Surgical, Dental Instruments & Scissors.
(Please note that the above scope represents the certified activity of the named organization and as such, the organization may undertake additional activities that are not covered under this certification.)

Signed for and on behalf of the Board

CHIEF EXECUTIVE

SCHEME MANAGER

Certificate Issue Date: 13th February 2019 - Certificate Renewal Before: 14th December 2019
Date of Initial Registration: 13th December 2017 - Re-Certification Before: 14th December 2020

This Certificate of Registration is granted subject to the Regulations approved by the Board.

QA INTERNATIONAL

Q.A. International Certification Ltd.
Pasha Road
Dhokan
Lahore Pakistan
54762
Tel: +91 98102 34073
Fax: +91 98102 34089



Certificate of Registration



The Governing Board of Q.A. International Certification Limited hereby grants to:

AZQA INSTRUMENTS
Registration No: QAIIC / PK / 3815 - A

Hereafter called the Registered Company the right to be listed in the Directory of Registered Companies in respect of the services listed below. These services shall be offered by the Registered Company at or from only the address given below in accordance with the quality management system in compliance with the Requirements of ISO 9001:2015.

Address to which this Certificate refers:

Sadaye Shehar Road, SIE Sialkot 51310 Pakistan

Approved Scope to which this Certificate refers:

Manufacturers of Surgical, Dental, Veterinary, Beauty Care Instrument & Scissors.
(Please note that the above scope represents the certified activity of the named organization and as such, the organization may undertake additional activities that are not covered under this certification.)

Signed for and on behalf of the Board

CHIEF EXECUTIVE

SCHEME MANAGER

Certificate Issue Date: 26th February 2019 - Certificate Renewal Before: 15th February 2020
Date of Initial Registration: 14th February 2019 - Re-Certification Before: 15th February 2022

This Certificate of Registration is granted subject to the Regulations approved by the Board.

QA INTERNATIONAL

Q.A. International Certification Ltd.
Pasha Road
Dhokan
Lahore Pakistan
54762
Tel: +91 98102 34073
Fax: +91 98102 34089



DEPARTMENT OF HEALTH & HUMAN SERVICES

Public Health Service

APR 16 2019

Mr. Muhammad Rizq
Chief Executive
AZQA INSTRUMENTS
Sadaye Shehar Road,
SIE Sialkot
51310 Pakistan

and

Mr. Mohamad Ashraf
Quality Management Consultant
Near Makki Masjid
Masir Road
Sialkot, Pakistan

Dear Messrs. Rizq and Ashraf:

This is to acknowledge receipt of a March 1, 2001, letter from Mr. Mohamad Ashraf certifying the compliance of AZQA INSTRUMENTS Industries (AZQA) with the Food and Drug Administration (FDA) Quality System Regulation of 1997, which includes the current good manufacturing practice (CGMP) requirements. The Quality System Regulation is set forth in Title 21, Code of Federal Regulations (CFR), Part 820. The consultant certification confirmed that a quality system audit of Meajmy was performed February 29, 2001.

The quality system audit report states that manufactures reusable surgical instruments. Based on our review of the audit results and certification, (AZQA) has been placed on Attachment A of Import Alert #76-01. You may begin exporting devices to the United States (U.S.) that were manufactured after the consultant certified your firm's compliance with the CGMP's; however, your shipments may be subject to the guidance outlined in Attachment A of Import Alert #76-01. After five consecutive shipments comply with the import alert guidance, you may request your firm be placed on Attachment B. Submit your request directly to the FDA District office for their concurrence and further submission to this office for action.

The placement of the firm on Attachment A is limited to devices manufactured under the name of - AZQA INSTRUMENTS Sadaye Shehar Road, SIE Sialkot 51310 Pakistan. In the event the manufacturing name and/or address change, FDA requests that notification be immediately forwarded to this office. A change in the name and/or address of the manufacturing facility without notifying FDA will result in a re-evaluation of the compliance status of your firm.

Page 2 - Messrs. Rizq and Ashraf

The FDA is assured by both the consultant and (AZQA) that no devices will be imported into the U.S. that are not specifically manufactured by AZQA. This includes other manufacturers in Pakistan completing specific manufacturing processes for AZQA, and other manufacturers in Pakistan providing their devices to AZQA, for importation into the U.S.

The decision based on your consultant certification will remain in effect until such time as FDA is able to visit Sialkot, Pakistan for an inspection of your facility. During this inspection all corrections and procedures will be evaluated and confirmed. Any new CGMP deviations, or any uncorrected deviations that were previously certified to, may result in a re-evaluation of the compliance status of your firm, AZQA, including the possibility of removal from Attachment A.

We request that a quality system follow up audit be performed at AZQA, within six months of exporting devices to the U.S. He will be advised of the timing of FDA's inspection schedule.

AZQA, has an ongoing responsibility to conduct internal self-audits to assure you continue to maintain conformance with the Quality System Regulation.

If you have any questions regarding this correspondence, or need further assistance, please contact me at (301) 594-4595 or FAX (301) 594-4636.

Sincerely yours,

Carol J. Shirk
Consumer Safety Officer
General Surgery Devices Branch
Division of Enforcement I
Office of Compliance
Center for Devices and
Radiological Health



Medicines and Healthcare products Regulatory Agency

Medicines and Healthcare products Regulatory Agency
Medsafe Tower
17th Floor, One London Square
General enquiries
Telephone: 020 7044 2100 Fax: 020 7044 2101
E-mail: mhra@mhra.gov.uk

Mr D Iqbal
Blue Star Company
48, Therothoff Road
Newstead Green
Southall
Middlesex
UB8 3RQ

Website: www.mhra.gov.uk
Headline: 0207 044 0100
Headline Fax: 0207 044 1102

Date of: 04/10/2019

09 October 2019

Dear Mr. D Iqbal,

MEDICAL DEVICES REGULATION 2002; REGULATION 19
Registration of Persons Placing Medical Devices on the Market

This year for informing the Competent Authority of the details of Manufacturers located in Manufacturers Address:-
Name:-
for whom you are acting as the authorized representative and for supplying the medical device information.

Your registration has been recorded based on your declaration that you have determined that the devices fall within the definition of "medical device", and that you have classified it/ them as falling within Regulation 19 taking into account the intended purpose(s) and mode(s) of action. In accepting your registration, I should make clear that the Competent Authority does not examine each individual notification and therefore cannot and does not necessarily endorse those determinations. Neither does this letter represent any form of accreditation or approval by the UK Competent Authority.

Your registration is based upon your declaration on the RCG form and means that:

For Manufacturers of Class I medical devices, Assemblers, and Distributors: You should now be operating under the Medical Device Directive and the above Regulations for the products you asked us to register, by fully complying with the essential requirements, CE marking those products or labelling them as such.

For Manufacturers of Custom-made devices: You should be ready to claim compliance with the Directive and Regulations and should be manufacturing custom-made devices in accordance with their requirements.

If you stop placing devices on the market or if you are not complying with the Regulations you should inform us so that we can amend our records. You should be aware that it is an offence to place on the market CE marked devices that do not comply with the regulations.



An Alternative Agency of the Department of Health

The information you provided has been recorded against the reference number shown at the top of this letter, which we ask you to quote in all future correspondence and communications.

Please inform us of any changes to:

- The company information
- Additional generic group of devices (any individual products within an existing generic group)
- Discontinuation of a generic group of devices.

Please use RCG, the Registration form, to tell us about any of these changes.

Thank you for registering the following generic groups of devices:

Class I Devices:
Dental Instruments (Re-Usable & Non-Powered)
Surgical Instruments (Re-Usable And Non-Powered)

Custom Made Devices:
None

Products Covered By Article 12:
None

Should you have any queries regarding your registration please contact us on the telephone number given at the top of this letter.

Yours sincerely

Rob Higgins



CA014167



ACCREDITED COMPANY
BS EN ISO 9001:2009
BS EN ISO 13485:2003
QAIIC/PK/3587-A
QAIIC/PK/3589-B



300957719



GMP Approved Facility



A-20939



S286



1256696-9

All third party names/logos/trademarks are the property of their respected owners.

01 DIAGNOSTIC INSTRUMENTS	01 To 13
02 TROCARS, SUCTION TUBES & CANNULAS	14 To 23
03 SCALPEL HANDLE, SCALPEL BLADES, DISSECTING KNIVES & SAWS	24 To 32
04 GENERAL OPERATING SCISSORS	33 To 60
05 DRESSING & TISSUE FORCEPS	61 To 78
06 HAEMOSTATIC FORCEPS	79 To 100
07 NEEDLE HOLDERS	101 To 126
08 RETRACTORS	127 To 161
09 Plastic SURGERY INSTRUMENTS	162 To 177
10 BONE SURGERY INSTRUMENTS	182 To 234

11 NEUROSURGERY INSTRUMENTS	235 To 262
12 CARDIOVASCULAR & THORACIC INSTRUMENTS	263 To 284
13 OPHTHALMIC INSTRUMENTS	285 To 294
14 ENT SURGERY	295 To 337
15 INTESTINAL AND RECTAL INSTRUMENTS	338 To 354
16 UROLOGY INSTRUMENTS	355 To 368
17 GYNECOLOGY / OBSTETRICS INSTRUMENTS	369 To 408
18 LIPOSUCTION CANNULAS	409 To 421
19 HOLLOW WARES	422 To 431

DIAGNOSTIC INSTRUMENTS





Duplex Stethoscope 01-001
super lightweight



Duplex-Baby Stethoscope 01-002
super lightweight



Anaestophon Stethoscope 01-003
Super Lightweight



Clar Mead Mirror komplett 6 Volt 01-004



01-007
Ø 50mm



Pinard Wooden Stethoscope 01-008
18 cm



Pinard Aluminium Stethoscope 01-009
15 cm



Weber Aesthesiometer 01-010
9 cm



Ziegler 01-005
Ø 90mm with head band without protection cap



Ziegler 01-006
Ø 90mm with head band with protection cap

I N S T R U M E N T S



01-011
16cm
01-012
20cm
01-013
25cm

Magill Catheter Intubating Forceps



Magill Catheter Intubating Forcep Gold 01-014
6.5" (2.5" shaft) , Infant , hole (dia 2.00 mm)
01-015
7.5" (3" shaft) , Infant , hole (dia 2.30 mm)
01-016
7.5" (4" shaft) , Infant , hole (dia 2.60 mm)



Magill Catheter Intubating Forcep GOLD 01-017
8" (4" shaft) , Child , hole (dia 3.00 mm)
01-018
8" (4" shaft) , Child , oval tip (5.38 mm X 4.15 mm)
01-019
9" (5" shaft) , Adult , oval (6.80 mm x 5.00 mm)
01-020
10" (5" shaft) , Adult , oval (9.60 mm x 7.70 mm)



Neuro-Duoflex Hammer
01-021 22cm



Dejerine Hammer
01-022 20cm



Dejerine Hammer
01-023 20cm



Troemner Hammer
01-024 145 g
01-025 175 g
01-026 235 g
24.5 cm
spare rubber



Troemner-Simplex Hammer
01-027 21cm



Buck Hammer
01-028 18.5cm



Buck Hammer
01-029 18cm



Taylor Hammer
01-030 18cm
01-031 20cm



Taylor Hammer
01-032 18cm



Babinsky Hammer
01-033 22 cm



Babinsky Hammer
01-034 22 cm



Rabiner Hammer
01-035 25.5 cm
with needle & brush



Berliner Hammer
01-036 20 cm



Traube Hammer
01-037 16 cm



Wartenberg Pinwheel
01-038 19 cm

I N S T R U M E N T S

MC-INTOSH FIBER OPTIC LARYNGOSCOPE BLADE

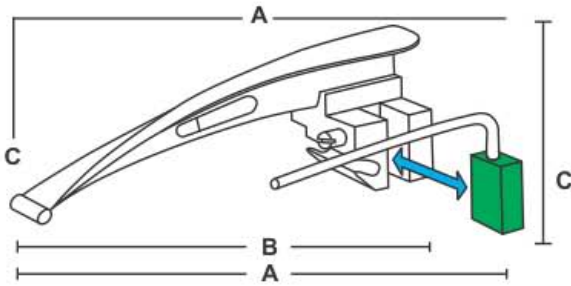

BLADE

Size	A	B	C	Working Length
0	77mm	53mm	14mm	55mm
1	95mm	72mm	43mm	70mm
2	111mm	86mm	44mm	78mm
3	133mm	109mm	44mm	108mm
4	151mm	129mm	44mm	133mm

Mc-Intosh Laryngoscope Fiber Optic

Halogen illumination. Manufactured from AISI 304 Stainless-Steel. Halogen Illumination 2.5 V. The Bulb is inside the handle in order to simplify the sterilization of the blades. All blades and handles are interchangeable with other leading manufacturer. All sets can be combined as per your request, and delivered in Green plastic case.

Blades Availability:

- ★ Matt Finish
- ★ Mirror Finish
- ★ Sand Blast Finish
- ★ Pls, confirm in your order list

MC-INTOSH LARYNGOSCOPE

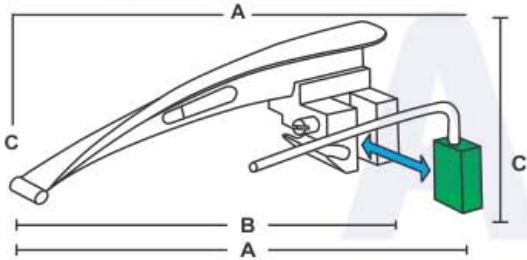

BLADE

Size	A	B	C	Working Length
0	77mm	53mm	14mm	55mm
1	95mm	72mm	43mm	70mm
2	111mm	86mm	44mm	78mm
3	133mm	109mm	44mm	108mm
4	151mm	129mm	44mm	133mm

Fiber Optic Laryngoscope

Plastic case, Halogen illumination. Manufactured from AISI 304 Stainless Steel Halogen Illumination 2.5 V. The Bulb is inside the handle in order to simplify the sterilization of the blades. All blades and handles are interchangeable with other leading manufacturer. All sets can be combined as per your request, and delivered in Green plastic case.

Blades Availability:

- ★ Matt Finish
- ★ Mirror Finish
- ★ Sand Blast Finish
- ★ Pls, confirm in your order list

Mc-INTOSH FIBER OPTIC LARYNGOSCOPE SET HALOGEN ILLUMINATION

01-039 PEDIATRIC SET

Set of 0,1,2 Blades
Supplied in Green plastic case

01-040 STANDARD SET

Set of 1,2,3 Blades
Supplied in Green plastic case

01-041 ADULT SET

Set of 1,2,3,4 Blades
Supplied in Green plastic case



Laryngoscope Battery
Handle for Adult
C type 2 batteries
01-047



Mc-Intosh Fiber Optic
Laryngoscope Set
Halogen Illumination
Manufactured by AISI:
304 Stainless Steel Material



Fig. 0
01-042



Fig. 1
01-043



Fig. 2
01-044



Fig. 3
01-045



Fig. 4
01-046

Mc-INTOSH FIBER OPTIC LARYNGOSCOPE SET HALOGEN ILLUMINATION

AVAILABLE SETS WITH BATTERY HANDLE

01-048 PEDIATRIC SET

Set of 0,1,2 Blades
Supplied in Green plastic case

01-049 STANDARD SET

Set of 1,2,3 Blades
Supplied in Green plastic case

01-050 ADULT SET

Set of 1,2,3,4 Blades
Supplied in Green plastic case



01-056
Laryngoscope Battery
Handle for Adult
C type 2 Batteries



Fig. 0
01-051



Fig. 1
01-052



Fig. 2
01-053



Fig. 3
01-054



Fig. 4
01-055



01-057
Laryngoscope
Bulb Small



01-058
Laryngoscope
Bulb Large

Mc-Intosh Laryngoscope Set
of Fiber Optic
Halogen Illumination
Manufactured From: AISI 304
Stainless Steel Material

FIBER OPTIC LARYNGOSCOPE MILLER

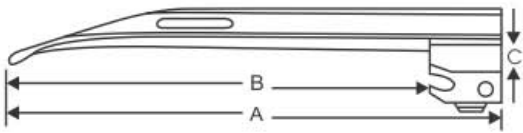

BLADE

Size	A	B	C	Working Length
0	75mm	53mm	26mm	55mm
1	111mm	80mm	26mm	80mm
2	151mm	134mm	28mm	130mm
3	188mm	167mm	28mm	170mm
4	203mm	180mm	28mm	180mm



01-067
Laryngoscope Battery Handle for Adult C type 2 Batteries

FIBER OPTIC LARYNGOSCOPE MILLER

AVAILABLE SETS WITH BATTERY HANDLE

01-059 PEDIATRIC SET
Set of 0,1,2
Blades
Supplied in Green plastic case

01-060 STANDARD SET
Set of 1,2,3
Blades
Supplied in Green plastic case

01-061 ADULT SET
Set of 1,2,3,4
Blades
Supplied in Green plastic case



MC-INTOSH LARYNGOSCOPE

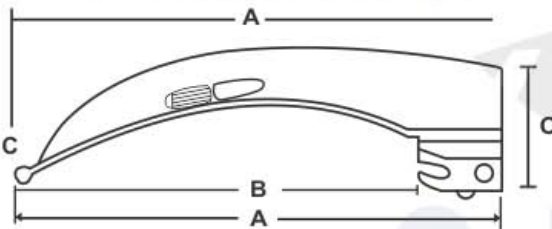

BLADE

Size	A	B	C	Working Length
0	80mm	58mm	30mm	55mm
1	97mm	76mm	36mm	70mm
2	111mm	88mm	36mm	78mm
3	133mm	112mm	36mm	108mm
4	154mm	131mm	38mm	133mm

Mc-Intosh Laryngoscope

Plastic case, Standard illumination. Manufactured from AISI 304 Stainless Steel Matt Type, Standard Illumination 2.5 V. All blades and handles are interchangeable with other leading manufacturer. All sets can be combined as per your request, and delivered in Gray plastic case.

Blades Availability:

- * Matt Finish
- * Mirror Finish
- * Sand Blast Finish
- * Pls, confirm in your order list



01-077
With one Spare Bulb



01-076
Laryngoscope Battery Handle for Adult C type 2 Batteries



Mc-Intosh Laryngoscope Set Standard Illumination Manufactured From Stainless Steel Material

CONVENTIONAL LARYNGOSCOPE SET

Mc-INTOSH LARYNGOSCOPE SET STANDARD ILLUMINATION

AVAILABLE SETS WITH BATTERY HANDLE

01-068 PEDIATRIC SET
Set of 0,1,2 Blades
Supplied in Gray plastic case

01-069 STANDARD SET
Set of 1,2,3 Blades
Supplied in Gray plastic case

01-070 ADULT SET
Set of 1,2,3,4 Blades
Supplied in Gray plastic case



MC-INTOSH LARYNGOSCOPE

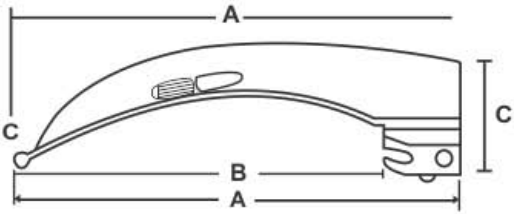

BLADE

Size	A	B	C	Working Length
0	80mm	58mm	30mm	55mm
1	97mm	76mm	36mm	70mm
2	111mm	88mm	36mm	78mm
3	133mm	112mm	36mm	108mm
4	154mm	131mm	38mm	133mm

Mc-Intosh Laryngoscope

Plastic case, Standard illumination. Manufactured from AISI 304 Stainless Steel. All blades and handles are interchangeable with other leading manufacturer. All sets can be combined as per your request, and delivered in Blue plastic case.

Blades Availability:

- * Matt Finish
- * Mirror Finish
- * Sand Blast Finish
- * Pls, confirm in your order list



01-087
With two Spare Bulbs



01-086
Laryngoscope Battery Handle for Adult C type 2 batteries



CONVENTIONAL LARYNGOSCOPE SET

Mc-INTOSH LARYNGOSCOPE CONVENTIONAL STANDARD ILLUMINATION

AVAILABLE SETS WITH BATTERY HANDLE

- 01-078 PEDIATRIC SET**
Set of 0,1,2 Blades.
Supplied in Blue plastic case
- 01-079 STANDARD SET**
Set of 1,2,3 Blades.
Supplied in Blue plastic case
- 01-080 ADULT SET**
Set of 1,2,3,4 Blades.
Supplied in Blue plastic case



Mc-Intosh Laryngoscope Conventional Standard Illumination
Manufactured From Stainless Steel material

LARYNGOSCOPE MILLER

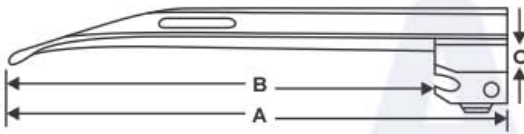

BLADE

Size	A	B	C	Working Length
0	75mm	53mm	26mm	55mm
1	111mm	80mm	26mm	80mm
2	151mm	134mm	28mm	130mm
3	188mm	167mm	28mm	170mm
4	203mm	180mm	28mm	180mm

Mc-Intosh Laryngoscope

Plastic case, Standard illumination. Manufactured from AISI 304 Stainless Steel. All blades and handles are interchangeable with other leading manufacturer. All sets can be combined as per your request, and delivered in Blue plastic case.

Blades Availability:

- * Matt Finish
- * Mirror Finish
- * Sand Blast Finish
- * Pls, confirm in your order list



01-097
With two Spare Bulbs



01-096
Laryngoscope Battery Handle for Adult C type 2 batteries

CONVENTIONAL LARYNGOSCOPE SET

LARYNGOSCOPE SET OF CONVENTIONAL MILLER STANDARD ILLUMINATION

AVAILABLE SETS WITH BATTERY HANDLE

- 01-088 PEDIATRIC SET**
Set of 0,1,2 Blades
Supplied in Blue plastic case
- 01-089 STANDARD SET**
Set of 1,2,3 Blades
Supplied in Blue plastic case
- 01-090 ADULT SET**
Set of 1,2,3,4 Blades
Supplied in Blue plastic case



Laryngoscope Set of conventional Miller Standard Illumination
Manufactured From Stainless Steel Material



Laryngoscope Flexible (Mc-Coy)



Available blade sizes 2,3 & 4 with 'AA' & 'C' type battery handles
01-100
01-101
01-102

01-098
CONVENTIONAL SET
Flexible Laryngoscope Conventional
Halogen Illumination Manufactured From Stainless Steel High grade 304 material.

01-099
'C' type handle



Available Blade sizes 2,3 & 4 with 'AA' & 'C' type battery handles
01-105
01-106
01-107

01-103 FIBER OPTIC SET
Flexible Laryngoscope Set of Fiber Optic
Halogen Illumination Manufactured From Stainless Steel High grade 304 material packed in green plastic box.



Laryngoscope Battery Handle for Adult AA Batteries
01-104



DIAGNOSTIC PENTOSCOPE SET 01-108

2.5 V Standard illumination for use with 2 batteries type AA.
Consisting:
Universal Handle thread type fit for all Pentoscope Heads like.

- Otoscope Head.
- Ophthalmoscope Head.
- Throat Branch Head.
- Mouth Mirrors Head.

It have two exploring mirrors No. 4 & 5 mm.
Its spare 06 disposable Plastic ear Canulas are with sizes 2 x 2.50 mm, 2 x 3.50 mm & 2 x 4.5 mm.
On special order it can be as 2 x 1.5 mm for new born babies 2 x 2.5 mm for pediatric and 2 x 4 mm for adults, so it means total 06 canula also available in a plastic tube packing.

Sturdy adjustment mount bracket
2 spare 2.5 V bulb.
Pentoscope set battery handle is operating with two AA size batteries.

This Pentoscope set Packed in our new beautiful Blue Colour plastic case in same blue inner packing material.
Spare parts also available of any item.



With 2 spare Bulbs

Mouth Mirrors Head



Otoscope Head



Sturdy Adjustment Mount Bracket



Standard illumination



Plastic ear Canulas

Handle

Two laryngeal mirrors: n. 4 and 5

 Bent-arm illuminator:
 pin contact fitting.

Specula

With 2 spare Bulbs

**Professional Otoscope & Ophthalmology Set
 ENT Medical Diagnostic Set**
01-109

 2.5 V Standard illumination for use with
 2 batteries C type.

Including:

Otoscope Head: Luir Lock fitting.

Chrome plated.

Fix lens 4 x in plastic mount can be

removed for introduction of instruments.

Specula sizes: 2.5, 3.5 & 4.5 mm Included,

Ophthalmoscope head: Luir Lock fitting.

Lens selection wheel permits choice of corrective

lenses from 0 to - 20 and 0 to +20 diopters.

Single large circle aperture.

Bent-arm illuminator: pin contact fitting.

Nasal speculum: Chrome plated.

Two laryngeal mirrors: n. 4 and 5.

Battery handle: 28mm. For 2 cell C-batteries.

Chrome plated. For adjustment of all illumination.

Replacement bulb: 2.5 V

 Diagnostic set is supplied in our new beautiful
 look and quality Blue Case, which protect our quality
 Products from moisturizing and damaging.

Otoscope Head

Nasal speculum: Chrome plated.

Ophthalmoscope head

ENT Specula



Two laryngeal mirrors: n. 4 and 5



Bent-arm illuminator: pin contact fitting.

**Universal Otoscope & Ophthalmology Set
ENT Medical Diagnostic Set**

01-110

2.5 V Standard illumination for use with 2 batteries type C.

Including:

Otoscope Head: Luir Lock fitting.
Chrome plated.

Fix lens 4 x in plastic mount can be removed for introduction of instruments.

Specula sizes: 2.5, 3.5 & 4.5 mm Included,

Ophthalmoscope head: pin contact fitting.

Lens selection wheel permits choice of corrective lenses from 0 to - 20 and 0 to +20 diopters.

Single large circle aperture.

Bent-arm illuminator: Luir Lock fitting.

Nasal speculum: Chrome plated.

Two laryngeal mirrors: n. 4 and 5.

Battery handle: 28mm. For 2 cell C-batteries.

Chrome plated. For adjustment of all illumination.

Replacement bulb: 2.5 V

The Diagnostic set is supplied in new beautiful look and quality Blue Case, which protect our quality Products from moisturizing and damaging.



Nasal speculum: Chrome plated.



ENT Specula



Otoscope Head



Ophthalmoscope Head



Handle



Standard Otoscope + Ophthalmoscope Set
01-111

This Set is with 2.5 V standard illumination, handle is chrome plated as well otoscope head too. Handle and head is Luir / Faster lock fitting. Head of otoscope is with 6x magnifying glass. 03 Resuable speculas with sizes 2.5, 3.5 & 4.5 mm. A Full Functional Ophthalmoscope compact durable, light weight. Standard bulb and precision system 4 different apertures selection range of lenses -20 to +20 bright white light and brilliant image A Full Functional Ophthalmoscope Battery handle for 2 'c' batteries. Rheostat for adjustment of illumination. Supply in Black Plastic Box Packing.



Otoscope Head



ENT Specula



Ophthalmoscope head



ENT Specula



'C' type Battery handle



Standard Ophthalmoscope Set
01-112

A Full Functional Ophthalmoscope compact durable, light weight. Standard bulb and precision system 4 different apertures selection range of lenses -20 to +20 bright white light and brilliant image Packed in Black Plastic Case.



Standard Otoscope Set
01-113

this otoscope is with 2.5 V standard illumination, handle is chrome plated as well otoscope head too. Handle and head is Luir / Faster lock fitting. Head of otoscope is with 6x magnifying glass. 03 Resuable speculas with sizes 2.5, 3.5 & 4.5 mm. Battery handle for 2 'c' batteries. Rheostat for adjustment of illumination. Supply in Black Pouch Packing



Ophthalmoscope head



'C' type Battery Handle



**Standard Otoscope Set
01-114**

this otoscope is with 2.5 V standard illumination, handle is chrome plated as well otoscope head too. Handle and head is Luir / Faster lock fitting. Head of otoscope is with 6x magnifying glass. 03 Reusable speculas with sizes 2.5, 3.5 & 4.5 mm. Battery handle for 2 'c' batteries. Rheostat for adjustment of illumination. Supply in Black Pouch Packing

**Otoscope + Ophthalmoscope Set
01-115**

This otoscope is with 2.5 V standard illumination, handle is chrome plated as well otoscope head too. Handle and head is Luir / Faster lock fitting. Head of otoscope is with 6x magnifying glass. 03 Reusable speculas with sizes 2.5, 3.5 & 4.5 mm. A Full Functional Ophthalmoscope compact durable, light weight. Standard bulb and precision system 4 different apertures selection range of lenses -20 to +20 bright white light and brilliant image A Full Functional Ophthalmoscope Battery handle for 2 'c' batteries. Rheostat for adjustment of illumination. Supply in Black Pouch Packing.

**Standard Ophthalmoscope
01-116**

A Full Functional Ophthalmoscope. compact durable, Standard bulb and precision system 4 different apertures selection range of lenses -20 to +20 bright white light and brilliant image Handle made of Stainless Steel Material.

**Mini Ophthalmoscope
01-117**

A Full Functional Ophthalmoscope. compact durable, light weight. Standard bulb and precision system 4 different apertures selection range of lenses -20 to +20 bright white light and brilliant image Made of plastic Material.

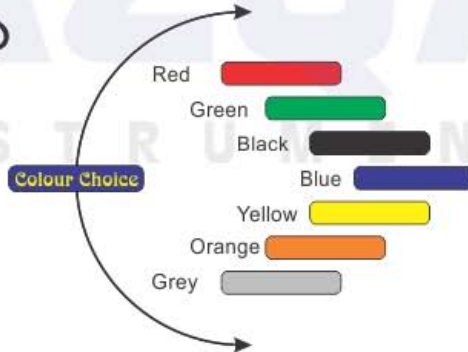

**Mini Ophthalmoscope
01-118**

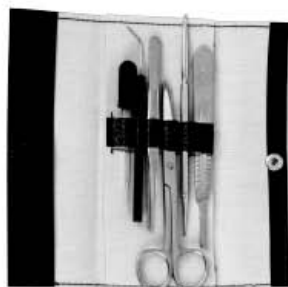
A Full Functional Ophthalmoscope. compact durable, light weight. Standard bulb and precision system 4 different apertures selection range of lenses -20 to +20 bright white light and brilliant image made of plastic Material.

01-119

Dissecting Set of 6 pcs.

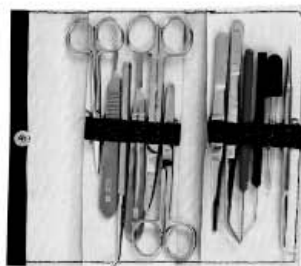
- Dropper Oil
- Probe Plastic Handle
- Dressing Forceps
- Dressing Scissors S/s
- Hook
- Scalpel Handle 4

01-120

Dissecting Set of 12 pcs.

- Iris Scissors
- Scalpel Knives 4
- Probe Single Ended
- Scalpel Handle 3
- Dressing Scissors S/s
- Dressing Scissors S/b
- Dressing Forceps
- College Tweezer
- Probe Straight Plastic Handle
- Probe Angular Plastic Handle
- Dropper Owl
- Hook

01-121
New Instructor's Dissecting set

Contain quality stainless steel Instrument Enclosed in an attractive zippered case Scissor surgical 4 1/2" scissors fine point 4 1/2" Forceps fine point Str . Forcep fine point Cvd . Mosquito forceps Cvd 5" box lock . One piece scalpel 1 1/2" blade Surgeon handle # 4 . Mall probe and seeker 2 plastic handle str needle also 2 blade # 22 for each set.

01-122
Dissecting Set- Advanced

Stainless steel, consisting of 12 instruments for accurate dissection. Supplied in zipper leather case.

Kit consists of:

- Scissors - 2 pcs. Forceps - 2 pcs. Needle - 2 pcs.
- Artery Forceps - 1 pc. Tissue Forceps - 1 pc.
- Seeker - 1 pc. Scalpel Handle w/ Blade - 1 pc.
- Bone Cutter - 1 pc. Dental Probe & Seeker - 1 pc

01-123
Dissecting Kit

Kit includes:

- 1 4 1/2" Dissecting forceps with curved and serrated tips
- 1 Curved dissecting needle 1 Glass pipette with rubber bulb
- 1 4 1/2" Dissecting forceps straight and serrated tips
- 1 Dissecting scalpel, 6" long, 1 1/2" cutting edge.
- 1 4 1/2" Dissecting scissors, sharp, straight points
- 1 Plastic ruler 6", 1/16" div., millimeter and centimeter

01-124
Dissecting Set - Pro

Stainless steel, consisting of 20 instruments for accurate dissection. Supplied in zipper leather case.

Kit consists of:

- Scissors - 2 pcs. Forceps - 2 pcs. Needles - 4 pcs. Scalpel - 1 pc.
- B.P. Handle w/ Blade - 1 pc. Razor - 1 pc. Ruler 6" - 1 pc.
- Magnifying Glass - 1 pc. Glass Slide - 1 pc. Chain and Hook - 1 pc.
- Cover Slips - 1 pc. Blow Pipe - 1 pc. Needle Wooden Handle - 1 pc.
- Dropper Glass - 1 pc. Brush - 1 pc.

I N S T R U M E N T S

01-125
Dissecting Set - Popular

Stainless steel, consisting of 14 instruments for accurate dissection. Complete in zipper leather case.

Kit consists of:

- Scissors - 2 pcs. Forceps - 2 pcs. Needles - 4 pcs. Scalpel - 1 pc.
- B.P. Handle w/ Blade - 1 pc. Razor - 1 pc. Magnifying Glass - 1 pc.
- Chain and Hook - 1 pc. Blow Pipe - 1 pc.

01-126
Dissecting Set - Senior

Stainless steel, consisting of 9 instruments for accurate dissection. Supplied in zipper leather case.

Kit consists of:

- Scissors - 2 pcs. Forceps - 2 pcs. Needle - 2 pcs. Scalpel - 1 pc.
- Scalpel Handle w/ Blade - 1 pc. Ruler 6" - 1 pc.



01-127
Dissecting Set



01-128
Dissecting Set



01-129
Dissecting Set



01-130
Dissecting Set



01-131
Dissecting Set



01-132
Dissecting Set



Jameson Caliper
01-133 8 cm



Townley Caliper
01-134 10 cm



Vernier Caliper
01-135 15 cm



Vernier Caliper
01-136 15 cm



Carroll Pocket Goniometer
01-137 14.5cm



Möeltgen Flexometer
01-138 24cm



Bertillon Measuring Device
01-139 32 cm



Castroviejo-Epker Caliper
01-140 18 cm
Measuring range 40 mm, straight



Castroviejo-Epker Caliper
01-141 18 cm Angled
Measuring range 40 mm



Castroviejo
01-142 18cm
Bone Caliper Straight



Castroviejo
01-143 18cm
Bone Caliper Curved



Castroviejo-Epker Caliper
01-144 9 cm Str.
Measuring range, 40 mm
01-145 9 cm Cvd.
Measuring range, 40 mm



Castroviejo
01-146 8 cm, Str.
Eye View Caliper
Measuring range, 20 mm
01-147 8 cm, Cvd.
Measuring range, 20 mm



Castroviejo
01-148 8 cm
Eye View Caliper
Measuring range
20 mm



Tonometer
01-149
Set

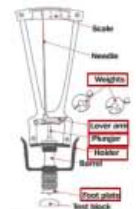

TROCARS, SUCTION TUBES, NEEDLE AND PROBES

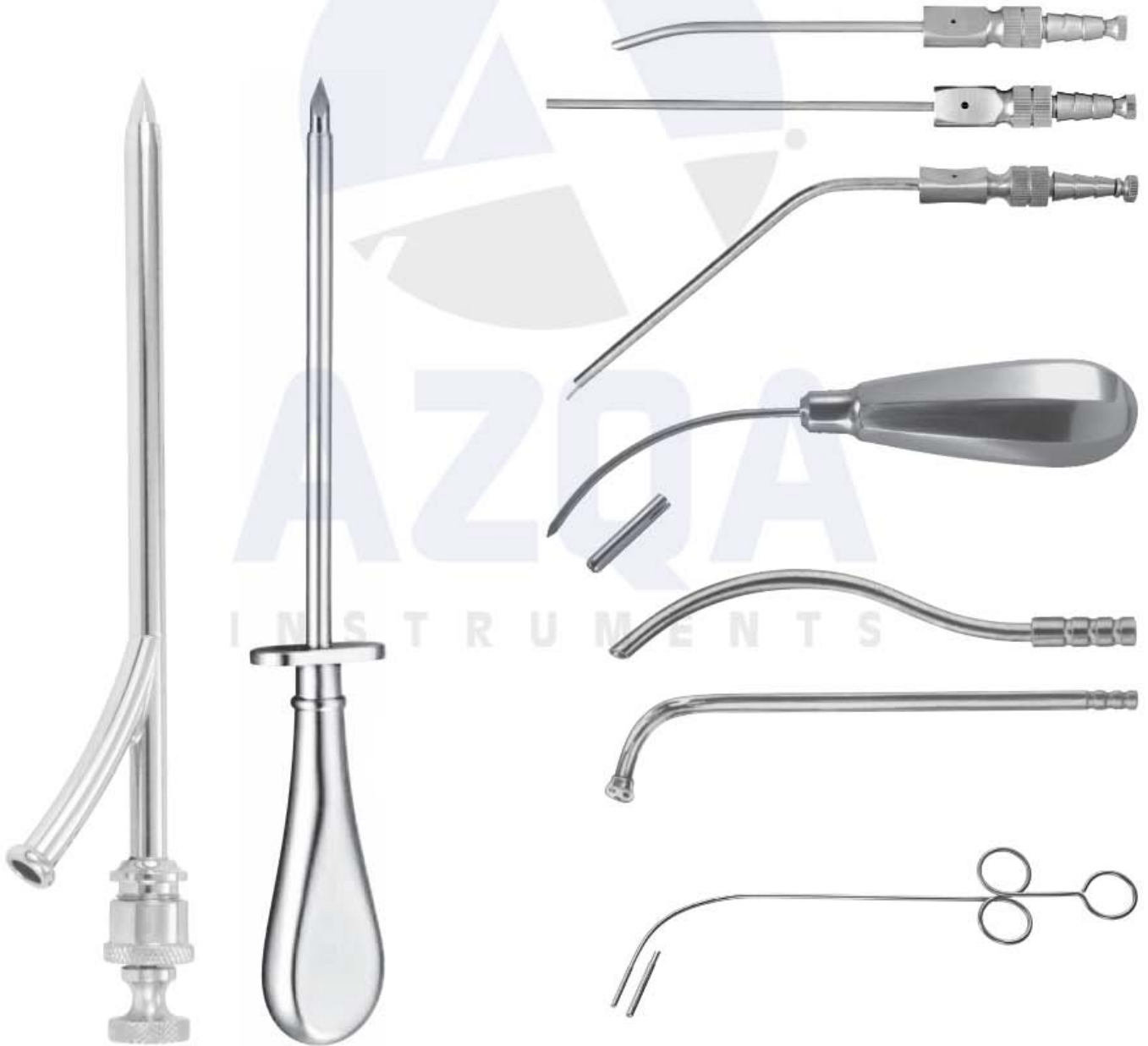



Cap Only



Fig. 1 02-03 1.7 mm Ø
Fig. 2 02-04 3 mm Ø
Fig. 3 02-05 4.5 mm Ø
Fig. 4 02-06 6 mm Ø

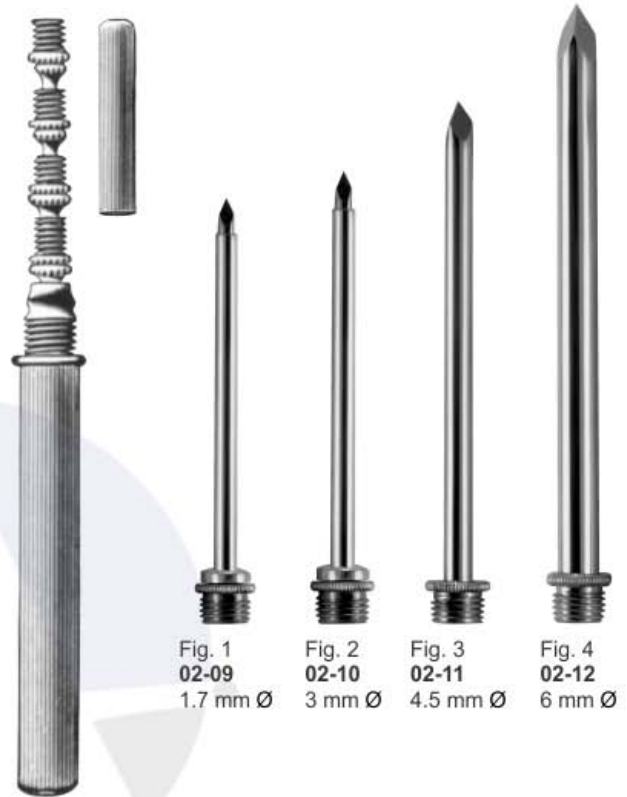

Fig. 1 02-09 1.7 mm Ø
Fig. 2 02-10 3 mm Ø
Fig. 3 02-11 4.5 mm Ø
Fig. 4 02-12 6 mm Ø

Universal Abdominal Trocar Set
02-01
(Handle with 4 needles) 14 cm
Fig. 1.7 mm Ø to 6 mm Ø
02-02
Only Handle

Universal Abdominal Trocar Set
02-07
(Handle with 4 needles) 14 cm
Fig. 1.7 mm Ø to 6 mm Ø
02-08
Only Handle



Luer, Trocar
02-13
Luer Lock Adapter

Uckermann Trocar
02-14 13cm

Sinuscopy Trocar
17cm

3.5mm Ø **02-15**
5.0mm Ø **02-16**
5.0mm Ø **02-17**

Nelson Trocar Thorax
21cm

02-18
6.0mmØ

02-19
8.3mmØ

02-20
9.5mmØ

02-21
11.6mmØ



Lichtwitz
Antrum Trocar
19 cm



Complete
02-22
1.8mm Ø
02-23
2.0mm Ø



Landau, Trocar
02-24 2.0mmØ
16cm



Ochsner
Trocar Thorax
10cm

- 02-25** 3 1/3 mm Ø
- 02-26** 4 mm Ø
- 02-27** 4 2/3 mm Ø
- 02-28** 5 1/3 mm Ø
- 02-29** 6 mm Ø
- 02-30** 6 2/3 mm Ø
- 02-31** 7 1/3 mm Ø
- 02-32** 8 mm Ø
- 02-33** 8 2/3 mm Ø
- 02-34** 9 1/3 mm Ø



Pierce
Antrum Trocar
17cm

- 02-35**
3.0mm Ø
- 02-36**
4.0mm Ø
- 02-37**
5.0mm Ø



Krause, Trocar
02-38 15cm
5.5mm Ø



Coakley, Trocar
02-39 16cm
2.25mm Ø



Duke Trocar
02-40 11cm
5.5mmØ



Douglas Trocar
02-41 12cm
3mm



Trocar
02-42
11 cm



Birch Trocar
02-43 18cm
4.5mm



Trocar
02-44



Buelau, Trocar
02-45 8 mm
24 cm



Fleurant Trocar
02-46 23cm
5 mm Ø

Fleurant Trocar
02-47 23cm
5mm Ø

Fleurant Trocar
02-48 23cm
5 mm Ø



Pool
02-49 22.5 cm
Suction cannula with
outer tube to be screwed

SUCTION TUBES

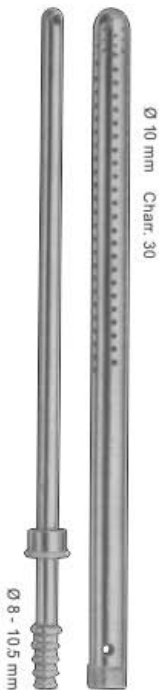

Pool
02-50 22.5 cm
Suction cannula with
outer tube to be screwed



02-51 18 cm
for tonsillectomy,
oral and laryngeal
operations



02-52 22 cm
Suction Cannula for
tonsillectomy, oral
and laryngeal operations



02-53 18 cm
suction cannula for
tonsillectomy, oral
and laryngeal operations



02-54 17 cm
S-shaped blunt cannula
for aspirating fluid from
the excretory ducts of
large glands and for
keeping the operations
area clear

 <p>Cooley, Suction Tube 02-55 18 cm 6mm Ø</p>	 <p>Cooley, Suction Tube 02-56 18 cm 7mm Ø</p>	 <p>Cooley, Suction Tube 02-57 18 cm 09mm Ø</p>	 <p>Cooley, Suction Tube 02-58 32.7 cm 9mm Ø Curved</p>	 <p>Andrews-Pyncheon Suction Tube 02-59 23.5 cm</p>
 <p>Yankauer Suction Tube 02-62 31 cm, 15 cm 2.5 cm, 10 cm</p>	 <p>Yankauer Suction Tube 02-63 31 cm, 15 cm 2.5 cm, 10 cm</p>	 <p>De Bakey suction tube 02-64 27.5 cm</p>	 <p>Yankauer Suction Tube 02-65 27 cm Baby Yankauer 02-66 21 cm</p>	 <p>Coupland Suction Tube 02-67</p>
 <p>Adson suction tubes 02-71 4 mm Ø 15 cm</p>	 <p>Adson suction tubes 21 cm 02-72 4 mm Ø 12 Charr./Fr 02-73 5 mm Ø 15 Charr./Fr</p>	 <p>02-74 Wullstein Suction Tube Complete</p>	 <p>Gorney Suction Tubes 02-75 18 cm suction dissector</p>	 <p>Landolt Dissecting Suction Tubes 02-76 4 mm wide 02-77 5 mm wide 20 cm suction raspatories, sharp,</p>
<p>17</p>	<p>www.azqainstruments.com</p>	<p>E-mail: azqa.instruments@gmail.com</p>	<p>info@azqainstruments.com</p>	<p>info@azqainstruments.com</p>

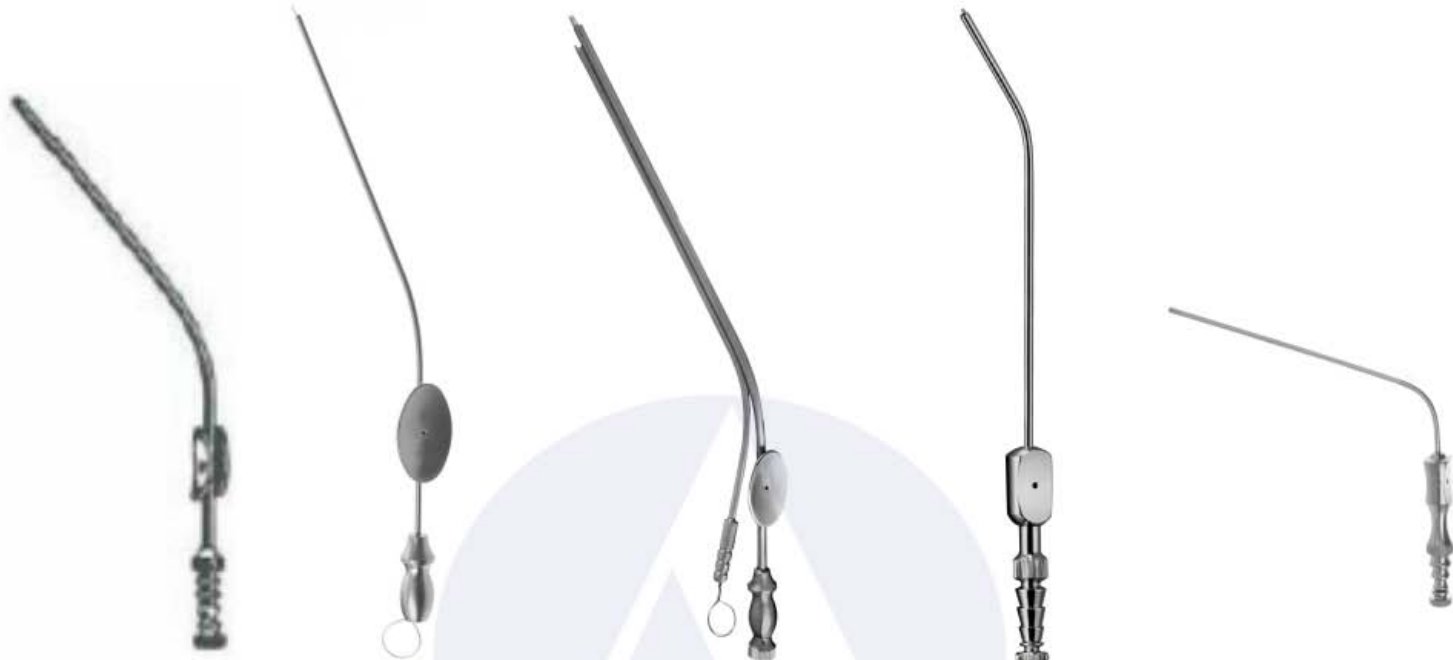

Plester Daumenplatt
02-79 6 Charr./Fr.
02-80 7 Charr./Fr.
02-81 8 Charr./Fr.
02-82 9 Charr./Fr.
02-83 10 Charr./Fr.
02-84 11 Charr./Fr.
02-85 12 Charr./Fr.
02-86 15 Charr./Fr.

Baron suction tubes 7.5 cm
02-87 1 mm Ø 3 Charr./Fr.
02-88 1 2/3 mm Ø 5 Charr./Fr.
02-89 2 1/3 mm Ø 7 Charr./Fr.

Baron suction tubes 10 cm
02-90 1 mm Ø 3 Charr./Fr.
02-91 1 2/3 mm Ø 5 Charr./Fr.
02-92 2 1/3 mm Ø 7 Charr./Fr.

House suction tubes 7.5 cm
02-93 1 mm Ø 3 Charr./Fr.
02-94 1 2/3 mm Ø 5 Charr./Fr.
02-95 2 1/3 mm Ø 7 Charr./Fr.
02-96 2 2/3 mm Ø 8 Charr./Fr.
02-97 3 1/3 mm Ø 10 Charr./Fr.
02-98 4 mm Ø 12 Charr./Fr.
02-99 4 2/3 mm Ø 14 Charr./Fr.

Plester Suction Tubes 17 cm
02-107 2.0 mm Ø 6 Charr./Fr.
02-108 2.3 mm Ø 7 Charr./Fr.
02-109 2.5 mm Ø 8 Charr./Fr.
02-110 3.0 mm Ø 9 Charr./Fr.
02-111 3.3 mm Ø 10 Charr./Fr.
02-112 3.5 mm Ø 11 Charr./Fr.
02-113 4.5 mm Ø 12 Charr./Fr.
02-114 5.0 mm Ø 15 Charr./Fr.

Fergusson Suction Tubes 17 cm
02-115 2.0 mm Ø 6 Charr./Fr.
02-116 2.3 mm Ø 7 Charr./Fr.
02-117 2.5 mm Ø 8 Charr./Fr.
02-118 3.0 mm Ø 9 Charr./Fr.
02-119 3.3 mm Ø 10 Charr./Fr.
02-120 3.5 mm Ø 11 Charr./Fr.
02-121 4.5 mm Ø 12 Charr./Fr.
02-122 5.0 mm Ø 15 Charr./Fr.

House suction tubes 10 cm
02-100 1 mm Ø 3 Charr./Fr.
02-101 1 2/3 mm Ø 5 Charr./Fr.
02-102 2 1/3 mm Ø 7 Charr./Fr.
02-103 2 2/3 mm Ø 8 Charr./Fr.
02-104 3 1/3 mm Ø 10 Charr./Fr.
02-105 4 mm Ø 12 Charr./Fr.
02-106 4 2/3 mm Ø 14 Charr./Fr.



FRAZIER
suction tubes
02-123 6 Fr.
02-124 7 Fr.
02-125 8 Fr.
02-126 9 Fr.
02-127 10 Fr.
02-128 11 Fr.
02-129 12 Fr.
02-130 13 Fr.
02-131 15 Fr.
 19 cm

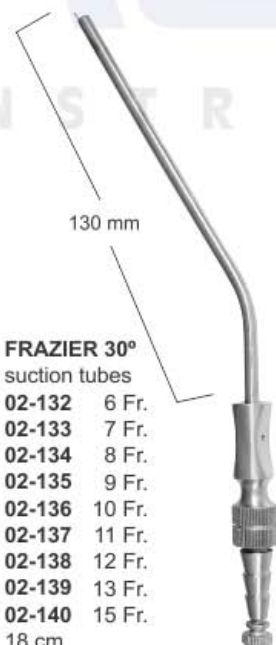

FRAZIER 30°
suction tubes
02-132 6 Fr.
02-133 7 Fr.
02-134 8 Fr.
02-135 9 Fr.
02-136 10 Fr.
02-137 11 Fr.
02-138 12 Fr.
02-139 13 Fr.
02-140 15 Fr.
 18 cm



FRAZIER 45°
suction tubes
02-141 6 Fr.
02-142 7 Fr.
02-143 8 Fr.
02-144 9 Fr.
02-145 10 Fr.
02-146 11 Fr.
02-147 12 Fr.
 18 cm

Cannula

- 02-148** ○ 6fr
- 02-149** ○ 7fr
- 02-150** ○ 8fr
- 02-151** ○ 9fr
- 02-152** ○ 10fr
- 02-153** ○ 11fr
- 02-154** ○ 12fr
- 02-155** ○ 13fr
- 02-156** ○ 14fr





Luer
02-157
 Suction Tube working
 length 110 mm



Nasal Suction Tubes
02-158 Ø 4.5 mm
02-159 Ø 5.5 mm
 17.5 cm



**Eicken
 Suction &
 Irrigation Cannula**
02-160 2.5 mm Ø
02-161 3.0 mm Ø
 Slightly curved



**Eicken
 Suction &
 Irrigation Cannula**
02-162 2.5 mm Ø
02-163 3.0 mm Ø
 Strongly curved



**Tonsil Needle
 Suction &
 Irrigation Cannula**
02-164 0.8 mm Ø
 Straight



**Tonsil Needle
 Suction &
 Irrigation Cannula**
02-165 0.8 mm Ø
 Curved



**Septum Needle
 Suction &
 Irrigation Cannula**
02-166 0.8 mm Ø
 bayonet



**Septum Needle
 Suction &
 Irrigation Cannula**
02-167 0.8 mm Ø
 angled on flat



**Luer-Lock Suction &
 Irrigation Cannula**
02-168 3.0 mm Ø



**Luer-Lock Suction &
 Irrigation Cannula**
02-169 2.5 mm Ø



**Fisch Suction &
 Irrigation Cannula**
02-170 4.0 mm Ø

I N S T R U M E N T S

Probe, Double Ended

- 1.0 mm Ø
- 02-171** 11.5cm
- 02-172** 13.0cm
- 02-173** 14.5cm
- 02-174** 16.0cm
- 02-175** 18.0cm
- 02-176** 20.0cm
- 02-177** 25.0cm

Probe, Double Ended

- 1.5 mm Ø
- 02-178** 11.5cm
- 02-179** 13.0cm
- 02-180** 14.5cm
- 02-181** 16.0cm
- 02-182** 18.0cm
- 02-183** 20.0cm
- 02-184** 25.0cm

Probe, Double Ended

- 2.0 mm Ø
- 02-185** 11.5cm
- 02-186** 13.0cm
- 02-187** 14.5cm
- 02-188** 16.0cm
- 02-189** 18.0cm
- 02-190** 20.0cm
- 02-191** 25.0cm

Probe With Eye

- 2.0mm Ø
 - 02-192** 11.5cm
 - 02-193** 13.0cm
 - 02-194** 14.5cm
 - 02-195** 16.0cm
 - 02-196** 18.0cm
 - 02-197** 20.0cm
 - 02-198** 25.0cm
- with eyelet

Probe

- 2.0mm Ø
 - 02-199** 11.5cm
 - 02-200** 13.0cm
 - 02-201** 14.5cm
 - 02-202** 16.0cm
- myrtle-shaped

Ohrkatheter
Sondes auriculaires

Sondas auriculares
Sonde auricolari



Fig. 0
02-211



Fig. 1
02-212



Fig. 2
02-213



Fig. 3
02-214



Fig. 4
02-215



Fig. 5
02-216

Hartmann, Eustachian Catheters
Fig. 1
02-203 2.0 mm Ø
02-204 2.5 mm Ø
02-205 3.0 mm Ø

Hartmann Eustachian Catheters
Fig. 2
02-206 2.0 mm Ø
02-207 2.5 mm Ø
02-208 3.0 mm Ø

Killian, Eustachian Catheters
02-209 16 cm 2.5 mm Ø
02-210 16 cm 3.0 mm Ø
oval opening

Hartmann Eustachian Catheters
15cm



Trötsch Eustachian Catheters 15cm



02-217
Tube end piece for eustachian catheter



Fig. 2
02-219



Fig. 4
02-221



Fig. 1
02-218



Fig. 3
02-220



Fig. 5
02-222



Zöllner, Suction Tube
02-223 0.7mm Ø
complete with 1 slip-on cannula, 0.7mm Ø



Iowa, Suction Tube
02-224 0.7mm Ø
16cm



Rosen Suction Tube
X=80 mm
02-225 0.7mm Ø
02-226 0.9mm Ø
02-227 1.2mm Ø



ROSEN, Suction Tube
X=65 mm
02-228 0.7mm Ø
02-229 0.9mm Ø
02-230 1.2mm Ø



Magill Suction Tube
24.5cm
02-231 3.0mm Ø
02-232 3.5mm Ø
02-233 4.0mm Ø



Suction Tube, Guide Needle
19.5cm
02-234 2.2/3mmØ 8 Charr./Fr.
02-235 3.1/3mmØ 10 Charr./Fr.
02-236 4mmØ 12 Charr./Fr.
02-237 4 2/3mmØ 14 Charr./Fr.
02-238 5 1/3mmØ 16 Charr./Fr.
02-239 6mmØ 18 Charr./Fr.



Suction Tube, Guide Needle
19.5cm
02-240 2mmØ 6 Charr./Fr.
02-241 2.2/3mmØ 8 Charr./Fr.
02-242 3 1/3mmØ 10 Charr./Fr.
02-243 4mmØ 12 Charr./Fr.
02-244 4 2/3mmØ 14 Charr./Fr.
02-245 5 1/3mmØ 16 Charr./Fr.
02-246 6 1/3mmØ 18 Charr./Fr.



Suction Tube, Guide Needle
19.5cm
Lancet Tip 19.5cm
02-247 2.2/3mmØ 8 Charr./Fr.
02-248 3.1/3mmØ 10 Charr./Fr.
02-249 4mmØ 12 Charr./Fr.
02-250 4 2/3mmØ 14 Charr./Fr.
02-251 5 1/3mmØ 16 Charr./Fr.
02-252 6mmØ 18 Charr./Fr.

**Butterfly Grooved Director
With Tongue Tie Plain End**

- 02-253 11.5cm
- 02-254 13.0cm
- 02-255 14.5cm
- 02-256 16.0cm
- 02-257 18.0cm
- 02-258 20.0cm



**Butterfly Grooved Director
With Tongue Tie Plain End**

- 02-259 11.5cm
- 02-260 13.0cm
- 02-261 14.5cm
- 02-262 16.0cm
- 02-263 18.0cm
- 02-264 20.0cm



**Doyen
Probes &
Directors
02-265
14cm**



**Nélaton
Probes &
Directors
02-266
16cm**



**Directors
02-267 13cm
02-268 14.5cm
02-269 16cm
Larry Probe
and Grooved
Director,
17.8 cm**



**Doyen
02-270
14.5cm**



**Nélaton
02-271
16cm**



**Director Probe
End
02-272 14cm
Director with tip
Diam. of tip
3.3 mm**



**Brodie
02-273 20cm
Director with
tip Diam. of
tip 3.5 mm**



**Lockhart-
Mummery
02-274
16.5cm**



**Lockhart-
Mummery
02-275
16.5cm**



**Lockhart-
Mummery
02-276
16.5cm**

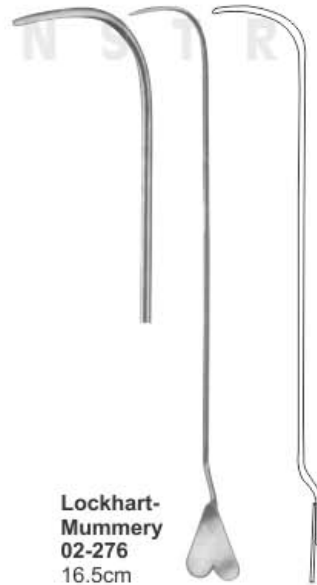

**Lockhart-
Mummery
02-277
16.5cm**

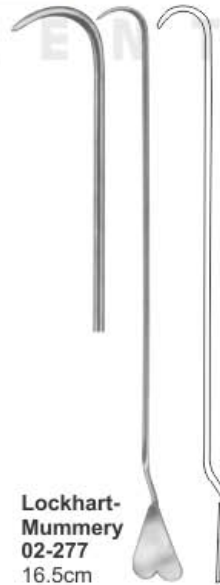

**Director
with wire
loop,
malleable
02-278
19cm**



COTTON APPLICATORS



Jopson-Horne
Cotton Applicator
02-279 18cm



Fein Cotton
Applicator
02-280 28cm



Pelteson Cotton
Applicator
02-281 23cm



Barr Fistula Probe
02-282
with 20.3cm sterling shaft,
eye at tip, 29.2cm overall



Barr Crypt Hook
02-283
25.4cm short and
long hook ends



Buie Suction Tube
02-284
45 cm with finger
valve, 15 Fr. (5 mm)

Bowman Lacrimal Probes Double Ended, Sterling Silver



02-285
Bowman Probe,
000-0000



02-286
Bowman Probe,
00-0



02-287
Bowman Probe,
1-2



02-288
Bowman Probe,
3-4



02-289
Bowman Probe,
5-6



02-290
Bowman Probe,
7-8

William Lacrimal Probes Double Ended, Sterling Silver



02-291
William Probe,
000-0000



02-292
William Probe,
00-0



02-293
William Probe,
1-2



02-294
William Probe,
3-4



02-295
William Probe,
5-6



02-296
William Probe,
7-8

Sonden	Sondas y estiletos
Sondes et stylets	Specilli e sonde



Biolvar
02-297 15cm
02-298 18cm
02-299 20cm

Desjardim
02-300
18cm
(Set 3 Pieces)

Probes With Eye
02-301 14.5cm
02-302 16.0cm
02-303 20.0cm

Myrtle Leaf Probe
02-304 14.5cm

Myrtle Leaf Probe
02-305 13.0cm
02-306 14.5cm
02-307 16.0cm
02-308 18.5cm
02-309 20.0cm

Probe
02-310

Wilder Lacrimal Dilator
02-311 10cm
medium taper

02-312 19cm
Double ended probe,
malleable, diam,
of tips 3 mm with hole

02-313 25cm
02-314 30cm
Double ended probes,
tin, malleable, diam,
of tips 3.5 mm with hole

02-315 40cm
Double ended probes,
tin, malleable, diam,
of tips 4 mm with hole

02-316 1.5 mm
02-317 2.0 mm
02-318 2.5 mm
30cm

Clips Mayo
02-319 14cm

Stacke
02-320
10cm

Killian
02-321
16.5cm

02-322
16.5cm

Seiffert
02-323
18cm

Modell Piccolo
02-324 11cm
Round Serrated

Modell Piccolo
02-325 11cm
Triangular Serrated
end

Farrell
02-326 11cm
Round Serrated
end

Lathbury-Farrel
02-327 11cm
Triangular Serrated
end

Spatula
02-328
14.5cm

Spatula
02-329
14.5cm

SCALPEL HANDLE, SCALPEL BLADES, DISSECTING KNIVES & SAWS



Skalpgriffe
Mangos de bisturios

Manches pour bisturios
Manici per bisturi



03-01
#3 Scalpel Handle
12.50 cm
Blade Size 10, 11,
12, 13, 15, 17



03-02
#3 Scalpel Handle/
Graduated 12.75 cm
Blade Size 10, 11,
12, 13, 15, 17



03-03
Scalpel Handle
#4 Graduated
with scale



03-04
#4 Scalpel Handle
12.75 cm Blade
Size 18, 20, 21, 22,
23, 24, 25, 60,70



03-05
#4 Scalpel Handle/
Graduated 12.75 cm
Blade Size 18, 20, 21,
22, 23, 24, 25, 60,70



03-06
4LA Scalpel Handle
21 cm Blade
Size 18, 20, 21, 22,
23, 24, 25, 60,70



03-07
#3, #4 Scalpel
Handle
Double Ended
16 cm



03-08
Scalpel Handle
3L Long 21 cm
Blade Size
10, 11, 12, 15, 17



03-09
#7 Scalpel
Handle
16.5 cm
Blade 10, 11,
12, 13, 15, 17



03-10
Fig. 10 - 17
12.5cm
Solid



03-11
Scalpel Handle
4L Long 21 cm
Blade
Size 18, 20, 21,
22, 23, 24, 25,
60,70



03-12
#3LA Scalpel
Handle / Long
Angled 20.25 cm
Blade Size
10, 11, 12, 15, 17



03-13
Knife Handle
(Smooth) for
Blades Nos.
60 and 70



03-14
Siegel Round
Scalpel Handle
#3 With Adjustable
Tip 16 cm
Blade Size 10,
11, 12, 13, 15,
17



03-15
Siegel Round
Scalpel Handle
#4 With Adjustable
Tip 16 cm
Blade Size 18, 20,
21, 22, 23, 24,
25, 60, 70



03-16
Round Knurled
Scalpel Handle
11.5 cm
Blade Size
50, 60 & 70



03-17
Round Knurled
Scalpel Handle
12.7 cm
Blade Size
50, 60 & 70



03-18
Round Knurled
Scalpel Handle
12.7 cm
Blade Size
50, 60 & 70



03-19
Round Knurled
Scalpel Handle
11 cm
Blade Size
50, 60 & 70



03-20
Round Knurled
Scalpel Handle
13.5 cm
Blade Size
50, 60 & 70



03-21
Beaver
Handle



03-22
Round Knurled
Scalpel Handle
12 cm



03-23
#3RK Kaye
Round Scalpel
Handle 15 cm,
Blade
Size 10, 11,
12, 13, 15, 17



03-24
#3R Corwin
Round Scalpel
Handle
14.5 cm
Blade Size 10,
11, 12, 15, 17



03-25
#4R Corwin Round
Scalpel Handle,
14.5 cm
Blade Size 18, 20,
21, 22, 23, 24,
25, 60, 70



03-26
#3RC Scalpel
Handle 14 cm,
Blade
Size 10, 11, 12
13, 15, 17



03-27
#3P Scalpel
Handle 15.5 cm,
Blade Size
10, 11, 12, 13,
15, 17



03-28
15.5cm
Blade Size
10 - 17
With Round
Hollow Handle



03-29
Scalpel
Handle



03-30
Scalpel Grip

Skalpelligriffe, Klingenbrecher
Poignées de scalpel, disjoncteurs de lame

Mangos de bisturí, rompe cuchillas
Manici per bisturí, rompitrama



03-31
Round Scalpel Handle, Double Head #3, Blade Size 10, 11, 12, 13, 15, 17

03-32
Beaver Handle

03-33
Scalpel Plastic Handle #8 Blade Size 18, 20, 21, 22, 23, 24, 25, 60,70

03-34
Collin Scalpel Handle # 9 Blade Size 10, 11, 12, 13, 15, 17

Fig. 10 Fig. 11
Blade Sizes

Fig. 12 Fig. 15

03-35
Scalpel Plastic Handle

03-36
Scalpel Plastic Handle # 5 Blade Size 10, 11, 12, 13, 15, 17

03-37
Scalpel Plastic Handle # 6 Blade Size 18, 20, 21, 22, 23, 24, 25, 60,70

Fig. 20

Fig. 22

RAZOR BLADE HOLDER & BREAKERS



03-38
Cole-Parmer Dissecting Blade Remover For Blade Handle

03-39
Troutman-Chris Blade Breaker & Holder with Push-Pull Lock 9 cm

03-40
Troutman-Chris Blade Breaker & Holder angled, with Push-Pull Lock 9 cm

03-41
Blade Holder Blade Breaker & Holder, with Ratchet Lock 11 cm

03-42
Castroviejo Blade Breaker & Holder, with Push-Pull Lock 13 cm

03-43
Razor Blade Breaker & Holder, Straight 18.5 cm



03-44
Sterile Scalpel
Blade Size # 6
Stainless Steel



03-45
Sterile Scalpel
Blade Size # 10
Stainless Steel



03-46
Sterile Scalpel
Blade Size # 10A
Stainless Steel



03-47
Sterile Scalpel
Blade Size # 11
Stainless Steel



03-48
Sterile Scalpel
Blade Size # 11P
Stainless Steel



03-49
Sterile Scalpel
Blade Size # E11
Stainless Steel



03-50
Sterile Scalpel
Blade Size # 12
Stainless Steel



03-51
Sterile Scalpel
Blade Size # 13
Stainless Steel



03-52
Sterile Scalpel
Blade Size # 15
Stainless Steel



03-53
Sterile Scalpel
Blade Size # 15A
Stainless Steel



03-54
Sterile Scalpel
Blade Size # 17
Stainless Steel



03-55
Sterile Scalpel
Blade Size # 18
Stainless Steel



03-56
Sterile Scalpel
Blade Size # 20
Stainless Steel



03-57
Sterile Scalpel
Blade Size # 21
Stainless Steel



03-58
Sterile Scalpel
Blade Size # 22
Stainless Steel



03-59
Sterile Scalpel
Blade Size # 23
Stainless Steel



03-60
Sterile Scalpel
Blade Size # 24
Stainless Steel



03-61
Sterile Scalpel
Blade Size # 25
Stainless Steel



03-62
Sterile Scalpel
Blade Size # 36
Stainless Steel



03-63
Sterile Scalpel
Blade Size # 40
Stainless Steel



03-64
Sterile Scalpel
Blade Size # 60
Stainless Steel



03-65
Sterile Scalpel
Blade Size # 70
Stainless Steel

DIEFFENBACH
16 cm

03-66
Fig. 1
16 cm

03-67
Fig. 2
16 cm

03-68
Fig. 3
16 cm

03-69
Fig. 4
16 cm

03-70
Fig. 5
16 cm

03-71
Fig. 6
16 cm

03-72
Fig. 7
16 cm

03-73
Fig. 8
16 cm

03-74
Fig. 9
16 cm

03-75
Fig. 10
16 cm

03-76
Fig. 15
16 cm

03-77
Fig. 16
16 cm

Collin Dissecting Knives
14.5 cm

03-78
Fig. 1
14.5 cm

03-79
Fig. 2
14.5 cm

03-80
Fig. 3
14.5 cm

03-84
Fig. 1
13.5 cm

03-85
Fig. 2
13.5 cm

03-86
Fig. 3
13.5 cm

03-87
Fig. 4
13.5 cm

03-88
Fig. 5
13.5 cm

03-89
Fig. 6
13.5 cm

03-81
Fig. 4
14.5 cm

03-82
Fig. 5
14.5 cm

03-83
Fig. 6
14.5 cm

Dieffenbach Dissecting Knives
13.5 cm

03-90
Fig. 7
13.5 cm

03-91
Fig. 8
13.5 cm

03-92
Fig. 9
13.5 cm

03-93
Fig. 10
13.5 cm



Dissecting Knives
17 cm



DISSECTING KNIVES



DISSECTING KNIFE
15 cm
with metal handle

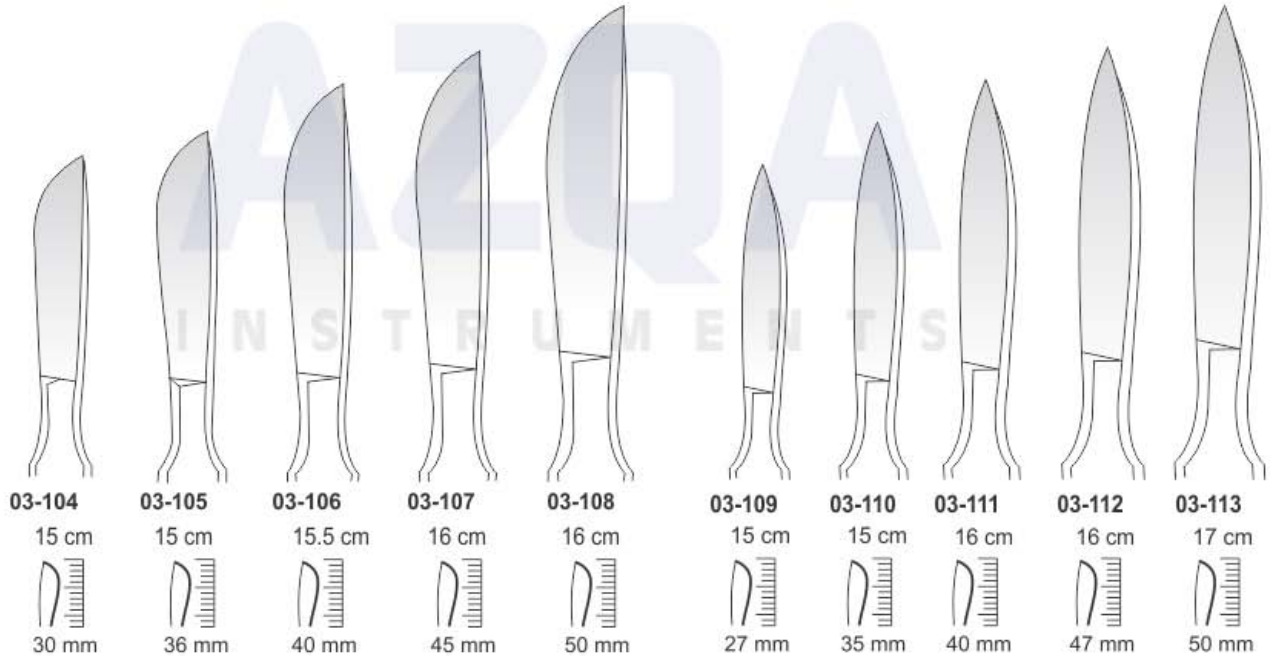

Anatomische skalpelle
Bisturías para disección

Bistouris à dissection
Bisturi para dissezione



Collin Dissecting Knives Blade Size
03-114 13 cm
03-115 16 cm
03-116 19 cm
03-117 22 cm
03-118 28 cm

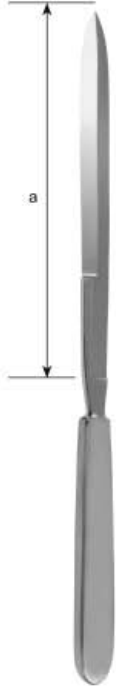

Catlin Dissecting Knives Blade Size
03-119 16 cm
03-120 19 cm
03-121 22 cm

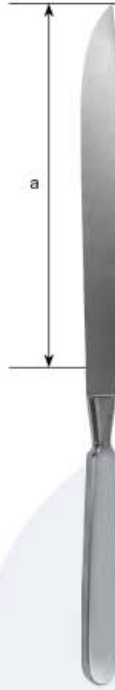

Liston Dissecting Knives Blade Size
03-122 16 cm
03-123 19 cm
03-124 22 cm



Langenbeck Dissecting Knives Blade
03-125 12 cm



Amputation Knife
03-126 29 cm



Amputation Knife
03-127 32.5 cm



Catlin Amputation
03-128 29 cm



Resection Knife
03-129 18 cm



Langenbeck Amputation
03-130 18 cm



Langenbeck Amputation
03-131 18 cm



Dieffenbach Dissecting Knives
03-132 13 cm



Dieffenbach Dissecting Knives
03-133 13 cm



Simon Dissecting Knives
23.5 cm



03-134 Fig.1



03-135 Fig. 2



03-136 Fig. 3



03-137 Fig. 4

Anatomische skalpelle
Bisturías para disección

Bistouris à dissection
Bisturi para dissezione



Autopsy Knife
03-138
25.5 cm



Walb Dissecting Knives
03-139
11 cm



Walb Dissecting Knives
03-140
14 cm



Walb Dissecting Knives
03-141
17 cm



Virchow Dissecting Knives
03-142
16 cm



Virchow Dissecting Knives
03-143
20 cm



Virchow Dissecting Knives
03-144
24 cm



Ayre Cone Knife
03-145
23.5 cm



Cone Knife
03-146
23 cm



Segond Myomatome
03-147
27 cm



Olivecrona Trigeminal knife
03-148
20.5 cm



Trigeminal knife
03-149
23 cm



Fowler Tonsil Knife
03-150
20 cm



Abraham Tonsil Knife
03-151
21.5 cm



Brunings Tonsil knife
03-152
21.5 cm

Dermatome - Transplantationsmesser

Dermatomos - Cuchillos para trasplantaciones

Dermatomes - Bistouries pour transplantation

Dermatomi - coltello per trapianto

AMPUTATION KNIVES & RESECTION SAWS

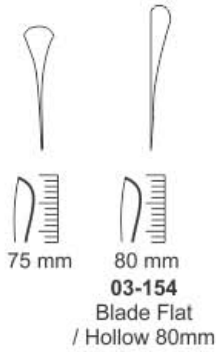

RAZOR HOLLOW
Blades On
Both Sides
Blade Flat / Hollow
03-153



**Charriere Amputation
& Resection**
03-155 27cm
03-156 30cm



**Charriere Amputation
& Resection**
03-157 35cm



**Satterlee Amputation
& Resection**
03-158 31cm



Thiersch
03-159
20 cm



Schink
03-160 30cm
Complete with 1
Blade & 2 plates



03-161
Spare Blade



03-162
Skin fixing plate



Humby Dermatomes
03-163 31cm
Complete with 1 Blade



03-164
spare blade



Watson Dermatomes
03-165 30cm
Complete with 1 Blade,
fixed bar



Silver Dermatomes
03-166 19cm

GENERAL OPERATING SCISSORS



Operating Scissors (Flat Pattern)

Operating Scissors

04-001	11.5 cm	S/S Str.
04-002	12.5 cm	S/S Str.
04-003	13 cm	S/S Str.
04-004	14.5 cm	S/S Str.
04-005	16 cm	S/S Str.
04-006	18 cm	S/S Str.
04-007	20 cm	S/S Str.
04-008	23 cm	S/S Str.
04-009	25 cm	S/S Str.
04-010	28 cm	S/S Str.
04-011	30 cm	S/S Str.

Operating Scissors

04-012	11.5 cm	S/S Cvd
04-013	12.5 cm	S/S Cvd
04-014	13cm	S/S Cvd
04-015	14.5 cm	S/S Cvd
04-016	16 cm	S/S Cvd
04-017	18 cm	S/S Cvd
04-018	20 cm	S/S Cvd
04-019	23 cm	S/S Cvd
04-020	25 cm	S/S Cvd
04-021	28 cm	S/S Cvd
04-022	30 cm	S/S Cvd

Operating Scissors

04-023	11.5 cm	B/B Str.
04-024	12.5 cm	B/B Str.
04-025	13 cm	B/B Str.
04-026	14.5 cm	B/B Str.
04-027	16 cm	B/B Str.
04-028	18 cm	B/B Str.
04-029	20 cm	B/B Str.
04-030	23 cm	B/B Str.
04-031	25 cm	B/B Str.
04-032	28 cm	B/B Str.
04-033	30 cm	B/B Str.

Operating Scissors

04-034	11.5 cm	B/B Cvd
04-035	12.5 cm	B/B Cvd
04-036	13 cm	B/B Cvd
04-037	14.5 cm	B/B Cvd
04-038	16 cm	B/B Cvd
04-039	18 cm	B/B Cvd
04-040	20 cm	B/B Cvd
04-041	23 cm	B/B Cvd
04-042	25 cm	B/B Cvd
04-043	28 cm	B/B Cvd
04-044	30 cm	B/B Cvd

Operating Scissors

04-045	11.5 cm	S/B Str.
04-046	12.5 cm	S/B Str.
04-047	13 cm	S/B Str.
04-048	14.5 cm	S/B Str.
04-049	16 cm	S/B Str.
04-050	18 cm	S/B Str.
04-051	20 cm	S/B Str.
04-052	23 cm	S/B Str.
04-053	25 cm	S/B Str.
04-054	28 cm	S/B Str.
04-055	30 cm	S/B Str.

Operating Scissors

04-056	11.5 cm	S/B Cvd
04-057	12.5 cm	S/B Cvd
04-058	13 cm	S/B Cvd
04-059	14.5 cm	S/B Cvd
04-060	16 cm	S/B Cvd
04-061	18 cm	S/B Cvd
04-062	20 cm	S/B Cvd
04-063	23 cm	S/B Cvd
04-064	25 cm	S/B Cvd
04-065	28 cm	S/B Cvd
04-066	30 cm	S/B Cvd

Operating Scissors

04-067	11.5 cm	S/S Str.
04-068	12.5 cm	S/S Str.
04-069	13 cm	S/S Str.
04-070	14.5 cm	S/S Str.
04-071	16 cm	S/S Str.
04-072	18 cm	S/S Str.
04-073	20 cm	S/S Str.
04-074	23 cm	S/S Str.
04-075	25 cm	S/S Str.
04-076	28 cm	S/S Str.
04-077	30 cm	S/S Str.

Operating Scissors

04-078	11.5 cm	S/S Cvd
04-079	12.5 cm	S/S Cvd
04-080	13 cm	S/S Cvd
04-081	14.5 cm	S/S Cvd
04-082	16 cm	S/S Cvd
04-083	18 cm	S/S Cvd
04-084	20 cm	S/S Cvd
04-085	23 cm	S/S Cvd
04-086	25 cm	S/S Cvd
04-087	28 cm	S/S Cvd
04-088	30 cm	S/S Cvd

Operating Scissors

04-089	11.5 cm	B/B Str.
04-090	12.5 cm	B/B Str.
04-091	13 cm	B/B Str.
04-092	14.5 cm	B/B Str.
04-093	16 cm	B/B Str.
04-094	18 cm	B/B Str.
04-095	20 cm	B/B Str.
04-096	23 cm	B/B Str.
04-097	25 cm	B/B Str.
04-098	28 cm	B/B Str.
04-099	30 cm	B/B Str.

Operating Scissors

04-100	11.5 cm	B/B Cvd
04-101	12.5 cm	B/B Cvd
04-102	13 cm	B/B Cvd
04-103	14.5 cm	B/B Cvd
04-104	16 cm	B/B Cvd
04-105	18 cm	B/B Cvd
04-106	20 cm	B/B Cvd
04-107	23 cm	B/B Cvd
04-108	25 cm	B/B Cvd
04-109	28 cm	B/B Cvd
04-110	30 cm	B/B Cvd

Operating Scissors

04-111	11.5 cm	S/B Str.
04-112	12.5 cm	S/B Str.
04-113	13 cm	S/B Str.
04-114	14.5 cm	S/B Str.
04-115	16 cm	S/B Str.
04-116	18 cm	S/B Str.
04-117	20 cm	S/B Str.
04-118	23 cm	S/B Str.
04-119	25 cm	S/B Str.
04-120	28 cm	S/B Str.
04-121	30 cm	S/B Str.

Operating Scissors

04-122	11.5 cm	S/B Cvd
04-123	12.5 cm	S/B Cvd
04-124	13 cm	S/B Cvd
04-125	14.5 cm	S/B Cvd
04-126	16 cm	S/B Cvd
04-127	18 cm	S/B Cvd
04-128	20 cm	S/B Cvd
04-129	23 cm	S/B Cvd
04-130	25 cm	S/B Cvd
04-131	28 cm	S/B Cvd
04-132	30 cm	S/B Cvd



04-133
12.5 cm
B/B Str.

**LANDOLT OPERATING
SCISSORS**



04-134
12.5 cm
B/B Cvd.



**DEAVER OPERATING,
DISSECTING SCISSORS**



04-135
14.5 cm
S/B Str.



04-136
14.5 cm
S/B Cvd.

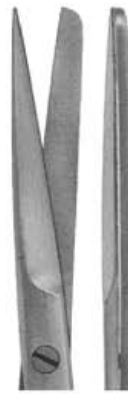

04-137
14.5 cm
S/B Str.
Saw Edge.



04-138
14.5 cm
S/B Cvd.
Saw Edge.



04-139
14.5 cm
S/B Str.

**LONGE OPERATING,
DISSECTING SCISSORS**



04-140
14.5 cm
S/B Cvd.



04-141
14.5 cm
S/B Str.
Saw Edge.



04-142
14.5 cm
S/S Cvd.
Saw Edge.



INCISION OPERATING SCISSORS



04-143 13.0 cm
04-144 14.5 cm
S/S Str.



04-145
 14.5 cm
04-146
 15.0 cm
04-147
 17.0 cm
04-148
 19.5 cm
04-149
 21.0 cm
04-150
 23.0 cm
 B/B, Str.



04-151
 14.5 cm
04-152
 15.0 cm
04-153
 17.0 cm
04-154
 19.5 cm
04-155
 21.0 cm
04-156
 23.0 cm
 B/B, Cvd.



04-157
 15.0 cm
04-158
 17.0 cm
04-159
 19.5 cm
04-160
 21.0 cm
 B/B, Str.



04-161
 15.0 cm
04-162
 17.0 cm
04-163
 19.5 cm
04-164
 21.0 cm
 B/B, Cvd.

MAYO DISSECTING & GYNECOLOGICAL SCISSORS

MAYO-STILLE DISSECTING & GYNECOLOGICAL SCISSORS



04-165
 22.5 cm
 B/B, Str.



04-166
 22.5 cm
 B/B, Cvd.



04-167
 17.0 cm
 B/B, Cvd.



04-168
 17.0 cm
 B/B, Str.

MAYO-HARRINGTON DISSECTING & GYNECOLOGICAL SCISSORS

MAYO-NOBLE DISSECTING & GYNECOLOGICAL SCISSORS

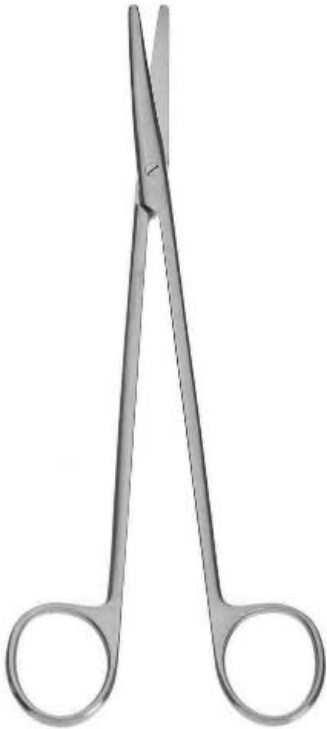

**METZENBAUM OPERATING,
DISSECTING SCISSORS
BLUNT/BLUNT STR.**



04-169
14.5 cm
B/B Str.



04-170
18 cm
B/B Str.



04-171
20 cm
B/B Str.



04-172
23 cm
B/B Str.



04-173
25 cm
B/B Str.



04-174
28 cm
B/B Str.



**METZENBAUM OPERATING,
DISSECTING SCISSORS
BLUNT/BLUNT CVD.**



04-175
14.5 cm
B/B Cvd.



04-176
18 cm
B/B Cvd.



04-177
20 cm
B/B Cvd.



04-178
23 cm
B/B Cvd.



04-179
25 cm
B/B Cvd.



04-180
28 cm
B/B Cvd.

**METZENBAUM-NELSON
SCISSORS**

04-181 18cm
04-182 20cm
04-183 23cm
04-184 25cm
04-185 28cm
04-186 30cm
B/B Str.



04-187 18cm
04-188 20cm
04-189 23cm
04-190 25cm
04-191 28cm
04-192 30cm
S/B Str.



04-193 18cm
04-194 20cm
04-195 23cm
04-196 25cm
04-197 28cm
04-198 30cm
S/S Str.

**METZENBAUM-NELSON
SCISSORS**

04-199 18cm
04-200 20cm
04-201 23cm
04-202 25cm
04-203 28cm
04-204 30cm
B/B Cvd.



04-205 18cm
04-206 20cm
04-207 23cm
04-208 25cm
04-209 28cm
04-210 30cm
S/B Cvd.



04-211 18cm
04-212 20cm
04-213 23cm
04-214 25cm
04-215 28cm
04-216 30cm
S/S Cvd.

**METZENBAUM-FINO
SCISSORS**

04-217
14.5 cm
B/B Str.



04-218
14.5 cm
S/S Str.



04-219
14.5 cm
B/B Cvd.



04-220
14.5 cm
S/S Cvd.

**METZENBAUM-FINO
SCISSORS**

04-221
18 cm
04-222
220 cm
04-223
230 cm
B/B Str.



04-224
18 cm
04-225
220 cm
04-226
230 cm
B/B Cvd.



04-227
18 cm
04-228
220 cm
04-229
230 cm
B/B Slightly
Cvd.



**RICHTER OPERATING,
 DISSECTING SCISSORS**
 04-230 14.5cm
 Angled



**JOSEPH OPERATING,
 DISSECTING SCISSORS**

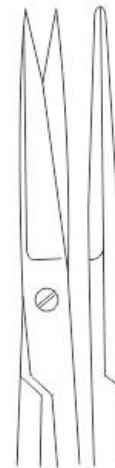

04-231
 14cm
 S/S Str.

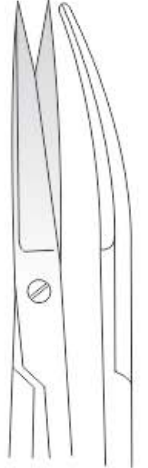

04-232
 14cm
 S/S Cvd



**KELLY OPERATING,
 DISSECTING SCISSORS**



04-233
 16cm
04-234
 18cm
 S/S Str.



04-235
 16cm
04-236
 18cm
 S/S Cvd.



**DOYEN OPERATING,
 DISSECTING SCISSORS**
 04-237 17.5 cm
 B/B, Str.



**DOYEN OPERATING,
 DISSECTING SCISSORS**
 04-238 17.5 cm
 B/B, Cvd.





SIMS DISSECTING & GYNECOLOGICAL SCISSORS

04-239 20cm
 04-240 23cm
 Str, B/B



04-241 20cm
 04-242 23cm
 Str, S/B



04-243 20cm
 04-244 23cm
 Str, S/S



04-245 20cm
 04-246 23cm
 Cvd, B/B



04-247 20cm
 04-248 23cm
 Cvd, S/B



04-249 20cm
 04-250 23cm
 Cvd, S/S



Iris Scissors



04-251 09 cm
 04-252 10.5 cm
 04-253 11.5 cm
 04-254 12.0 cm
 S/S Str.



04-255 09 cm
 04-256 10.5 cm
 04-257 11.5 cm
 04-258 12.0 cm
 S/S Cvd.



04-259
 11.5 cm
 Angular Left



04-262 9 cm
 04-263 10cm
 04-264 11.5cm
 04-265 12cm
 S/S Str.



04-260
 11.5 cm
 Laterally Cvd.



04-261
 11.5 cm
 Angular Right



Iris Scissors



04-266 9 cm
 04-267 10cm
 04-268 11.5cm
 04-269 12cm
 S/S Cvd.



VASCULAR SCISSORS
04-270 19cm
 S/S Angled 125°



COOLEY REVERSE CUT SCISSORS
04-271 17cm
 S/S angled 125°



POTTS-SMITH VASCULAR SCISSORS
 S/S Angled



04-272
 19cm
 25°



04-273
 19cm
 45°



04-274
 19cm
 60°



04-275
 19cm
 125°

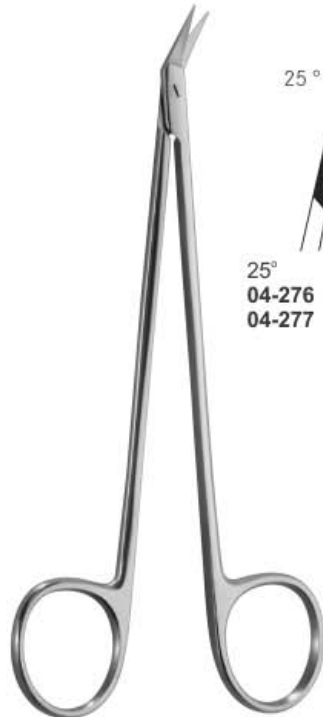

HEGEMANN-DIETRICH VASCULAR SCISSORS
 S/S Angled



04-276 16cm
04-277 19cm



04-278 16cm
04-279 19cm

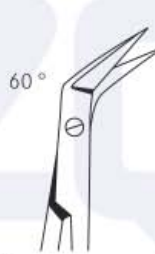

04-280 16cm
04-281 19cm



04-282 16cm
04-283 19cm



04-284 16cm
04-285 19cm



DE BAKHEY VASCULAR SCISSORS
 S/S Angled



04-286 16cm
04-287 19cm
04-288 23cm
04-289 28cm

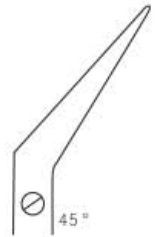

04-290 16cm
04-291 19cm
04-292 23cm
04-293 28cm

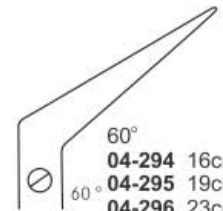

04-294 16cm
04-295 19cm
04-296 23cm
04-297 28cm

Gefäßschere
Tijeras vasculares

Ciseaux vasculaires
Forbici vascolari



O'BRIEN VASCULAR SCISSORS
04-298 9cm
S/S Angled

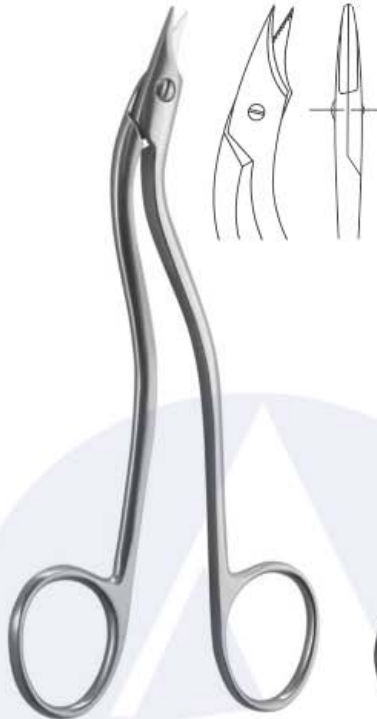

HEATH VASCULAR SCISSORS
04-299 15cm
S/S Double Cvd.



COOLEY VASCULAR SCISSORS
04-300 18.4 cm, 1 mm
04-301 18.4 cm, 1.5 mm
probe point on tip.
S/S Angled 45°

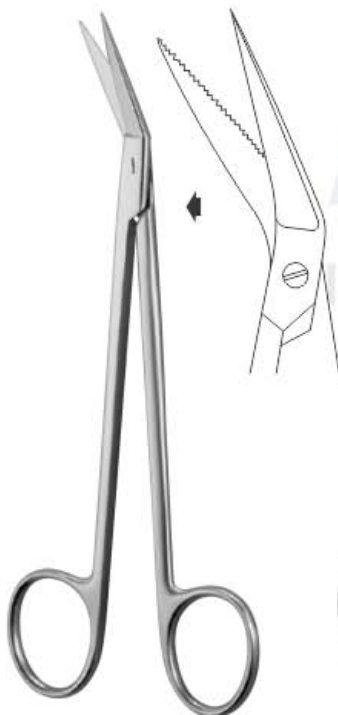

04-302
17cm
Serrated
Blade S/S
Double Cvd.

DISSECTING & NASAL SCISSORS

Locklin Dissecting Scissors
04-303 16.5cm
S/S

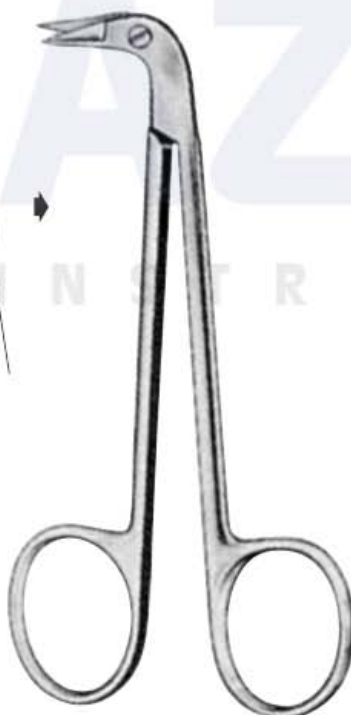

FAVALORO CORONARY
04-304 10.5 cm
S/S Angled 90°



ENT-DEAN SCISSORS
04-305 17cm
S/S Double Cvd.
Serrated



DE BAKKEY VASCULAR SCISSORS

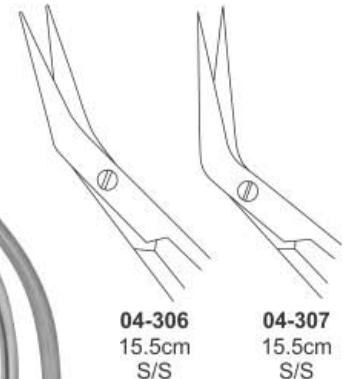

04-306
15.5cm
S/S

04-307
15.5cm
S/S



Saw Edge

STITCHES SCISSORS
04-308 12.0 cm
Str.

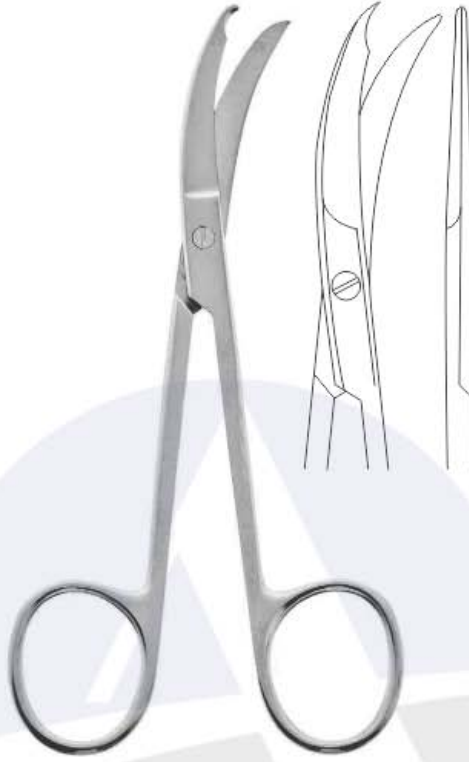

NORTHBENT STITCHES SCISSORS
04-309 12.5 cm
Cvd.

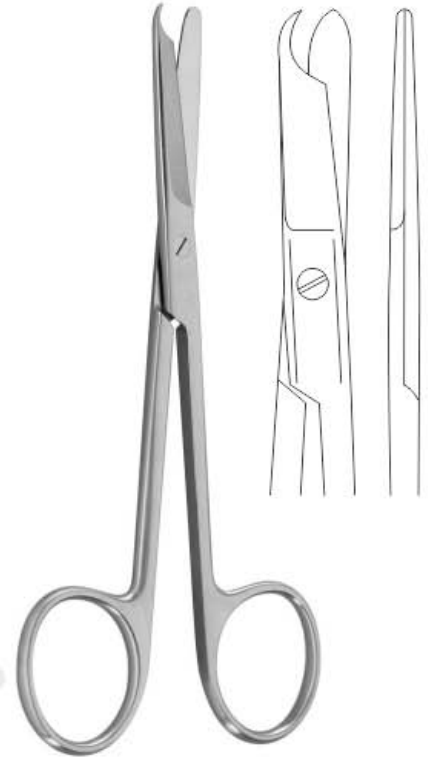

LITTAUER STITCH SCISSORS
04-310 14 cm
Str.



04-311
14.5 cm
Str.

BUCK STITCH SCISSORS



04-312
18.0 cm
Str.

SPENCER STITCH SCISSORS



04-313
9 cm
Str.

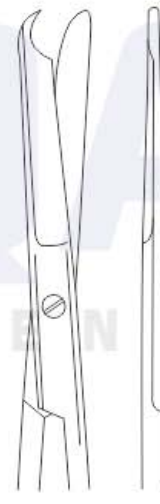

04-314
11.5 cm
Str.



SHORTBENT STITCH SCISSORS
04-315 9 cm
Cvd.

Tonsillensteine Schere, Nasenschere
Tijeras de amígdalas, tijeras nasales

Ciseaux d'amygdale, Ciseaux nasaux
Tonsille forbici, forbici nasali



COTTLE SCISSORS
04-316 16 cm
 B/B, Angled



FOMON SCISSORS
04-317 14.5 cm
 B/B, Angled



SAILER SCISSORS
04-318 17.0 cm
 B/B, Angled



HEYMANN SCISSORS
04-319 18 cm
04-320 19.5 cm
 B/B, Angled



HEYMANN SCISSORS
04-321 18.0 cm
 B/B, Angled



OLIVECRONA VASCULAR SCISSORS
04-322 23.0 cm
 B/B



GOOD SCISSORS
04-323 19.0 cm
Probe End, Cvd.



PRINCE SCISSORS
04-324 17.5 cm
B/B, Cvd.



HALLE SCISSORS
04-325 19.0 cm
B/B, Cvd.



04-326
14.5 cm
Pointed Tip
S/S, Str.



04-327
14.5 cm
Pointed Tip
S/S, Cvd.



MOD. BONN SCISSORS
04-328 8.0 cm
S/S, Str.



MOD. BONN SCISSORS
04-329 8.0 cm
S/S, Cvd.





04-330
10.5 cm
04-331
12.0 cm
B/B Str.
04-332
10.5 cm
04-333
12.0 cm
B/B Str.
Saw Edge



04-334
10.5 cm
04-335
12.0 cm
S/S Str.
04-336
10.5 cm
04-337
12.0 cm
S/S Str.
Saw Edge



04-338
10.0 cm
04-339
12.0 cm
B/B Cvd.
04-340
10.0 cm
04-341
12.0 cm
B/B Cvd.
Saw Edge

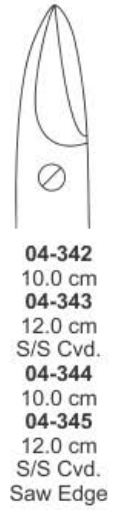

04-342
10.0 cm
04-343
12.0 cm
S/S Cvd.
04-344
10.0 cm
04-345
12.0 cm
S/S Cvd.
Saw Edge

BEEBEE WIRE CUTTING SCISSORS

BEEBEE WIRE CUTTING SCISSORS



SYSTRUNK
04-346
13.0 cm
S/S, Str.



SYSTRUNK
04-347
13.0 cm
S/S, Cvd.



SYSTRUNK SCISSORS



UNIVERSAL WIRE CUTTING SCISSORS
04-348 12 cm



04-349
10 cm
04-350
11.5 cm
S/S Str.

STEVENS SCISSORS



04-351
10 cm
04-352
11.5 cm
S/S Cvd.



STEVENS SCISSORS



04-353
10 cm
04-354
11.5 cm
B/B Str.



04-355
10 cm
04-356
11.5 cm
B/B Cvd.



NAIL SCISSORS
04-357 9 cm S/S, Cvd.



NAIL SCISSORS
04-358 9 cm
S/S, Cvd.



NAIL SCISSORS
04-359 9 cm
Arrow Point Curved



NAIL NIPPERS
04-360 11 cm
04-361 13 cm
04-362 15 cm



NAIL NIPPERS
04-363 14 cm



I N T R U M E N T S



NAIL NIPPERS
04-364 14 cm



TURNBULL NIPPERS
04-365 11.5 cm
04-366 13 cm



NAIL NIPPERS
04-367 10.5 cm



COHEN NIPPERS
04-368 10.5 cm



ARTERY SCISSORS
 Probe end Angled



04-369
 18.0 cm
 25°



04-370
 18.0 cm
 45°

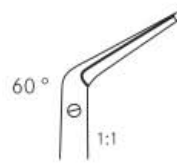

04-371
 18.0 cm
 60°

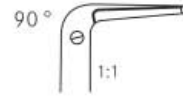

04-372
 18.0 cm
 90°

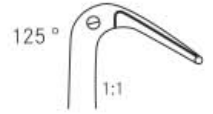

04-373
 18.0 cm
 125°



04-374
 18.0 cm
 25°



04-375
 18.0 cm
 45°



04-376
 18.0 cm
 60°



04-377
 18.0 cm
 90°



04-378
 18.0 cm
 125°



04-379
 9.0 cm
 S/B Str.



04-380
 9.0 cm
 S/B Cvd.



04-381
 9.0 cm
 S/S Str.



04-382
 9.0 cm
 S/S Cvd.



04-383
 11.4 cm
 B/B Str.



04-384
 11.4 cm
 B/B Cvd.



04-385
 11.4 cm
 S/B Str.



04-386
 11.4 cm
 S/B Cvd.



04-387
 11.4 cm
 S/S Str.



04-388
 11.4 cm
 S/S Cvd.



04-389
 14 cm
 B/B Str.



04-390
 14 cm
 B/B Cvd.



04-391
 14 cm
 S/B Str.



04-392
 14 cm
 S/B Cvd.



04-393
 14 cm
 S/S Str.



04-394
 14 cm
 S/S Cvd.



CASTROVIEJO SCISSORS
 Spring Type



04-395
12 cm
S/S



04-396
12 cm
S/B



04-397
12 cm
B/B



NOYES SCISSORS
Spring Handle
04-398 12cm
Angled,



WECKER SCISSORS
Angled



04-399
11.0 cm
S/B



04-400
11.0 cm
B/B



04-401
11.0 cm
S/S



BARRAQUER SCISSORS
04-402 Sharp Points
04-403 Blunt Points
5.5 cm



CASTROVIEJO CORNEAL MICRO SCISSORS
04-404 11cm
Left Angled,
Spring Handle



CASTROVIEJO CORNEAL MICRO SCISSORS
04-405 11cm
Right Angled,
Spring Handle



TROUTMAN MICRO SCISSORS
04-406 10cm
Left Angled,
Spring Handle



TROUTMAN MICRO SCISSORS
04-407 10cm
Right Angled,
Spring Handle



WESTCOTT MICRO SCISSORS



04-408
11.0 cm
S/S Str.



04-410
11.0 cm
S/S Cvd.

04-409
13.3 cm
S/S Str.

04-411
13.3 cm
S/S Cvd.



MICRO SCISSORS
 04-412 12cm
 S/S, Cvd.



MICRO SCISSORS
 S/S, Angled



04-413
 18.0 cm
 25°



04-414
 18.0 cm
 45°



04-415
 18.0 cm
 60°



MICRO SCISSORS
 S/S, Angled pointed probe



04-418
 18.0 cm
 25°



04-419
 18.0 cm
 45°

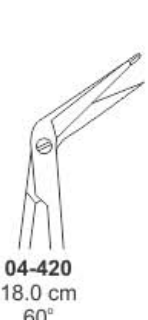

04-420
 18.0 cm
 60°



04-416
 18.0 cm
 90°



04-417
 18.0 cm
 125°



04-421
 18.0 cm
 90°



04-422
 18.0 cm
 125°



YASARGILL SCISSORS



04-423 16 cm
04-424 20 cm
04-425 22.5cm
 S/S, Str.



04-426 16cm
04-427 20cm
04-428 22cm
 S/S, Cvd.



04-429 16cm
04-430 20cm
04-431 22cm
 B/B, Str.



04-432 16cm
04-433 20cm
04-434 22cm
 S/S, Str.



04-435 16cm
04-436 20cm
04-437 22cm
 S/S, Cvd.



04-438 16cm
04-439 20cm
04-440 22cm
 B/B, Cvd.



NOYES MICRO SCISSORS
 04-441 15cm
 S/S



NOYES MICRO SCISSORS
 04-442 14.5cm
 S/S



ESMARCH KNIFE
04-443 18cm



BRUNS SCISSORS



04-444
24 cm
Cvd, Probe End



04-445
24cm
Cvd, Serrated
Probe End



**LISTER-EXCENTRIC
PLASTER SCISSORS**

04-446 16 cm
04-447 19 cm
Angled, Probe End



Saw Edge Upper
Teeth is Serrated



LISTER BANDAGE PLASTER

Scissors, one large ring
04-448 9 cm
04-449 11 cm
04-450 14 cm
04-451 15 cm
04-452 18 cm
04-453 20 cm
Angled, Probe End



BERGMANN SCISSORS
04-454 23 cm
Angled, Probe End



ESMARCH SCISSORS
04-455 20 cm
04-456 23 cm
Angled, Probe End



**LISTER BANDAGE
PLASTER SCISSORS**
04-457 9 cm
04-458 11 cm
04-459 14 cm
04-460 15 cm
04-461 18 cm
04-462 20 cm
Angled, Probe End



PLASTER SCISSORS
04-463 17 cm
Angled



**BURNHAM BANDAGE
PLASTER SCISSORS**
04-464 14 cm
Angled



BANDAGE SCISSORS
04-465 16.0 cm



**SMITH (Mod. Usa)
PLASTER SCISSORS**
04-466 16 cm
04-467 18 cm
04-468 20 cm
04-469 23 cm



**LORENZ PLASTER
SCISSORS**
04-470 23 cm
B/B, Cvd



**LANGE BANDAGE
SCISSORS**
04-471 18.0 cm
B/B



**BRAUN-STADLER
PLASTER SCISSORS**
04-472 14cm
04-473 22cm
B/B, Angled



**BUSCH PLASTER
SCISSORS**
04-474 13 cm
04-475 16 cm
B/B, Cvd.



**KNOWLES PLASTER
SCISSORS**
04-476 14 cm
Str. Probe End



**KNOWLES PLASTER
SCISSORS**
04-477 14 cm
Angled, Probe End



**WALDMANN PLASTER
SCISSORS**
04-478 18 cm
Probe End

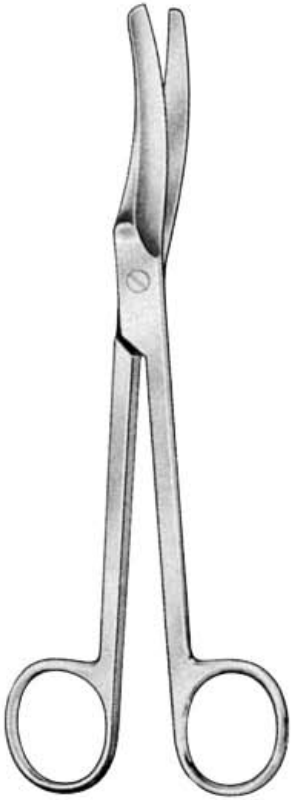

WALDMANN SCISSORS
04-479 18 cm



SCHUMACHER PLASTER SCISSORS
04-480 16 cm



MODIFIED-USA PLASTER SCISSORS
04-481 10.5 cm



MARBACH PLASTER SCISSORS
04-482 15.5 cm
Probe End, Serrated blade



SEUTIN PLASTER SCISSORS
04-483 20cm
Probe End



SEUTIN PLASTER SCISSORS
04-484 23cm
Probe End



Stille Plaster Shears
04-485 23 cm
04-486 26 cm
04-487 37 cm
04-488 Spare Blade



STILLE PLASTER SHEARS
04-489 24 cm
04-490 Spare Blade



**HENNIG PLASTER
CAST SPREADER**
04-491 28 cm



MODEL USA CAST SPREADER PLASTER
04-492 23 cm 3 Prong



SPREADER PLASTER
04-493 29 cm



With removable jaws



WOLFF SPREADER PLASTER
04-494 18 cm
04-495 24 cm



**Standard Operating
 Super Cut Scissors**



04-496
 14.5 cm
04-497
 16.5 cm
 Str. B/B



04-498
 14.5 cm
04-499
 16.5 cm
 Str. S/B



04-500
 14.5 cm
04-501
 16.5 cm
 Str. S/S



**Standard Operating
 Super Cut Scissors**



04-502
 14.5 cm
04-503
 16.5 cm
 Cvd. B/B



04-504
 14.5 cm
04-505
 16.5 cm
 Cvd. S/B



04-506
 14.5 cm
04-507
 16.5 cm
 Cvd. S/S



**Lexer Operating
 Super Cut Scissors**



04-508 16 cm
04-509 21 cm
 B/B, Str.



04-510 16.5 cm
04-511 21 cm
 B/B, Cvd.



**Safety Super
 Cut Scissors**
04-512 Str.
04-513 Cvd.
 9.0 cm, Probe
 Ends



**Goldman-fox Super
 Cut Scissors**
04-514 Str.
04-515 Cvd.
 9.0 cm, S/S



**Stevens Tenotomy
 Super Cut Scissors**
04-516 Str.
04-517 Cvd.
 9.0 cm, B/B



**Stevens Tenotomy
 Super Cut Scissors**
04-518 Str.
04-519 Cvd.
 11.5 cm, S/S

I N S T R U M E N T S



**BABY METZENBAUM
 SUPER CUT SCISSORS**
04-520 11.5 cm
 B/B, Str.



**BABY METZENBAUM
 SUPER CUT SCISSORS**
04-521 11.5 cm
 B/B, Cvd.



IRIS SUPER CUT SCISSORS
04-522 9.0 cm
04-523 11.5 cm
 S/S, Str.



IRIS SUPER CUT SCISSORS
04-524 9.0 cm
04-525 11.5 cm
 S/S, Cvd.

**Operating Scissors, S/S Str.
T/C Insert**

04-526	11.5 cm
04-527	13.0 cm
04-528	14.0 cm
04-529	15.0 cm
04-530	16.0 cm
04-531	17.5 cm
04-532	18.5 cm
04-533	20.0 cm

**Operating Scissors, S/S Cvd.
T/C Insert**

04-534	11.5 cm
04-535	13.0 cm
04-536	14.0 cm
04-537	15.0 cm
04-538	16.0 cm
04-539	17.5 cm
04-540	18.5 cm
04-541	20.0 cm

**Operating Scissors, B/B Str.
T/C Insert**

04-542	11.5 cm
04-543	13.0 cm
04-544	14.0 cm
04-545	15.0 cm
04-546	16.0 cm
04-547	17.5 cm
04-548	18.5 cm
04-549	20.0 cm

**Operating Scissors, B/B Cvd.
T/C Insert**

04-550	11.5 cm
04-551	13.0 cm
04-552	14.0 cm
04-553	15.0 cm
04-554	16.0 cm
04-555	17.5 cm
04-556	18.5 cm
04-557	20.0 cm

**Operating Scissors, S/B
Standard Str. T/C Insert**

04-558	11.5 cm
04-559	13.0 cm
04-560	14.0 cm
04-561	15.0 cm
04-562	16.0 cm
04-563	17.5 cm
04-564	18.5 cm
04-565	20.0 cm





**Operating Scissors, S/B
Standard Cvd. T/C Insert**

04-566	11.5 cm
04-567	13.0 cm
04-568	14.0 cm
04-569	15.0 cm
04-570	16.0 cm
04-571	17.5 cm
04-572	18.5 cm
04-573	20.0 cm

Metzenbaum Operating Scissors T/C Insert

		
04-574 11.5 cm 04-575 14.5 cm B/B Str.	04-576 11.5 cm 04-577 14.5 cm S/B Str.	04-578 11.5 cm 04-579 14.5 cm S/S Str.

Metzenbaum Operating Scissors T/C Insert

		
04-580 11.5 cm 04-581 14.5 cm B/B Cvd.	04-582 11.5 cm 04-583 14.5 cm S/B Cvd.	04-584 11.5 cm 04-585 14.5 cm S/S Cvd.

Metzenbaum-Fino Operating Scissors T/C Insert

	
04-586 14.5 cm 04-587 18 cm 04-588 20 cm 04-589 23 cm B/B Str.	04-590 14.5 cm 04-591 18 cm 04-592 20 cm 04-593 23 cm B/B Cvd.





Metzenbaum-Fino Operating Scissors T/C Insert

	
04-594 14.5 cm 04-595 18 cm 04-596 20 cm 04-597 23 cm S/S Str.	04-598 14.5 cm 04-599 18 cm 04-600 20 cm 04-601 23 cm S/S Cvd.

Metzenbaum-Nelson Operating Scissors T/C Insert

		
04-602 18 cm 04-603 20 cm 04-604 23 cm 04-605 25 cm 04-606 28 cm 04-607 30 cm B/B Str.	04-608 18 cm 04-609 20 cm 04-610 23 cm 04-611 25 cm 04-612 28 cm 04-613 30 cm S/B Str.	04-614 18 cm 04-615 20 cm 04-616 23 cm 04-617 25 cm 04-618 28 cm 04-619 30 cm S/S Str.

Metzenbaum-Nelson Operating Scissors T/C Insert

		
04-620 18 cm 04-621 20 cm 04-622 23 cm 04-623 25 cm 04-624 28 cm 04-625 30 cm B/B Cvd.	04-626 18 cm 04-627 20 cm 04-628 23 cm 04-629 25 cm 04-630 28 cm 04-631 30 cm S/B Cvd.	04-632 18 cm 04-633 20 cm 04-634 23 cm 04-635 25 cm 04-636 28 cm 04-637 30 cm S/S Cvd.



Mayo Dissecting & Gynecological Scissors T/C Insert



04-638 14.5 cm	04-642 14.5 cm
04-639 15.0 cm	04-643 15.0 cm
04-640 17.0 cm	04-644 17.0 cm
04-641 23.0 cm	04-645 23.0 cm
B/B, Str.	B/B, Cvd.



Mayo-stille Dissecting & Gynecological Scissors T/C Insert



04-646 15.0 cm	04-650 15.0 cm
04-647 17.0 cm	04-651 17.0 cm
04-648 19.5 cm	04-652 19.5 cm
04-649 21.0 cm	04-653 21.0 cm
B/B, Str.	B/B, Cvd.



ENT-DEAN SCISSORS
04-654 17 cm
 S/S Double Cvd.
 Serrated



KELLY OPERATING, DISSECTING SCISSORS



04-655 16.0 cm	04-657 16.0 cm
04-656 18.0 cm	04-658 18.0 cm
S/S Str.	S/S Cvd.



Goldmann-Fox Operating Scissors T/C Insert



04-659 13 cm	04-660 13 cm
S/S Str.	S/S Cvd.



WIRE CUTTING SCISSORS
04-661 12 cm

Chirurgische scheren
Tijeras quirúrgicas

Ciseaux chirurgicaux
Forbici per chirurgia



Lister Bandage Plaster Scissors T/C Insert, one large ring
04-662 8.9cm
04-663 11.43 cm
04-664 14 cm
04-665 16 cm
04-666 18 cm
04-667 20 cm



Lister Bandage Plaster Scissors, T/C Insert
04-668 8.9cm
04-669 11.43 cm
04-670 14 cm
04-671 16 cm
04-672 18 cm
04-673 20 cm



Castroviejo Scissors T/C Insert



04-674
14 cm
B/B Str.

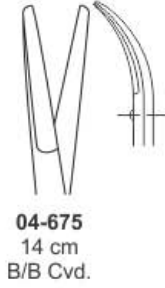

04-675
14 cm
B/B Cvd.



04-676
14 cm
S/B Str.



04-677
14 cm
S/B Cvd.



04-678
14 cm
S/S Str.

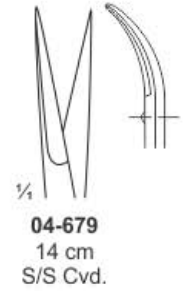

04-679
14 cm
S/S Cvd.



Joseph Operating Scissors T/C Insert



Reynolds Operating Scissors T/C Insert



Foman Operating Scissors T/C Insert
04-686
13 cm Full Bent



Stevens Operating Scissors T/C Insert



04-680
14 cm
S/S Str.



04-681
14 cm
S/S Cvd.



04-682
16 cm
S/S Str.



04-684
16 cm
S/S Cvd.



04-687
10 cm
Str.



04-689
10 cm
Cvd.

Universal Paramedic Shear

04-691 14cm (PINK)
 04-692 16cm (PINK)
 04-693 18cm (PINK)



04-709 14cm (ORANGE)
 04-710 16cm (ORANGE)
 04-711 18cm (ORANGE)



04-694 14cm (BLUE)
 04-695 16cm (BLUE)
 04-696 18cm (BLUE)



04-712 14cm (GREEN)
 04-713 16cm (GREEN)
 04-714 18cm (GREEN)



04-697 14cm (YELLOW)
 04-698 16cm (YELLOW)
 04-699 18cm (YELLOW)



04-715 14cm (WHITE)
 04-716 16cm (WHITE)
 04-717 18cm (WHITE)



04-700 14cm (Cyan)
 04-701 16cm (Cyan)
 04-702 18cm (Cyan)



04-718 14cm (RED)
 04-719 16cm (RED)
 04-720 18cm (RED)



04-703 14cm (BLACK)
 04-704 16cm (BLACK)
 04-705 18cm (BLACK)



04-721 14cm (ROYAL BLUE)
 04-722 16cm (ROYAL BLUE)
 04-723 18cm (ROYAL BLUE)



04-706 14cm (RED)
 04-707 16cm (RED)
 04-708 18cm (RED)



04-724 14cm (BLUE)
 04-725 16cm (BLUE)
 04-726 18cm (BLUE)

DRESSING & TISSUE FORCEPS





Standard Dressing Forceps
serrated

05-01	10.5cm
05-02	11.5cm
05-03	13cm
05-04	14.5cm
05-05	16cm
05-06	18cm
05-07	20cm
05-08	25cm
05-09	30cm



Standard Tissue Forceps
1x2 Teeth

05-10	10.5cm
05-11	11.5cm
05-12	13cm
05-13	14.5cm
05-14	16cm
05-15	18cm
05-16	20cm
05-17	25cm
05-18	30cm



Mod. USA, Dressing Forceps
serrated

05-19	10.2cm
05-20	12cm
05-21	13cm
05-22	14.5cm
05-23	15.5cm
05-24	18cm
05-25	21cm
05-26	25cm
05-27	31cm



Mod. USA, Tissue Forceps
1x2 teeth

05-28	10.2cm
05-29	11.4cm
05-30	12.7cm
05-31	14.0cm
05-32	15.2cm
05-33	17.8cm
05-34	20.3cm
05-35	25.4cm
05-36	30.5cm



Mod. Martin Dressing Forceps

05-37	12.7cm
05-38	14.0cm



Standard Dressing Forceps
Curved, serrated

05-39	11.4cm
05-40	12.7cm
05-41	14.0cm
05-42	15.2cm
05-43	17.8cm
05-44	20.3cm
05-45	25.4cm
05-46	30.5cm



Standard Dressing Forceps
wide pattern cross serration

05-47	11.4cm
05-48	12.7cm
05-49	14.0cm
05-50	15.20cm
05-51	17.8cm
05-52	20.3cm
05-53	25.4cm
05-54	30.5cm



Standard Dressing Forceps
Narrow Point serrated

05-55	12.7cm
05-56	14 cm
05-57	15.20cm
05-58	17.8cm
05-59	20.3cm
05-60	25.4cm
05-61	30.5cm



Semken Dressing Forceps
Straight Serrated

05-62	12.5cm
05-63	15.5cm



Semken Dressing Forceps
Curved Serrated

05-64	12.5cm
05-65	15.5cm



Potts-Smith Dressing Forceps
Straight Serrated

05-66	17.5cm
05-67	21cm
05-68	25 cm



Potts-Smith Dressing Forceps
Curved Serrated

05-69	17.5cm
05-70	21cm
05-71	25cm



Potts-Smith Tissue Forceps
1x2 teeth Straight
05-72 17.5cm
05-73 21.0cm
05-74 25.0cm



Potts-Smith Tissue Forceps
1x2 teeth Curved
05-75 17.5cm
05-76 21.0cm
05-77 25.0cm



Brophy Dressing Forceps
Straight Serrated
05-78 20cm



Brophy Dressing Forceps
Curved Serrated
05-79 20cm



Brophy Tissue Forceps
1x2 teeth
Straight Serrated
05-80 20cm



Brophy Tissue Forceps
1x2 teeth
Curved Serrated
05-81 20cm



Wangenstein Dressing Forceps
05-82 23cm



Stone Tissue Forceps
4X5 Teeth
05-83 15.2cm

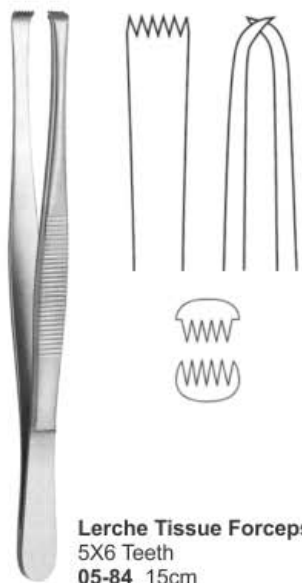

Lerche Tissue Forceps
5X6 Teeth
05-84 15cm

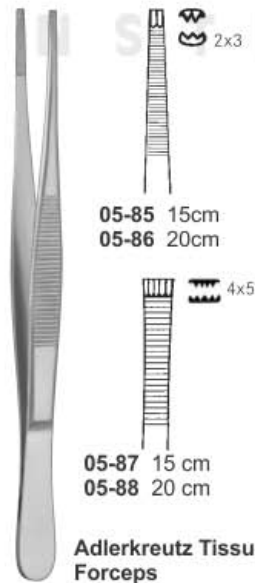

05-85 15cm
05-86 20cm

05-87 15 cm
05-88 20 cm

Adlerkreutz Tissue Forceps

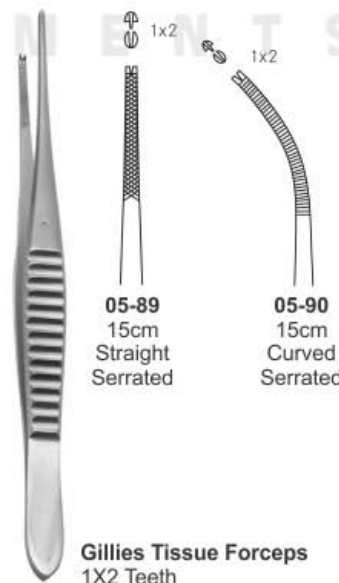

05-89
15cm
Straight
Serrated

05-90
15cm
Curved
Serrated

Gillies Tissue Forceps
1X2 Teeth



Treves Tissue Forceps
1x2 Teeth
05-91 12.5cm
05-92 15cm
05-93 18cm
Dissecting Forceps
teeth, on smooth jaws.



Tissue Forceps
2x3 Teeth
05-94 11.4cm
05-95 13.0cm
05-96 14.5cm
05-97 16.0cm
05-98 17.5cm
05-99 20.0cm
05-100 25.0cm
05-101 30.0cm



Tissue Forceps
3x4 Teeth
05-102 11.4cm
05-103 13.0cm
05-104 14.5cm
05-105 16.0cm
05-106 17.5cm
05-107 20.0cm
05-108 25.0cm
05-109 30.0cm



Tissue Forceps
4x5 Teeth
05-110 11.4cm
05-111 13.0cm
05-112 14.5cm
05-113 16.0cm
05-114 17.5cm
05-115 20.0cm
05-116 25.0cm
05-117 30.0cm



Iris Tissue Forceps
1x2 Teeth, Straight
05-118 10.2 cm



Iris Tissue Forceps
1x2 Teeth, Half Curved
05-119 10.2 cm



Iris Tissue Forceps
1x2 Teeth, Full Curved
05-120 10.2 cm



Iris Forceps
05-121
10cm



Iris Tissue Forceps
1x2 teeth
05-122 10cm



Waugh Dressing Forceps
05-123 15 cm
05-124 18 cm
slightly heavier
non-toothed,
serrated jaws.



Waugh Tissue Forceps
1x2 Teeth
05-125 15 cm
05-126 18 cm
as above but one two
tooth on serrated jaws.
Known as Scott.



Leedham Tissue Forceps
1x2 Teeth
05-127 14.5 cm
05-128 18 cm
Green Dissecting
Forceps two three
teeth, smooth jaws.



Charnley Tissue Forceps
1x2 Teeth
05-129 14.5cm
05-130 18.0cm
Dissecting Forceps
one into two teeth,
block on jaws.



Ramsay Dissecting Forceps
05-131 18cm
 serrated jaws.



Ramsay Tissue Forceps
 Dissecting Forceps
 one into teeth on
 serrated jaws.



05-132
 18cm
 1x2 teeth



05-133
 18cm
 2x3 teeth



Dissecting Dressing Forceps
05-134 12.5cm
05-135 15.0cm
05-136 18.0cm
 turn over end,
 serrated jaws.



Dissecting Dressing Forceps
05-137 12.5cm
05-138 15.0cm
05-139 18.0cm
05-140 20.0cm
 block end, serrated
 jaws.



Ferris-Smith Tissue Forceps
05-141 18cm
 1x2 Teeth



Ferris-Smith Tissue Forceps
05-142 18cm
 2x3 Teeth



Lane Tissue Forceps
 1x2 Teeth
05-143 12.5cm
05-144 15cm
05-145 17cm
05-146 18cm
05-147 20cm



Lane Tissue Forceps
 2x3 Teeth
05-148 12.5cm
05-149 15cm
05-150 17cm
05-151 18cm
05-152 20cm



Bonney Tissue Forceps
05-153 18cm
 1x2 Teeth

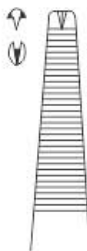

Bonney Tissue Forceps
05-154 18cm
 2x3 Teeth

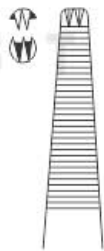

Durante Tissue Grasping Forceps
05-155 14.5cm
05-156 16cm
05-157 20cm



Nelson Tissue Forceps
05-158 23cm
 6x7 Teeth



Pinzas para tejidos, Pincas à dissection
Pinze per tessuti, Pinze per dissezione

Pincas a tissu, Anatomische pinzetten
Gewebe, Pinzas de disección



Russian-Modell Tissue Forceps
05-159 15cm
05-160 20cm
05-161 25cm



Singley-Tuttle Forceps
05-162 23cm

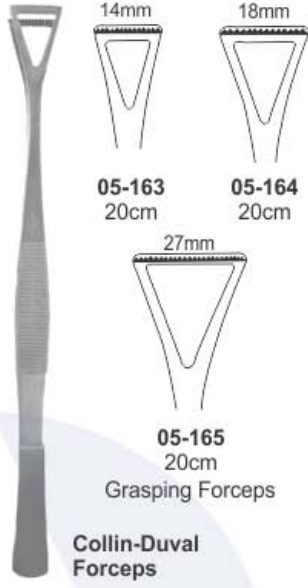

Collin-Duval Forceps

14mm 05-163 20cm
18mm 05-164 20cm
27mm 05-165 20cm
Grasping Forceps

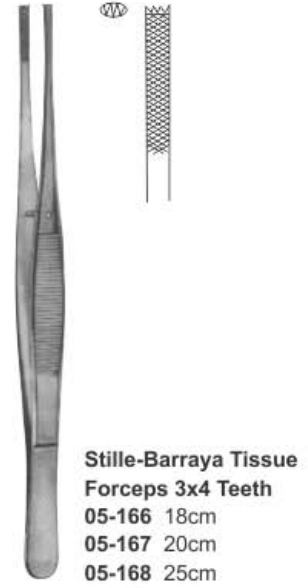

Stille-Barraya Tissue Forceps 3x4 Teeth
05-166 18cm
05-167 20cm
05-168 25cm



Duehrssen Dressing Forceps
Serrated
05-169 20cm



Duehrssen Tissue Forceps
1x2 Teeth
05-170 20cm



Duehrssen Tissue Forceps
2x3 Teeth
05-171 20cm



05-172
150mm
1x2 teeth

MC INDOE



Ochsner
05-173
145mm

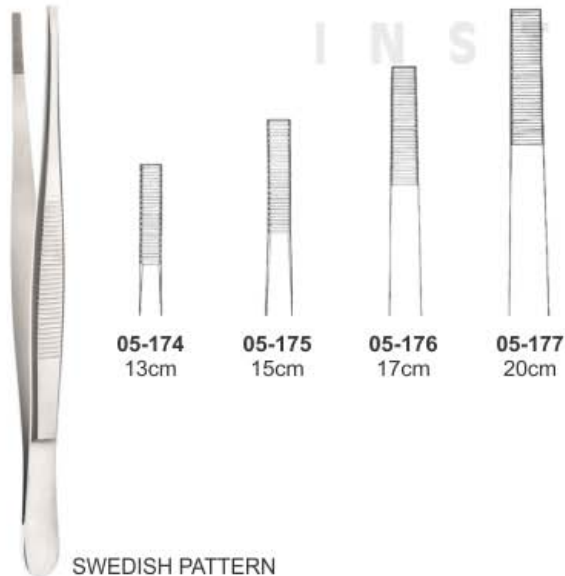

05-174 13cm
05-175 15cm
05-176 17cm
05-177 20cm

SWEDISH PATTERN

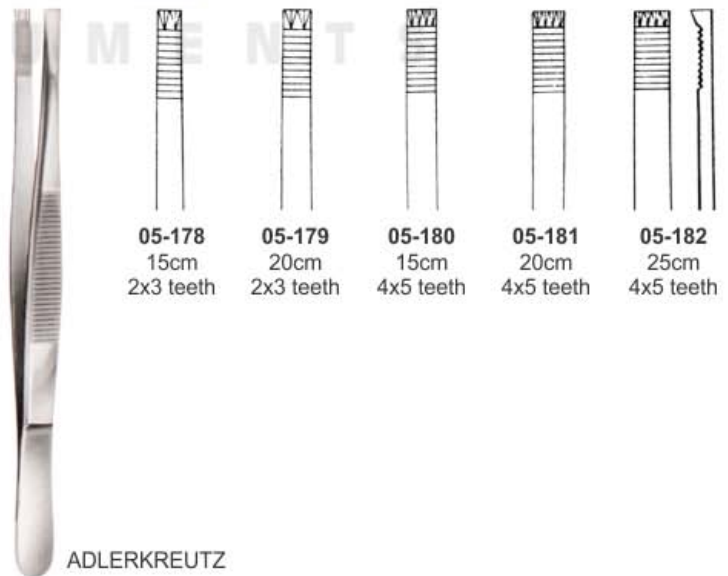

05-178 15cm 2x3 teeth
05-179 20cm 2x3 teeth
05-180 15cm 4x5 teeth
05-181 20cm 4x5 teeth
05-182 25cm 4x5 teeth

ADLERKREUTZ

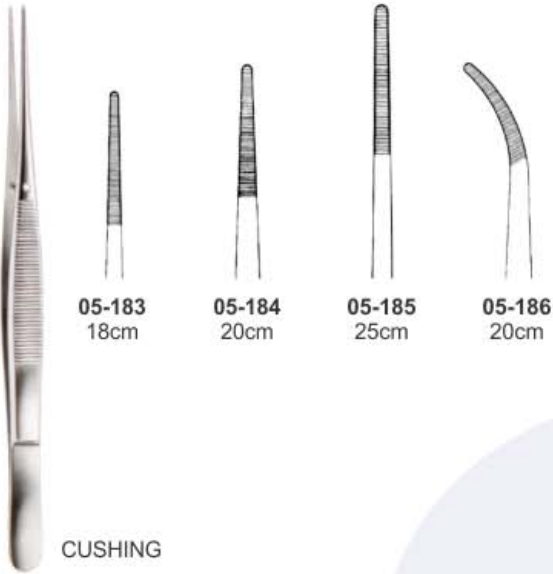

CUSHING



CAIRNS-DOTT

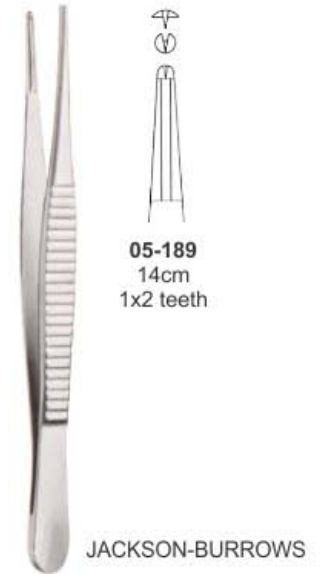

JACKSON-BURROWS



GERALD
1x2 teeth



GERALD
05-192
17.5cm
1x2 teeth



GERARD

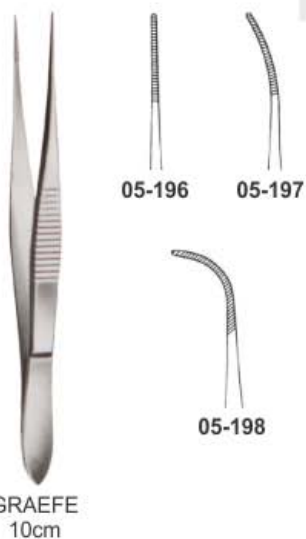

GRAEFE
10cm

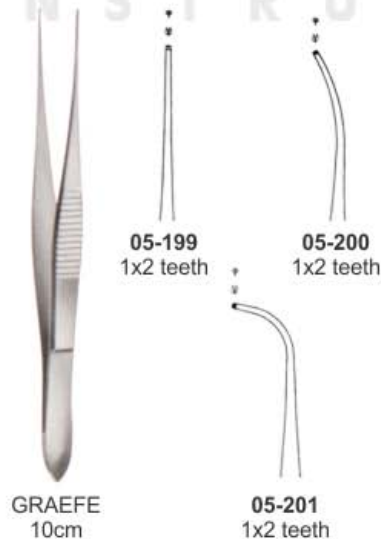

GRAEFE
10cm

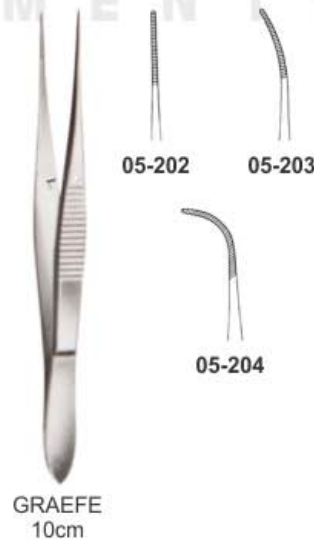

GRAEFE
10cm

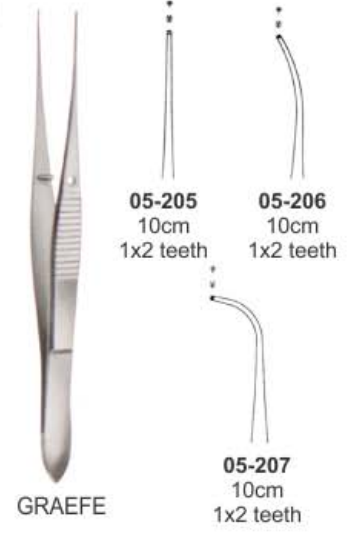

GRAEFE

05-207
10cm
1x2 teeth

Pinzas para tejidos, Pincas à dissection
Pinze per tessuti, Pinze per dissezione

Pincas a tissu, Anatomische pinzetten
Gewebe, Pinzas de disección



05-208
14cm
05-209
16cm
05-210
20cm
Dressing,
Serrated

**LUCAE / ENT
Dressing Forceps**



**Paper Dressing
Forceps
05-211 15cm**

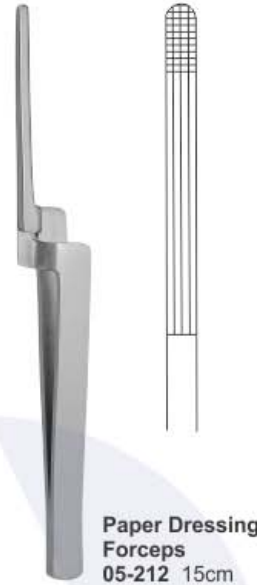

**Paper Dressing
Forceps
05-212 15cm**



**Paper Dressing
Forceps
05-213 15cm
Curved**

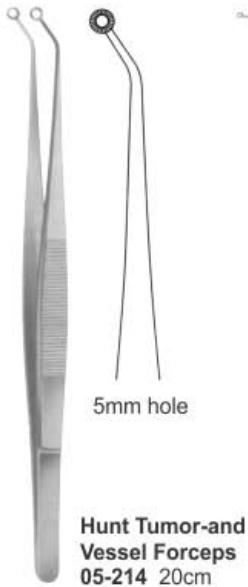

5mm hole

**Hunt Tumor-and
Vessel Forceps
05-214 20cm**



3 mm 4 mm 5 mm
05-215 24cm 3mm hole
05-216 24cm 4mm hole
05-217 24cm 5mm hole

**Samii Forceps
Spoon-Shaped Jaws Left
24cm**

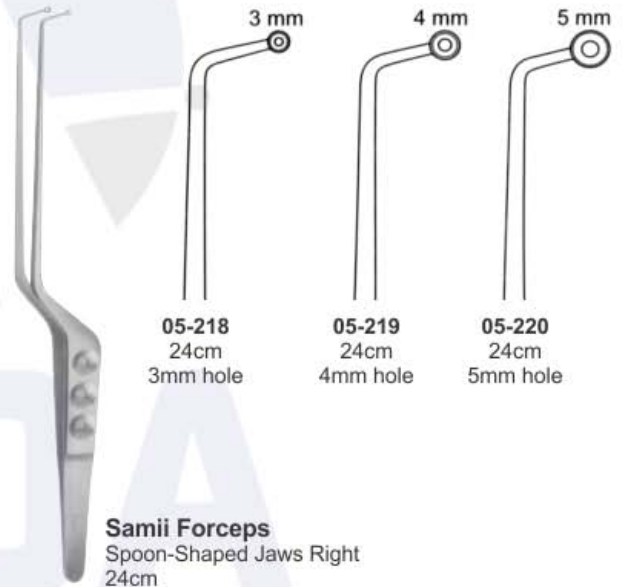

3 mm 4 mm 5 mm
05-218 24cm 3mm hole
05-219 24cm 4mm hole
05-220 24cm 5mm hole

**Samii Forceps
Spoon-Shaped Jaws Right
24cm**



**Micro Tying Forceps
05-221 15.5cm**



Lucae

05-222
14cm
05-223
16cm
05-224
18cm
05-225
20cm
Dressing
Serrated



Lucae

1x2 teeth
05-226
14cm
05-227
16cm
05-228
18cm
05-229
20cm



**Adson Bayonet
Dressing Forceps
05-230 21 cm
serrated**



Yasargil
05-231
20cm



Hunt
05-232
20cm



Hunt
05-233
20cm



Plain Forceps
05-234 18.5cm



Jansen
05-235 16 cm
05-236 18 cm
05-237 20 cm



Plain Forceps
05-238 16cm



Tissue Forceps
05-239 16cm



Gruenwald Forceps
05-240 14cm
05-241 20cm



Gruenwald Tissue Forceps
05-242 20cm



Hoen
05-243
20cm



D'Errico
05-244
22cm



D'Errico
05-245
22cm

Pinzas para tejidos, Pincas à dissection
Pinze per tessuti, Pinze per dissezione

Pincas a tissu, Anatomische pinzetten
Gewebe, Pinzas de disección



Adson
05-246
23cm



Troeltsch
05-247 10cm
05-248 12cm
05-249 15cm
05-250 17cm



Troeltsch
05-251
13cm



Wilde
05-252
11cm



Troeltsch
05-253
11.5cm



Landolt
05-254
21.5cm



Yasargil

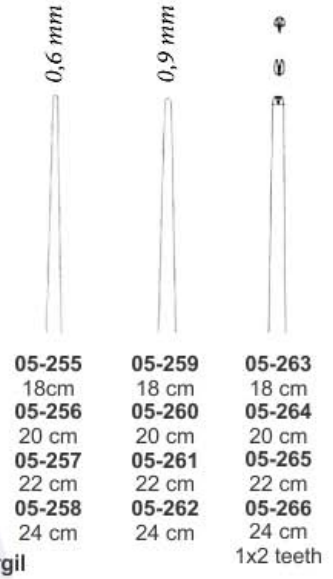

05-255 18cm	05-259 18 cm	05-263 18 cm
05-256 20 cm	05-260 20 cm	05-264 20 cm
05-257 22 cm	05-261 22 cm	05-265 22 cm
05-258 24 cm	05-262 24 cm	05-266 24 cm
		1x2 teeth



YASARGIL
22 cm



05-267



05-268



YASARGIL
22 cm



05-269



05-270



YASARGIL
24 cm



05-271



05-272



05-273

Pincas a tissu, Anatomische pinzetten
Gewebe, Pinzas de disección

Pinzas para tejidos, Pincas à dissection
Pinze per tessuti, Pinze per dissezione

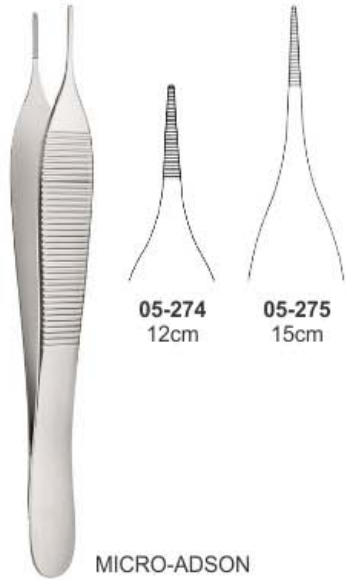

*Pincas a tissu, Anatomische pinzetten
Gewebe, Pinzas de disección*

*Pinzas para tejidos, Pincas à dissection
Pinze per tessuti, Pinze per dissezione*



05-287
12cm
1x2 teeth

ADSON



05-288
15cm
1x2 teeth

ADSON



05-289
12cm
1x2 teeth

ADSON



05-290
12cm
1x2 teeth

ADSON



05-291
12cm
1x2 teeth

ADSON



05-292
regular point straight
05-293
fine point straight
05-294
micro point straight
12 cm, 1x2 Teeth

Adson Tissue Forceps
Cuter Print



05-295
regular point with platform straight
05-296
fine point with platform straight
05-297
micro point with platform straight
12 cm, 1x2 Teeth



05-298
regular point curved
05-299
fine point curved
05-300
micro point curved
12 cm, 1x2 Teeth



05-301
regular point straight
05-302
fine point straight
05-303
micro point straight
12 cm, 1x2 Teeth



05-304 regular point, straight
05-305 fine point, straight
Forceps, 12cm 9x9 teeth

Adson Brown Tissue



05-306 regular point, Curved
05-307 fine point, Curved
Forceps, 12cm 9x9 teeth



05-308
regular point straight
05-309
fine point straight
05-310
micro point straight
12 cm, 1x2 Teeth

Adson Tissue Forceps
with fenestrated handle



05-311
regular point with platform
05-312
fine point with platform
05-313
micro point with platform
straight 12 cm, 1x2 Teeth



05-314
regular point
05-315
fine point
05-316
micro point
curved 12 cm,
1x2 Teeth



05-317
regular point
05-318
fine point
05-319
micro point
curved
12 cm, 1x2 Teeth



05-320 regular point, straight
05-321 fine point, straight
12cm 7x7 teeth

**Adson Brown
Tissue Forceps**
Fenestrated Handle



05-322 regular point, Curved
05-323 fine point, Curved
12cm 7x7 teeth

Graefe Forceps

05-324
7cm
05-325
10cm
straight
serrated



05-326
7cm
05-327
10cm
half curved
serrated



05-328
7cm
05-329
10cm
full curved
serrated



05-330
7cm
05-331
10cm
1x2 teeth
straight



05-332
7cm
05-333
10cm
1x2 teeth
half curved



05-334
7cm
05-335
10cm
1x2 teeth
full curved

Stevens Tissue Forceps
1x2 Teeth

05-336
11cm
straight

Stevens Tissue Forceps
1x2 Teeth

05-337
11cm
Curved

Graefe Dressing Forceps
05-338 0.5 mm
05-339 0.7 mm
05-340 1.0 mm
7cm
Straight Serrated

Graefe Dressing Forceps
05-341 0.5 mm
05-342 0.7 mm
05-343 1.0 mm
7cm
curved serrated

Graefe Tissue Forceps
1x2 Teeth
05-344 0.5 mm
05-345 0.7 mm
05-346 1.0 mm
7cm Straight

Graefe Tissue Forceps
1x2 Teeth
05-347 0.5 mm
05-348 0.7 mm
05-349 1.0 mm
7cm Curved

Graefe Fixation Forceps
05-350 11.2 cm
standard jaws 4.5mm wide
with fine teeth

05-351
90mm
05-352
105mm
05-353
115mm
05-354
125mm

Chirurgische pinzetten, Uhrmacher-Pinzetten
Pinzas de disección con dientes, Pinzas de relojero

Pinces à dissection à groffes, Pinces d'horloger
Pinze per dissezione con denti, Pinze de orologiaio



Dumont Forceps
05-355 11.5cm
 curved



05-356
 10.5cm
 full curved



05-357
 10.5cm
 half curved



05-358
 11cm



05-359
 11cm
 fine point



05-360
 11cm
 extra fine
 point

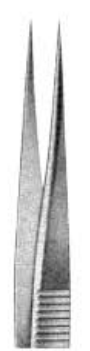

05-361
 12cm
 fine point



05-362
 12cm
 extra fine
 point



05-363
 12cm



Dumont Forceps
05-364
 style 1, fine point,
 12cm



Dumont Forceps
05-365
 style 2, strong
 fine point,
 12cm



Dumont Forceps
05-366
 style 3, narrow
 fine point,
 12cm



Dumont Forceps
05-367
 style 3C, narrow
 fine point,
 11cm



Dumont Forceps
05-368
 style 4, fine point,
 11cm



Dumont Forceps
05-369
 style 5, super fine
 11cm point



Dumont Forceps
05-370
 style 5, micro fine
 11cm point



Dumont Forceps
05-371
 style 7, micro fine
 11.5 cm curved



Dumont Forceps
05-372
 style 7, fine curved,
 11.5 cm



Dumont Forceps
05-373
 style 6, pick up,
 11.5 cm



Ziegler Cilia Forceps
05-374 9cm



Beer Cilia Forceps
05-375 9cm



Douglas Cilia Forceps
05-376 9cm



Gradle Cilia Forceps
05-377 10.5cm



Kuehne Cilia Forceps
05-378 10.5cm



Kuehne Cilia Forceps
05-379 10.5cm
angled sideways



Barraquer Cilia Forceps
05-380 10.5cm



Littauer Cilia Forceps
05-381 8.5cm



Littauer Cilia Forceps
05-382 9cm



Splinter Forceps
05-383 8 cm
05-384 9 cm
05-385 10.5cm
05-386 11.5cm
05-387 12.5cm
05-388 14.5cm
Straight Plain



Splinter Forceps
05-389 8cm
05-390 9cm
05-391 10.5cm
05-392 11.5cm
05-393 12.5cm
05-394 14.5cm
Curved Plain



Splinter Forceps
05-395 8cm
05-396 9cm
05-397 10.5cm
05-398 11.5cm
05-399 12.5cm
05-400 14.5cm
Straight serrated



Splinter Forceps
05-401 8cm
05-402 9cm
05-403 10.5cm
05-404 11.5cm
05-405 12.5cm
05-406 14.5cm
Curved serrated



Feilchenfeld Forceps
05-407 7.5cm
05-408 9cm
05-409 11cm
Straight

Splitterpinzetten
Pinzas Para espinas

Pinces à échardes
Pinze per scheggie



05-410
10.5cm
Straight

Hunter Forceps



05-411
10.5cm
Curved

Hunter Forceps



05-412
10.5cm
Straight

Carmalt Forceps



05-413
10.5cm
Curved

Carmalt Forceps



Splinter Forceps
05-414 8cm
05-415 9cm
05-416 10.5cm
05-417 11.5cm
05-418 12.5cm
05-419 14.5cm
Straight serrated
with guide pin



Splinter Forceps
05-420 8cm
05-421 9cm
05-422 10.5cm
05-423 11.5cm
05-424 12.5cm
05-425 14.5cm
Curved serrated with
guide pin



Splinter Forceps
05-426 8cm
05-427 9cm
05-428 10.5cm
05-429 11.5cm
05-430 12.5cm
05-431 14.5cm
Straight plain with
guide pin



Splinter Forceps
05-432 8cm
05-433 9cm
05-434 10.5cm
05-435 11.5cm
05-436 12.5cm
05-437 14.5cm
Curved plain with
guide pin



**Stieglitz Forceps
with Magnifying
Mirrors**
05-438 12.5cm



Ochsner Forceps
05-439 14cm



**Lange Tissue
Forceps**
05-440 10cm



**Childe Tissue
Forceps**
05-441 18cm



**Michel Tissue
Forceps**
05-442 12cm



**Wachenfeldt
Tissue Forceps**
05-443 12.5cm



**Hegenbarth
Tissue Forceps**
05-444 12.5cm

Splitterpinzetten
Pinzas Para espinas

Pinces à échardes
Pinze per scheggie



**Wachenfeldt
Tissue Forceps**
05-445 12.5cm

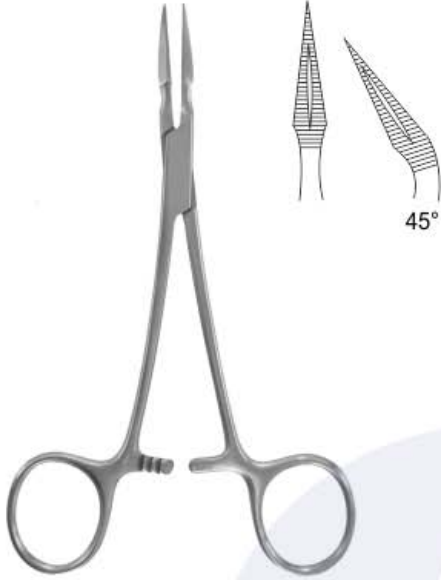

Stieglitz Splinter Forceps
05-446 14cm Str.
05-447 14cm 45° Angled



Stieglitz Splinter Forceps
05-448 14cm, 90° Angled



Peet Splinter Forceps
05-449 11.5cm

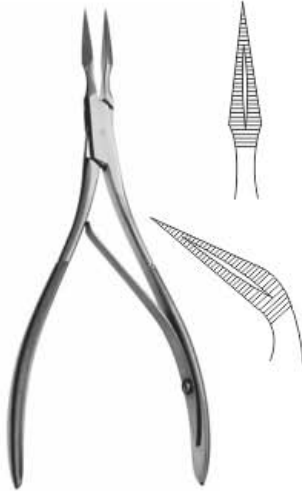

Ralk Splinter Forceps
05-450 15cm, Str.
05-451 15cm, Cvd.



Michel Clips
05-453
sizes; 11mm x 3mm
& 18mm x 3mm.

Michel Forceps
05-452 12cm



Mod. Michel Forceps
05-454 12cm



Collin Forceps
05-455 13cm



Richter-Heath Forceps
05-456 14cm



1,5 mm

05-457
14cm

3,0 mm

05-460
20cm

T.C Oehler Tissue Forceps



2,0 mm

05-458
16cm

3,7 mm

05-461
25cm



2,7 mm

05-459
18cm

4,0 mm

05-462
30cm



0,4 mm

05-463
15cm

**Semken
with dissector
end**



0,2 mm

05-464
16cm

0,2 mm

05-465
18cm

**Semken
1x2 teeth**



1,5 mm

2,0 mm

**T.C De Bakey
Dressing Forceps**
05-466 15cm
05-467 19cm
05-468 24cm



0,4 mm

**T.C Gillies
Tissue Forceps**
05-469 15cm

*Pinces a tissu, Anatomische pinzetten
Gewebe, Pinzas de disección*

*Pinzas para tejidos, Pinces à dissection
Pinze per tessuti, Pinze per dissezione*

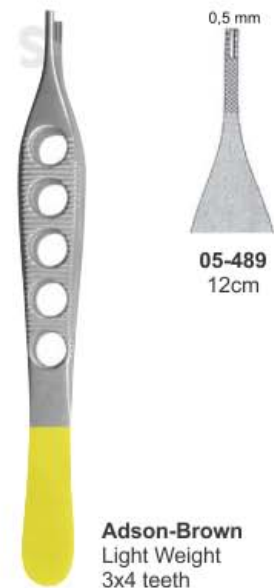
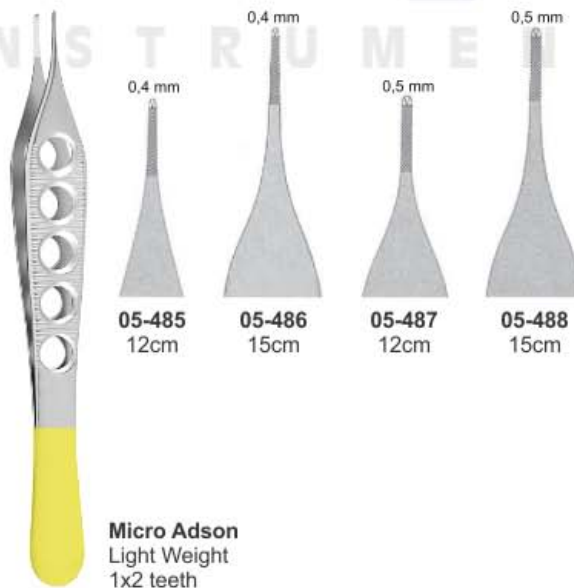
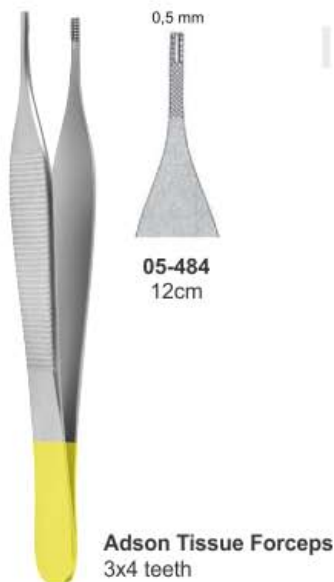
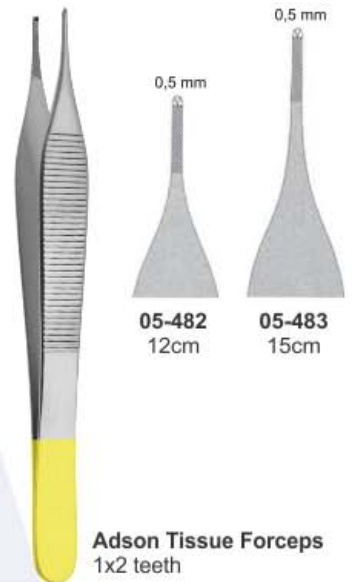
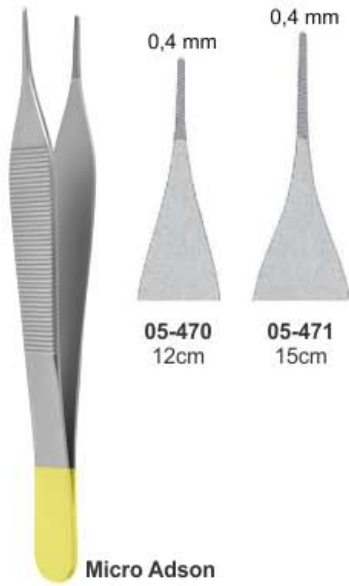

Pincas a tissu, Anatomische pinzetten
Gewebe, Pinzas de disección

Pinzas para tejidos, Pincas à dissection
Pinze per tessuti, Pinze per dissezione

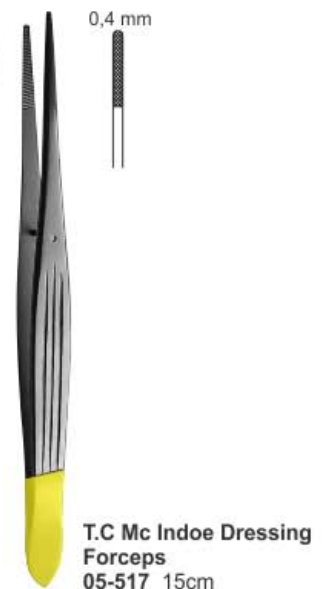
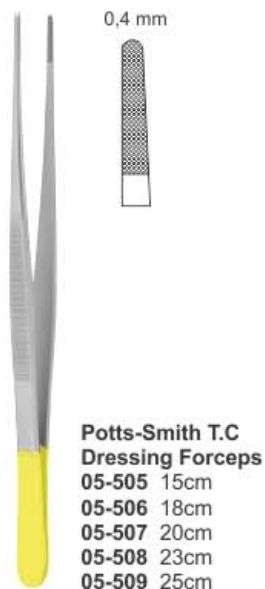
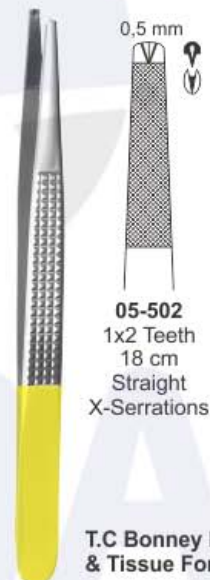
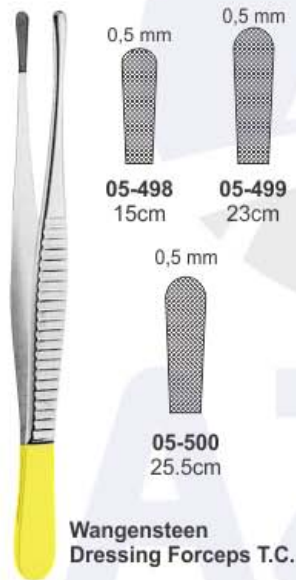
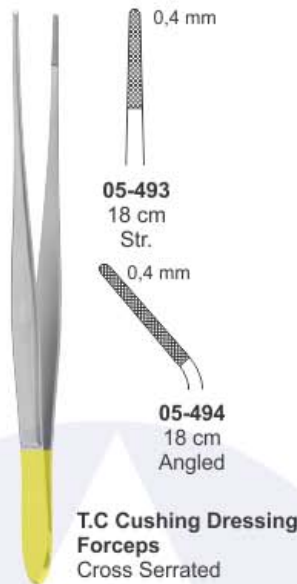
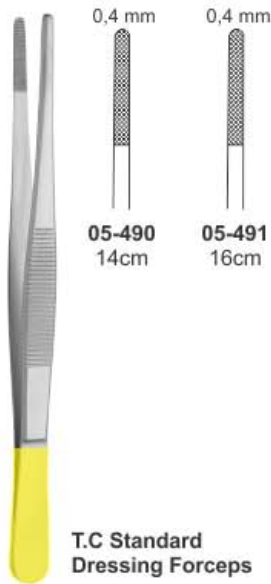

HAEMOSTATIC FORCEPS



Arterienklemmen

Pinzas Hemostaticas

Pinces Hemostatiques

Pinze Emostatiche

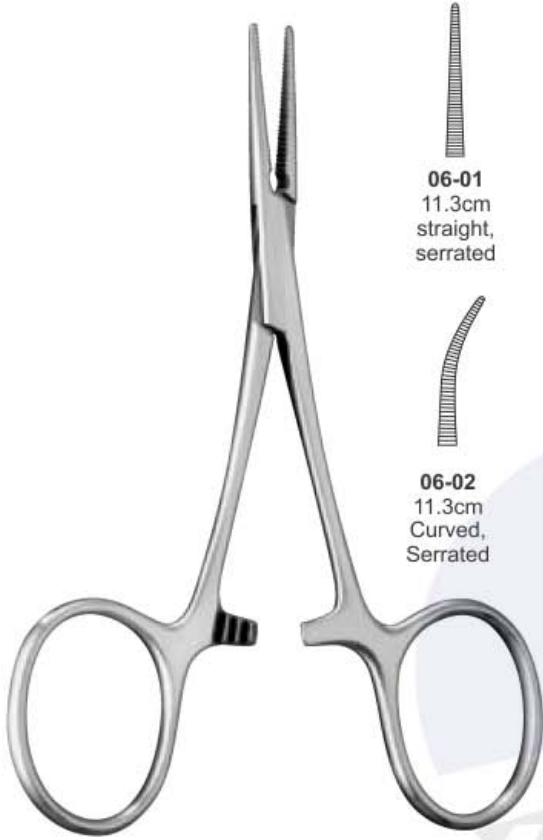

Mosquito Haemostatic Forceps



06-01
11.3cm
straight,
serrated

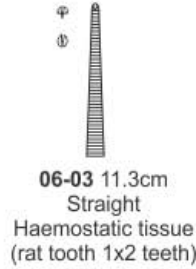

06-03 11.3cm
Straight
Haemostatic tissue
(rat tooth 1x2 teeth)



06-02
11.3cm
Curved,
Serrated



06-04 11.3cm
Curved
Haemostatic tissue
(rat tooth 1x2 teeth)



Halsted-Mosquito Haemostatic Forceps



06-05
12.5cm
06-06
20cm
straight



06-07
12.5cm
06-08
20cm
curved



Halsted-Mosquito Haemostatic Forceps



06-09
12.5cm
06-10
20cm
straight
Left Handed



06-11
12.5cm
06-12
20cm
curved
Left Handed



Kelly Haemostatic Forceps



06-13
14cm
straight



06-15
Kelly Haemostatic Fine
point Forceps 14cm
straight

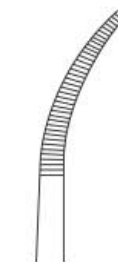

06-14
14cm
curved



06-16
Kelly Haemostatic Fine
point Forceps 14cm
curved

Arterienklemmen
Pinces Hemostatiques

Pinzas Hemostaticas
Pinze Emostatiche

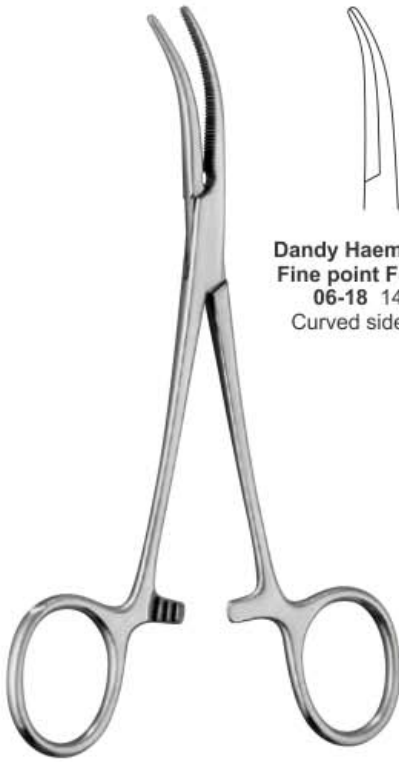

Dandy Haemostatic Fine point Forceps
06-18 14cm
Curved sideways

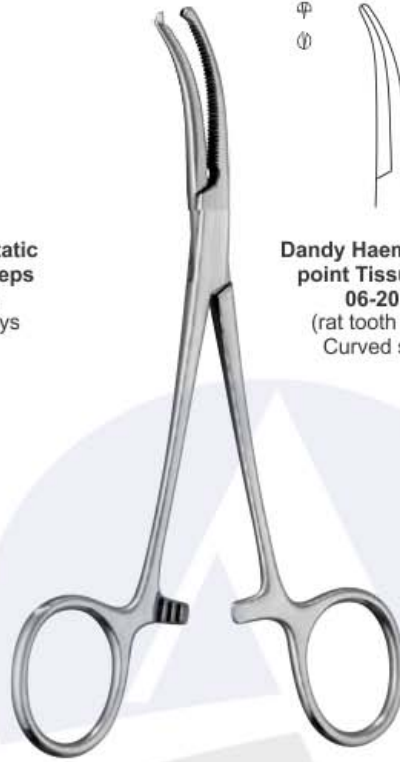

Dandy Haemostatic Fine point Tissue Forceps
06-20 14cm
(rat tooth 1x2 teeth)
Curved sideways

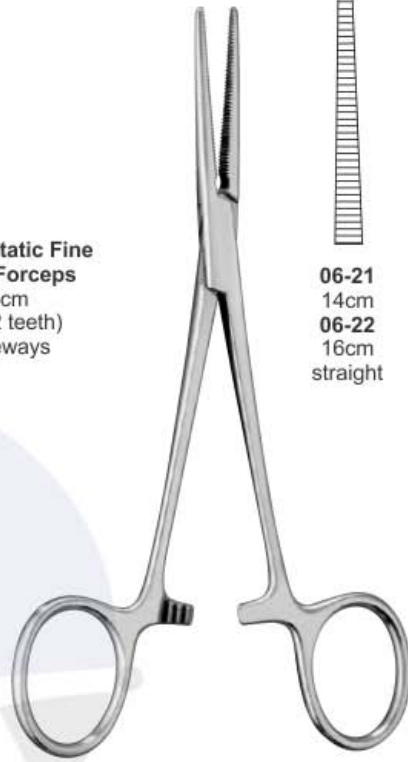

06-21
14cm
06-22
16cm
straight

06-23
14cm
06-24
16cm
curved

Dandy Haemostatic Forceps
06-17 14cm
Curved sideways

Dandy Haemostatic Tissue Forceps
06-19 14cm
(rat tooth 1x2 teeth)
Curved sideways

Crile Haemostatic Forceps

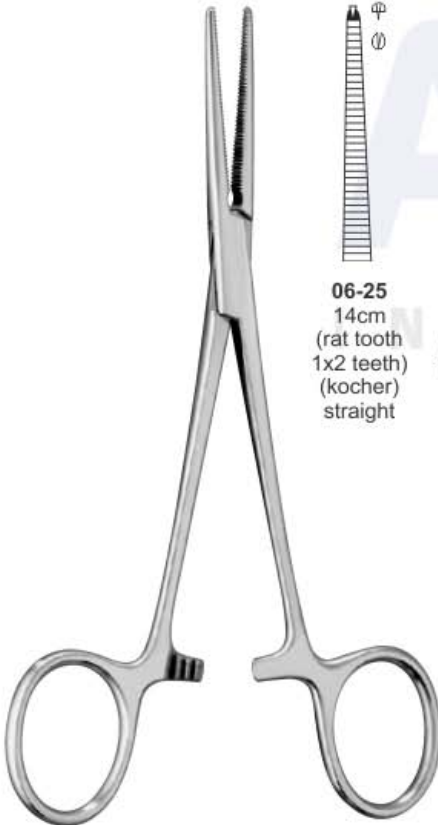

Crile Haemostatic Tissue Forceps

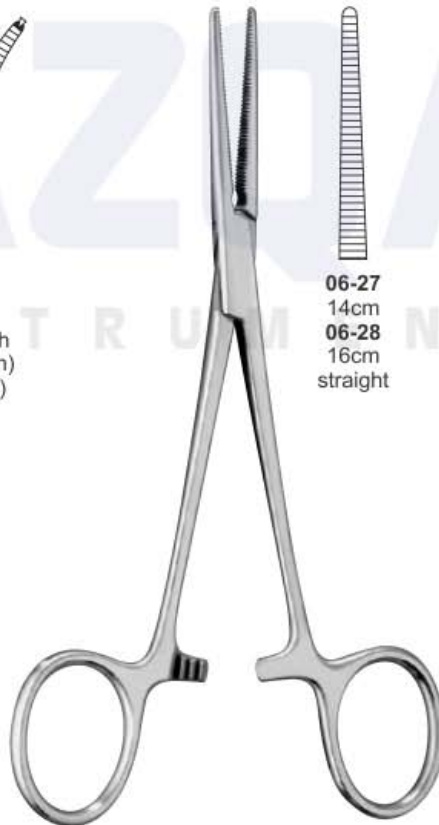

Crile Haemostatic Fine Point Forceps

06-25
14cm
(rat tooth 1x2 teeth)
(kocher)
straight

06-26
14cm
(rat tooth 1x2 teeth)
(kocher)
curved

06-27
14cm
06-28
16cm
straight

06-29
14cm
06-30
16cm
curved

06-31
14cm
straight
(rat tooth 1x2 teeth)
Crile Haemostatic Fine Point Tissue Forceps

06-32
14cm
curved
(rat tooth 1x2 teeth)
Crile Haemostatic Fine Point Tissue Forceps

Arterienklemmen
Pinces Hemostatiques

Pinzas Hemostaticas
Pinze Emostatiche

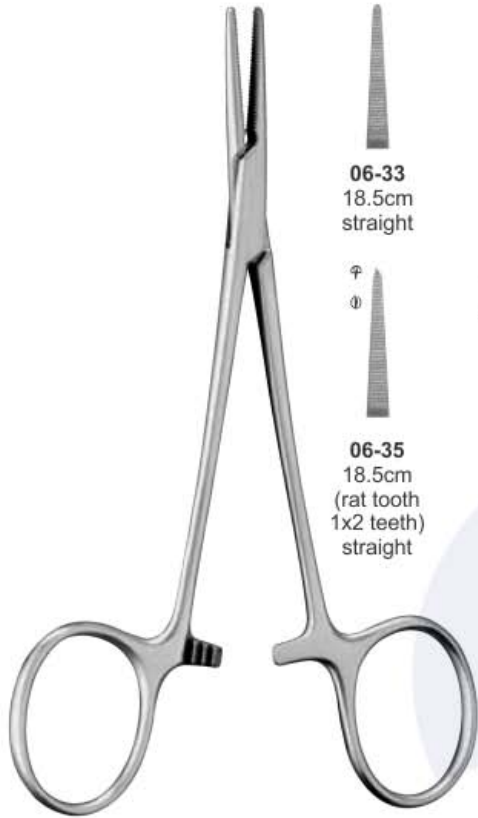

06-33
18.5cm
straight

06-34
18.5cm
curved



06-35
18.5cm
(rat tooth
1x2 teeth)
straight



06-36
18.5cm
(rat tooth
1x2 teeth)
curved

Halsted Haemostatic Forceps

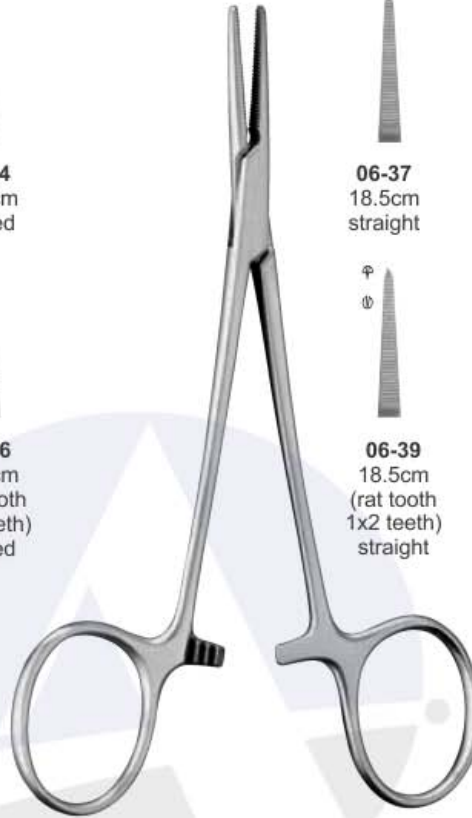

06-37
18.5cm
straight

06-38
18.5cm
curved



06-39
18.5cm
(rat tooth
1x2 teeth)
straight



06-40
18.5cm
(rat tooth
1x2 teeth)
curved

Halsted Haemostatic
Fine point Forceps

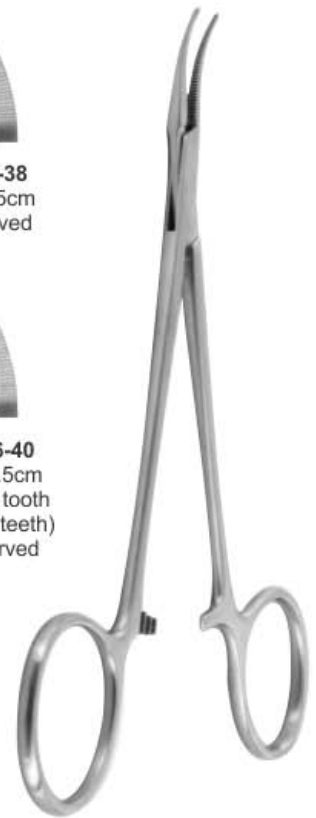

Packer Mosquito Forceps
06-41 12.7cm
Curved, flat jaws



06-42
14cm
06-43
16cm
Straight,
serrated

06-44
14cm
06-45
16cm
Curved,
serrated

Coller Haemostatic Forceps



06-46
13cm
06-47
15cm
Curved,
Serrated

Christophe Haemostatic Forceps



06-48
24cm
Straight,
Serrated

06-49
24cm
Curved
Serrated

Saroot Haemostatic
Forceps

Arterienklemmen
Pinces Hemostatiques

Pinzas Hemostaticas
Pinze Emostatiche



06-50
18.5cm
straight

06-51
18.5cm
curved

Adson Haemostatic Fine point Forceps



06-52
18.5cm
straight
(rat tooth
1x2 teeth)

06-53
18.5cm
Curved
(rat tooth
1x2 teeth)

Adson Haemostatic Tissue Forceps



06-54
15cm
06-55
20cm
Curved

06-56
15cm
06-57
20cm
Curved
Fine Point

O'Shaughnessy Haemostatic Forceps

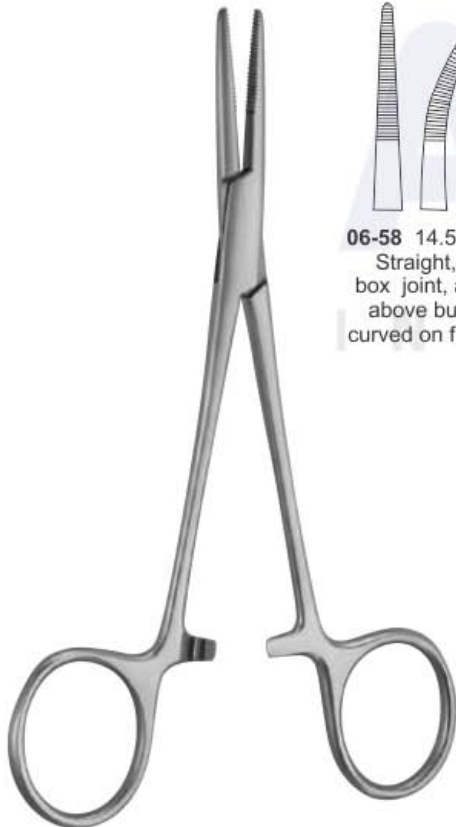

06-58 14.5cm
Straight,
box joint, as
above but
curved on flat.

Cairns Haemostatic Forceps



06-59
13cm
06-60
14cm
straight

06-61
13cm
06-62
14cm
curved

Pean Haemostatic Forceps Slender Type



06-63
14.5cm
Straight

Kocher Haemostatic Forceps Strong Pattern

Arterienklemmen
Pincas Hemostatiques

Pinzas Hemostaticas
Pinze Emostatiche

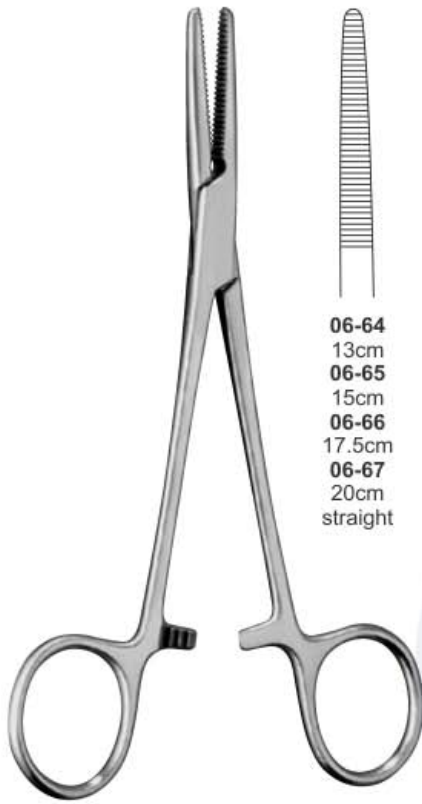

- | | |
|----------------------------------|--------------------------------|
| 06-64
13cm | 06-68
13cm |
| 06-65
15cm | 06-69
15cm |
| 06-66
17.5cm | 06-70
17.5cm |
| 06-67
20cm
straight | 06-71
20cm
curved |

**Spencer-Wells Haemostatic Forceps
Slender Type**

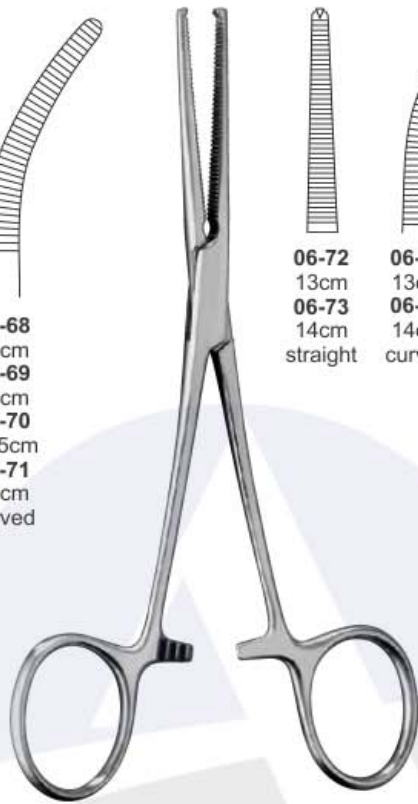

- | | |
|----------------------------------|--|
| 06-72
13cm
straight | 06-74
13cm
06-75
14cm
curved |
|----------------------------------|--|

**Kocher Haemostatic Forceps
1x2 teeth**



- | | |
|----------------------------------|--------------------------------|
| 06-76
16cm | 06-78
16cm |
| 06-77
20cm
Straight | 06-79
20cm
Curved |

**Rochester-Carmalt Haemostatic
Forceps**

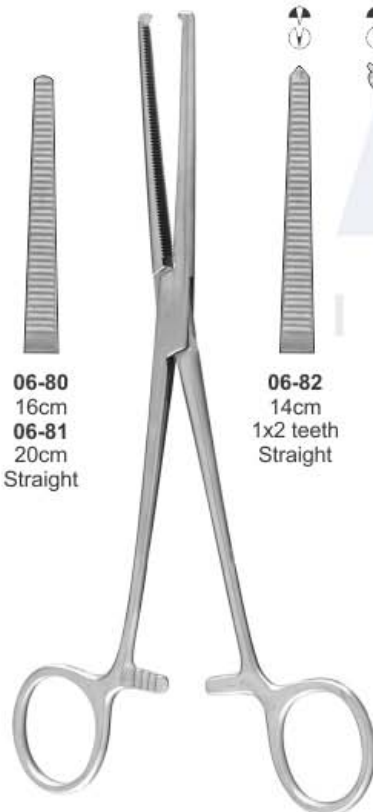

- | |
|----------------------------------|
| 06-80
16cm |
| 06-81
20cm
Straight |

**Rochester-Ochsner
Haemostatic Forceps**

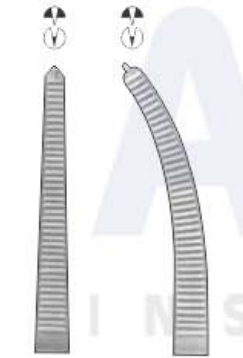

- | | |
|---|---|
| 06-82
14cm
1x2 teeth
Straight | 06-83
14cm
1x2 teeth
Curved |
|---|---|

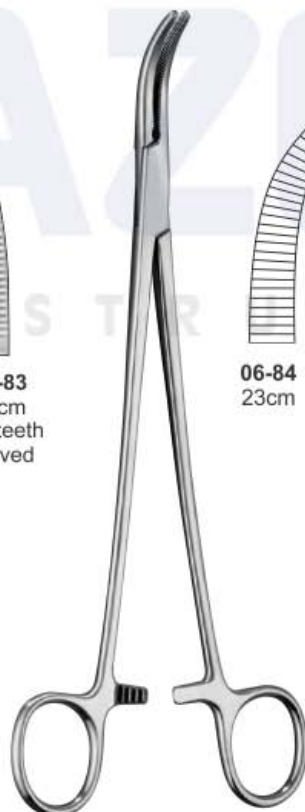

Moynihan Haemostatic Forceps

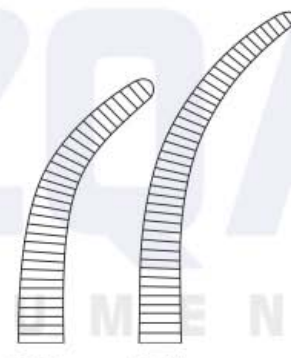

- | | |
|----------------------|----------------------|
| 06-84
23cm | 06-85
24cm |
|----------------------|----------------------|



Negus Haemostatic Forceps

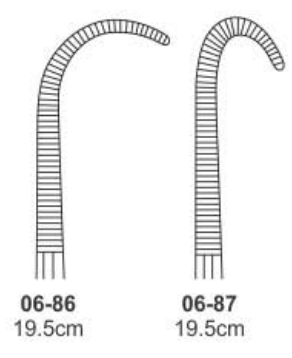

- | | |
|------------------------|------------------------|
| 06-86
19.5cm | 06-87
19.5cm |
|------------------------|------------------------|

Arterienklemmen
Pincas Hemostatiques

Pinzas Hemostaticas
Pinze Emostatiche



- 06-88 14cm
- 06-89 16cm
- 06-90 18.5cm
- 06-91 20cm
- 06-92 22.5cm
- 06-93 24cm
- 06-94 25.4cm
- 06-95 28cm
- 06-96 30.5cm
- 06-97 35.6cm
- 06-98 40.5cm
- 06-99 45.5cm
- 06-100 50.8cm
- 06-101 55.6cm
- 06-102 60cm
- straight

Rochester-Pean Haemostatic Forceps Straight



- 06-103 14cm
- 06-104 16cm
- 06-105 18.5cm
- 06-106 20cm
- 06-107 22.5cm
- 06-108 24cm
- 06-109 25.4cm
- 06-110 28cm
- 06-111 30.5cm
- 06-112 35.6cm
- 06-113 40.5cm
- 06-114 45.5cm
- 06-115 50.8cm
- 06-116 55.6cm
- 06-117 60cm
- Curved

Rochester-Pean Haemostatic Forceps Curved



- 06-118 18.5cm
- 1x2 teeth

Mikulicz Haemostatic Tissue Forceps



- 06-119 16cm
- 06-120 18.5cm
- 06-121 20cm
- 06-122 22.5cm
- 06-123 24cm
- 06-124 26cm
- Straight
- 1x2 teeth

Kocher-Ochsner Haemostatic Forceps 1x2 teeth

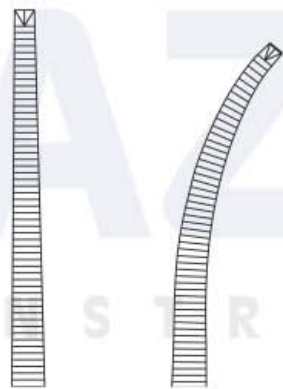

- 06-125 16cm
- 06-126 18.5cm
- 06-127 20cm
- 06-128 22.5cm
- 06-129 24cm
- 06-130 26cm
- Curved
- 1x2 teeth

Rochester-Ochsner Haemostatic Forceps 1x2 teeth



- 06-131 14cm
- 06-132 15cm
- 06-133 16cm
- 06-134 18cm
- 06-135 20cm
- 06-136 22cm
- 06-137 24cm
- 06-138 26cm
- 06-139 28cm
- 06-140 25cm



- 06-141 14cm
- 06-142 15cm
- 06-143 16cm
- 06-144 18cm
- 06-145 20cm
- 06-146 22cm
- 06-147 24cm
- 06-148 26cm
- 06-149 28cm
- 06-150 25cm

Arterienklemmen
Pinces Hemostatiques

Pinzas Hemostaticas
Pinze Emostatiche



06-151
Serrated
21.5cm

06-152
1x2 teeth
21.5cm

Φ
⊕



Halsted Haemostatic Forceps

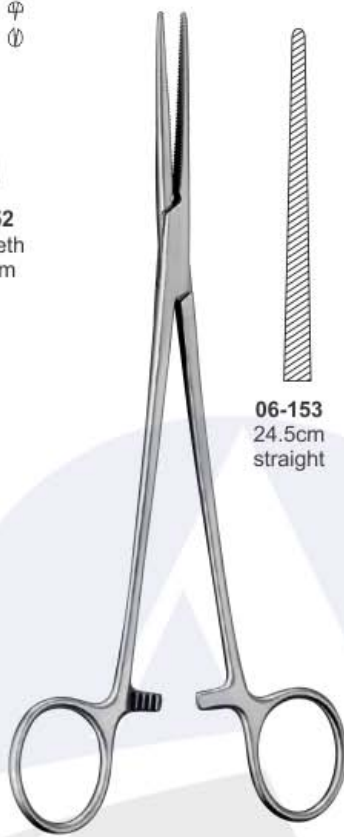

06-153
24.5cm
straight

06-154
24.5cm
Curved

Bengolea Haemostatic Forceps

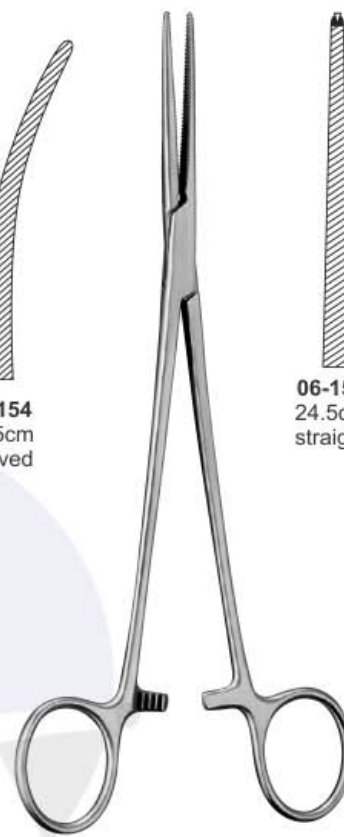

06-155
24.5cm
straight

06-156
24.5cm
Curved

Bengolea Haemostatic Tissue Forceps
(rat tooth 1x2 teeth)



06-157 14cm
06-158 16.5cm
06-159 19cm
06-160 21.5cm
06-161 24cm

Mixer-O'Shaughnessy
Haemostatic Forceps



06-162 14cm
06-163 16.5cm
06-164 19cm
06-165 21.5cm
06-166 24cm
micro point

Mixer-O'Shaughnessy
Haemostatic Forceps



06-167
24.5cm

Craford Haemostatic Forceps

Arterienklemmen
Pincas Hemostatiques

Pinzas Hemostaticas
Pinze Emostatiche



Herrick Haemostatic Forceps
06-168 23cm

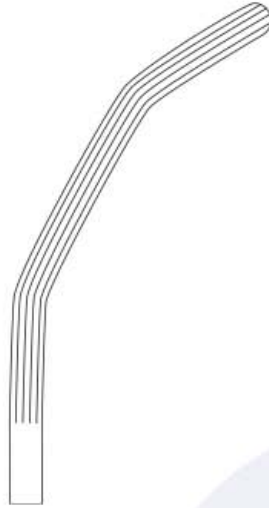

Roberts Haemostatic Forceps

06-169
22cm
straight

06-170
22cm
Curved



**Dixon-Lovelace
Haemostatic Tissue Forceps**



06-171
15.5cm
straight
(1x2teeth)

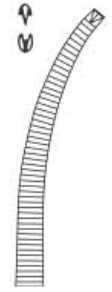

06-172
15.5cm
Curved
(1x2teeth)



**Crafoord-Sellors
Haemostatic Forceps**

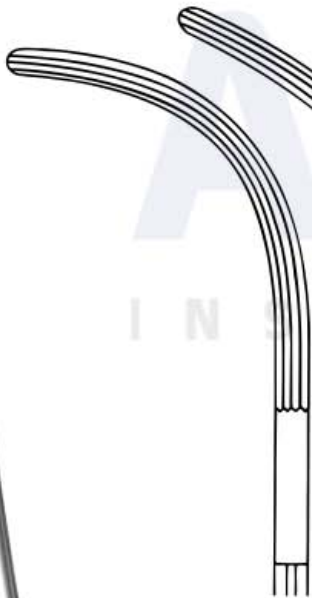

06-173
22cm

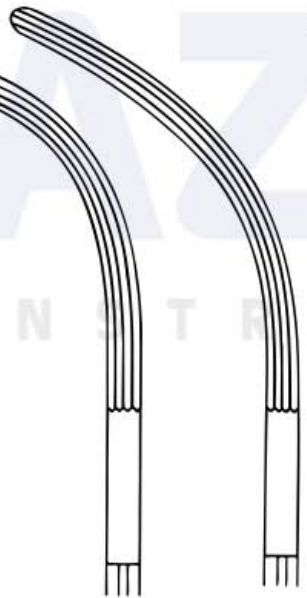

06-174
23cm



06-175
24cm



**Heaney / Ballantine
Haemostatic Forceps**



06-176
20cm
Straight,
Serrated

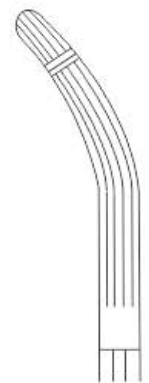

06-177
20cm
Slight Curve,
Serrated

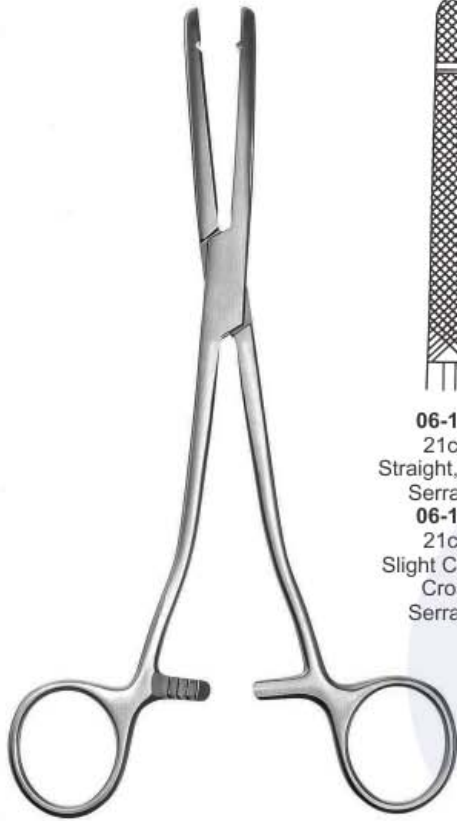

**Heaney / Rezak
Haemostatic Forceps**

06-178
21cm
Straight, Cross
Serrated
06-179
21cm
Slight Curved,
Cross
Serrated



Stille Haemostatic Forceps
06-180 23cm

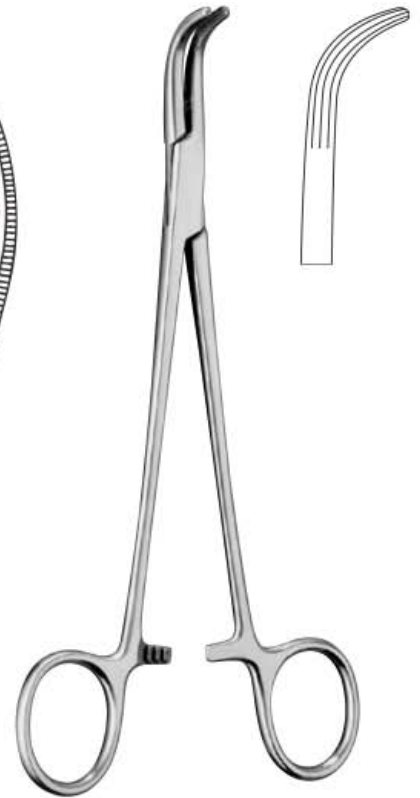

Lower Haemostatic Forceps
06-181 18cm



**Lahey (Sweet)
Haemostatic Forceps**

06-182
19cm
06-183
22cm



**Desjardins Haemostatic
Forceps**
06-184 22cm



**Mixer Haemostatic
Gall Duct Forceps**

06-185
22cm

06-186
25cm

Arterienklemmen
Pincas Hemostatiques

Pinzas Hemostaticas
Pinze Emostatiche



**Mixer Forceps,
06-188** 18.4cm
Fully curved,
original model

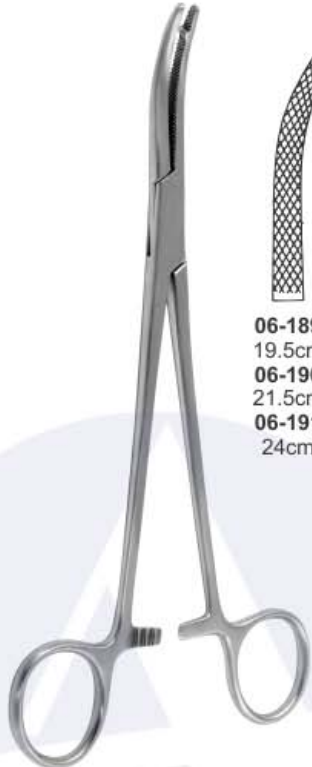

06-189
19.5cm
06-190
21.5cm
06-191
24cm

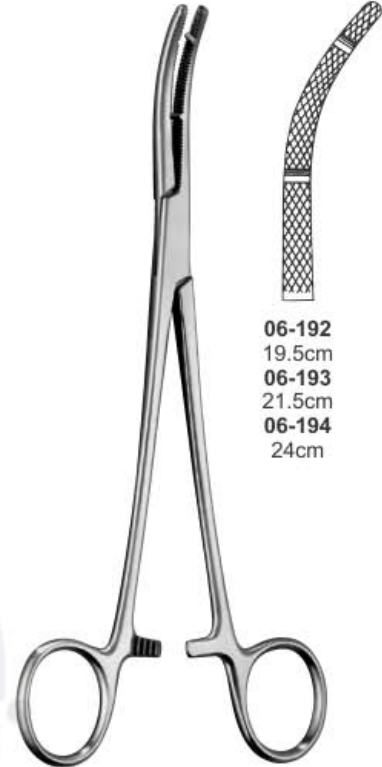

06-192
19.5cm
06-193
21.5cm
06-194
24cm

**Mixer Forceps, Lee Modif
06-187** 13.3cm
Curved jaws and angled
shanks, delicate

Heaney Haemostatic Forceps

**Heaney Modif. Haemostatic
Forceps**

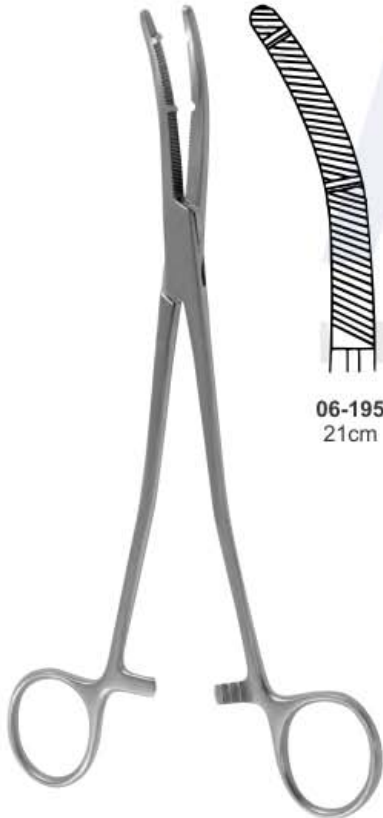

06-195
21cm

**Heaney-Kanter
Haemostatic Forceps**

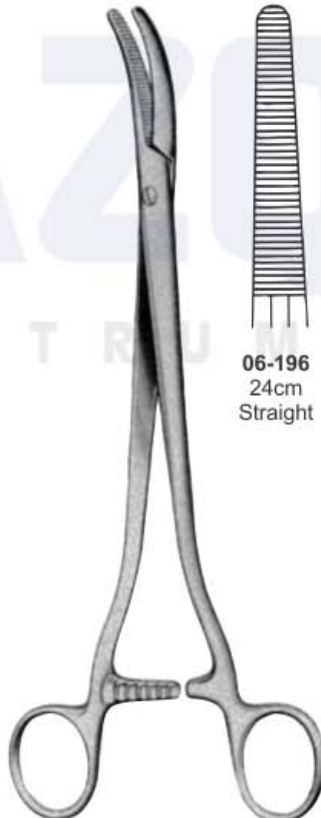

06-196
24cm
Straight

06-197
24cm
Curved

**Segond-Landau
Haemostatic Forceps**



06-198
1x2 teeth
20cm

**Schindler Haemostatic Tissue
Forceps**

Arterienklemmen
Pinces Hemostatiques

Pinzas Hemostaticas
Pinze Emostatiche

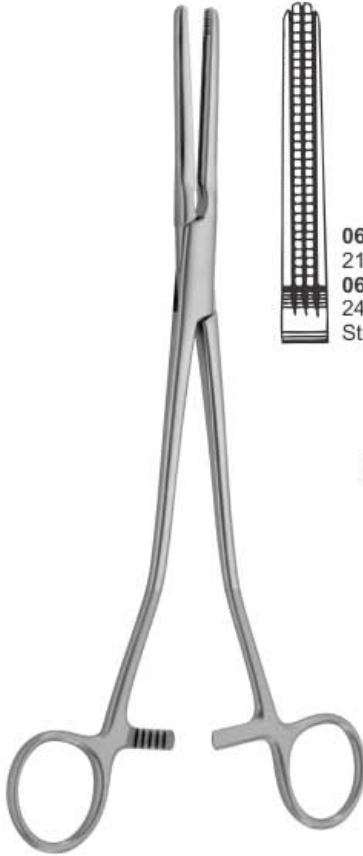

Parametrium Haemostatic Forceps

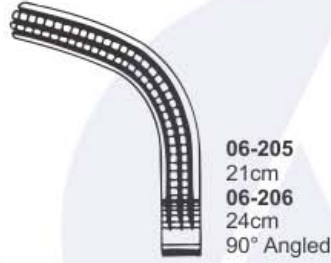
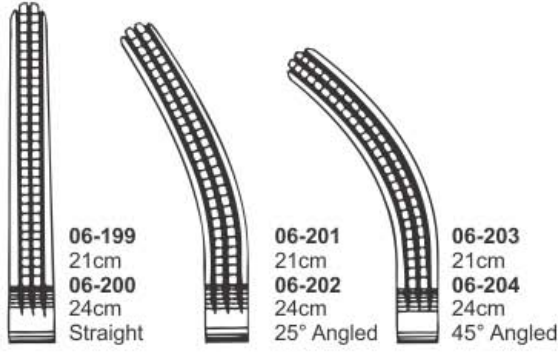

Bozemann Haemostatic Forceps

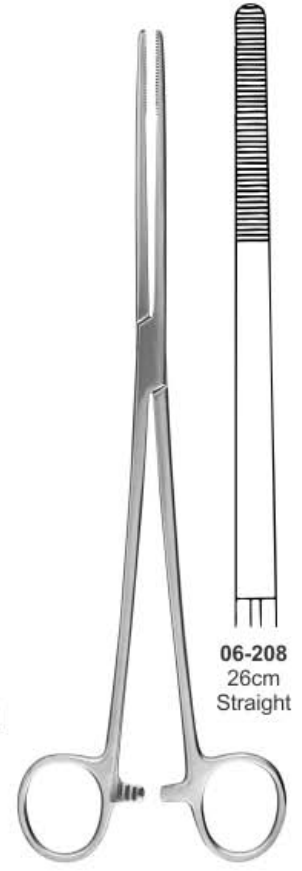

Bozemann Haemostatic Forceps



Westermark Haemostatic Forceps



Phaneuf Haemostatic Tissue Forceps

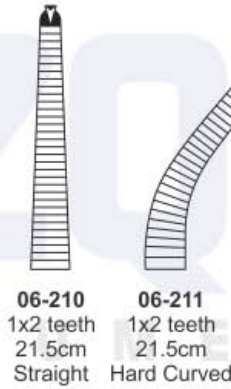

Long Haemostatic Tissue Forceps

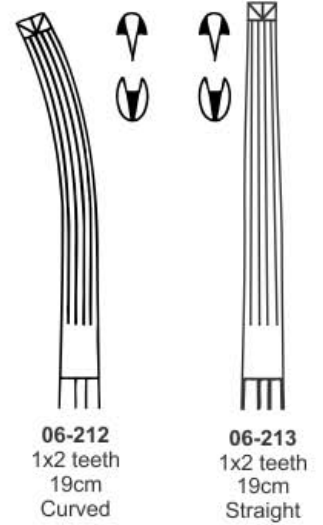

Arterienklemmen
Pinces Hemostatiques

Pinzas Hemostaticas
Pinze Emostatiche



Baby-Mikulicz Haemostatic Tissue Forceps



Mikulicz Haemostatic Tissue Forceps



Mikulicz Haemostatic Tissue Forceps



Mikulicz Haemostatic Tissue Forceps



Mikulicz Haemostatic Tissue Forceps



Faure Haemostatic Tissue Forceps

Arterienklemmen
Pincas Hemostatiques

Pinzas Hemostaticas
Pinze Emostatiche



06-220
1x2 teeth
23.5cm

Wertheim Haemostatic Tissue Forceps



06-221
1x2 teeth
24.5cm

Wertheim Haemostatic Tissue Forceps



06-222
25.5cm

Wertheim Hysterectomy Forceps

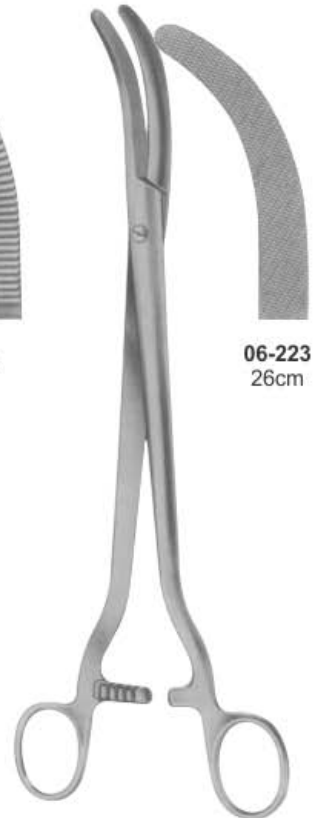

06-223
26cm

Wertheim Parametrium Clamp



Heaney Atraumata Hysterectomy Forceps

06-224
22.5cm
Straight

06-225
22.5cm
25° Angled

06-226
21.5cm
45° Angled

06-227
20.5cm
90° Angled



Wertheim Parametrium Clamps

06-228
25cm
Straight

06-229
24.5cm
25° Angled

06-230
24cm
45° Angled

06-231
22cm
90° Angled

Arterienklemmen
Pinces Hemostatiques

Pinzas Hemostaticas
Pinze Emostatiche



Gemini Mixer Hemostatic Forceps
06-232 14cm
06-233 17.75cm
full curve, delicate



Dick Haemostatic Forceps



06-234 25.5cm
06-235 26.5cm
06-236 27.5cm



06-237
21.5cm



Wertheim-Cullen Haemostatic Forceps



Wertheim-Cullen Haemostatic Forceps
23cm



06-238
60mm

06-239
80mm

06-240
25cm

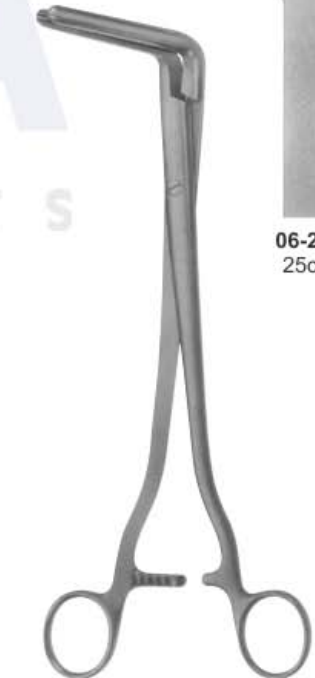

Wertheim Haemostatic Forceps



Jones / Perforating Towel Forceps 06-241 9 cm Slight Curve
Jones-Martin Towel Clamp sharp 06-242 8.5 cm
Engl. Modell Towel Forceps 06-243 9 cm
Schaedel Towel Forceps 06-244 9 cm
Thomson-Walker's Penile Clamps 06-245 9 cm Cross-Action model.
Doyen 06-246 11 cm
Doyen Towel Forceps 06-247 18 cm
Fricke Artery Forceps 06-248 13 cm

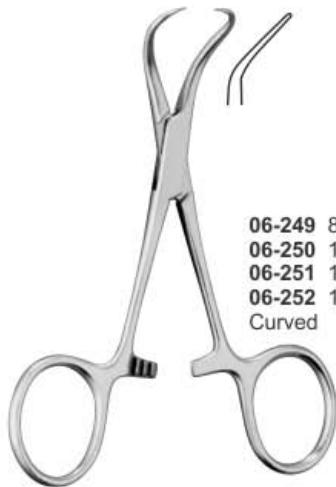

06-249 8cm
06-250 11cm
06-251 13cm
06-252 15cm
Curved

Backhaus Towel Forceps



Backhaus Clip Towel Forceps
06-253 11cm
with clip for tubing or cable



Roeder Towel Forceps
06-254 13cm
06-255 15cm
Curved, Serrated



Lorna Towel Forceps
06-256 9cm
06-257 11.4cm
06-258 13.5cm



Ball & Socket Towel Forceps
06-259 13cm
Non-perforating



Tohoku Towel Forceps
06-260 10cm
06-261 13cm
Non-Perforating



Non-Perforating Towel Forceps
06-262 11cm
06-263 13cm



Peers-Bertman Towel Forceps
06-264 14.5cm
Serrated

Arterienklemmen
Pincas Hemostatiques

Pinzas Hemostaticas
Pinze Emostatiche



Bernhard Towel Forceps
06-265 16.5cm



Presbyterian Tubing Clamp
06-266 16.5cm
06-267 18cm
Straight, Smooth



Tubing Clamp
06-268 18cm
06-269 20cm
Cross Serrated

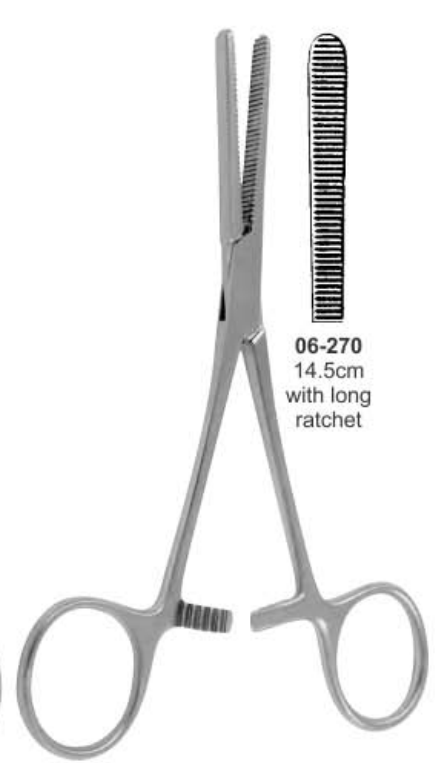

06-270
14.5cm
with long
ratchet



Tubing Clamp with Protector
Cross Serrated

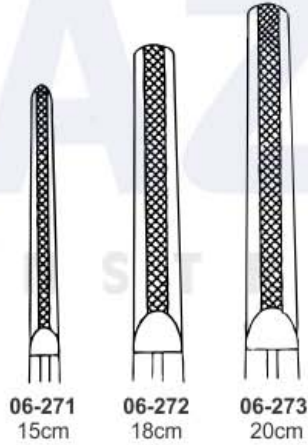

06-271 15cm
06-272 18cm
06-273 20cm

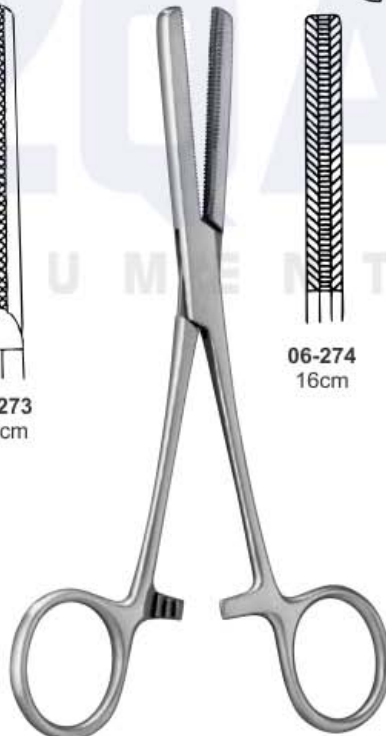

Fergusson Tubing Clamp

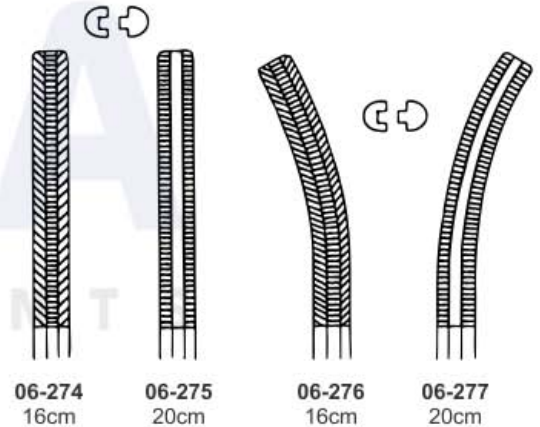

06-274 16cm
06-275 20cm
06-276 16cm
06-277 20cm



Tuffier Haemostatic Forceps
06-278 13cm



Chaput Haemostatic Forceps
06-279 13cm



Pratt Haemostatic Forceps
06-280 15cm



Pennington / Siezing Haemostatic Forceps
06-281 15.5cm
06-282 20cm
Straight



Martel Haemostatic Forceps
06-283 14cm



Willet-Martel Haemostatic Forceps
06-284 19cm

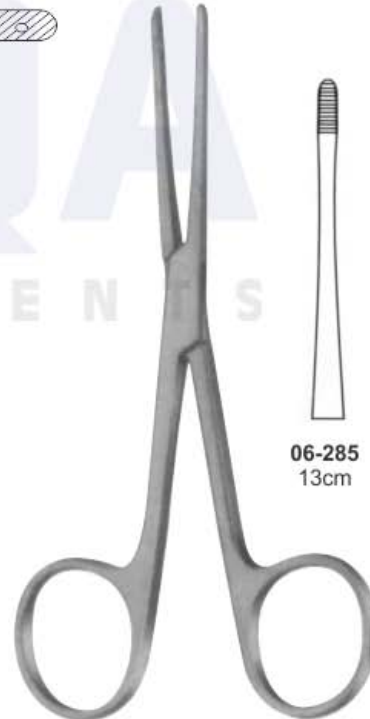

Lister Sinus Forceps

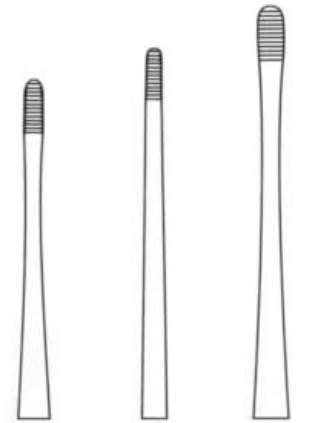

06-285
13cm

06-286
15.5cm

06-287
17.5cm

Arterienklemmen
Pinces Hemostatiques

Pinzas Hemostaticas
Pinze Emostatiche



06-288
12.5cm

06-289
14cm

**Collin Dressing
Haemostatic Forceps**

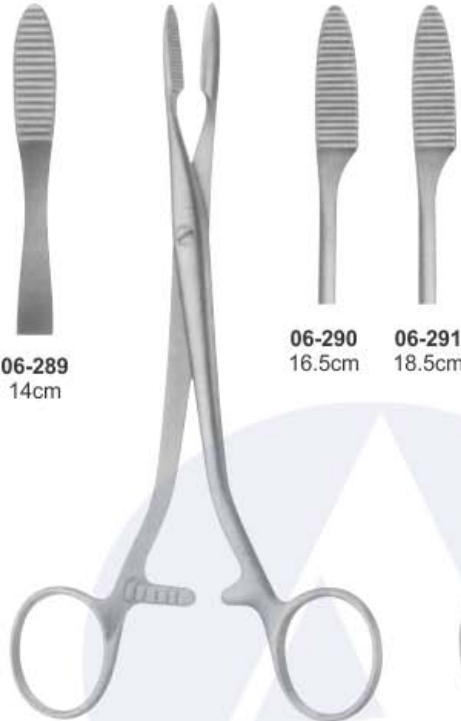

06-290
16.5cm

06-291
18.5cm

**Collin Dressing
Haemostatic Forceps**



Gross Maier Dressing Forceps
06-292 14.5cm straight
Without Ratchet

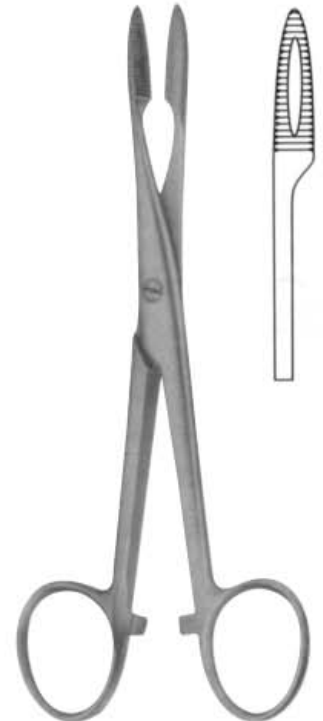

Gross Maier Dressing Forceps
06-293 14.5cm straight
With Ratchet



Gross Maier Dressing Forceps
06-294 14.5cm, curved
With Ratchet



Gross Maier Dressing Forceps
06-295 14.5cm, curved
With Ratchet



**Gross Maier Dressing
Sponge & Dressing Forceps**
06-296 20.5cm, straight
Without Ratchet

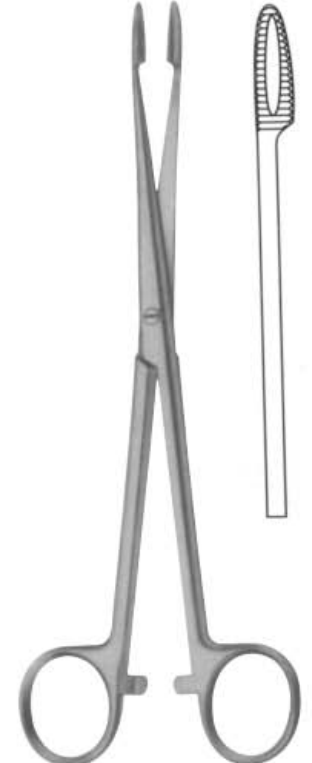

**Gross Maier Dressing
Sponge & Dressing Forceps**
06-297 17.8cm, straight
With Ratchet

Arterienklemmen
Pinces Hemostatiques

Pinzas Hemostaticas
Pinze Emostatiche

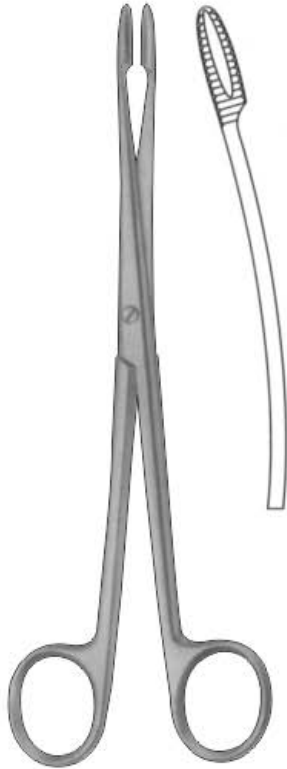

**Gross Maier Dressing
Sponge & Dressing Forceps**
06-298 20.5cm, curved
Without Ratchet
(bullet holding forceps)

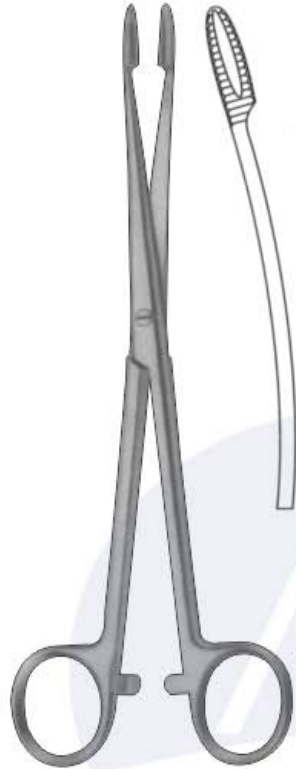

**Gross Maier Dressing
Sponge & Dressing Forceps**
06-299 17.8cm, curved
With Ratchet



Gross Maier Dressing Forceps
06-300 26.5cm, straight
Without Ratchet
(bullet holding forceps)

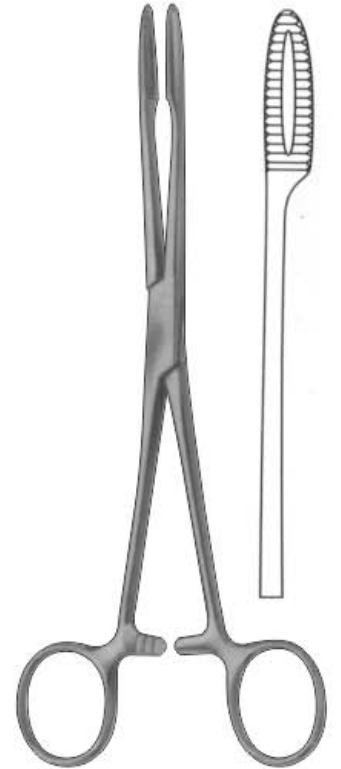

Gross Maier Dressing Forceps
06-301 26.5cm, straight
With Ratchet
(bullet holding forceps)

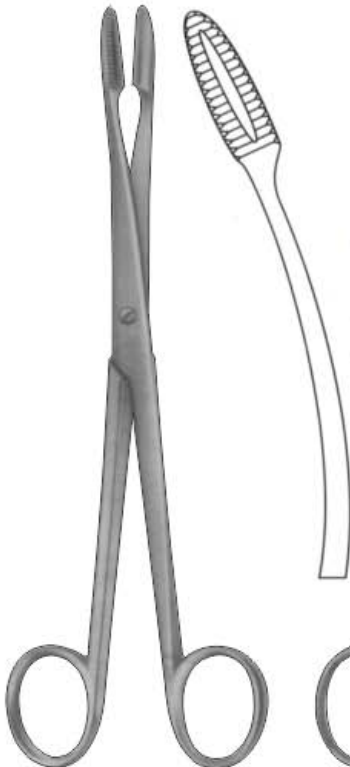

Gross Maier Dressing Forceps
06-302 26.5cm, curved
Without Ratchet
(bullet holding forceps)

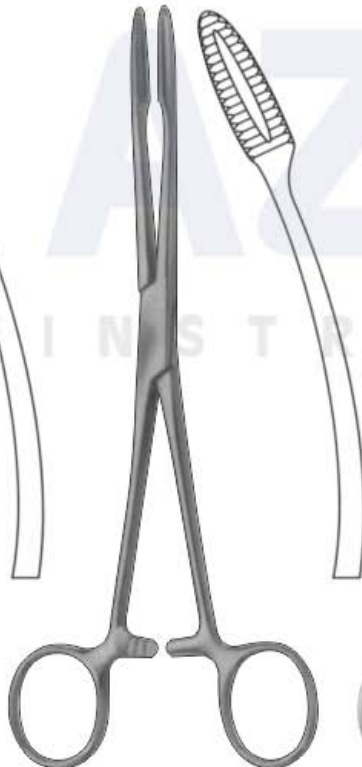

Gross Maier Dressing Forceps
06-303 26.5cm, curved
With Ratchet
(bullet holding forceps)



**Collin Sponge &
Dressing Forceps**

06-304
24cm



**Duplay Sponge &
Dressing Forceps**
06-305 19cm
Slight Curve



06-306
28cm
Straight

06-307
28cm
Curved

Sims-Maier Sponge & Dressing Forceps



06-308
22cm
Straight

06-309
25cm
06-310
27cm
Straight

Ulrich Sponge Forceps

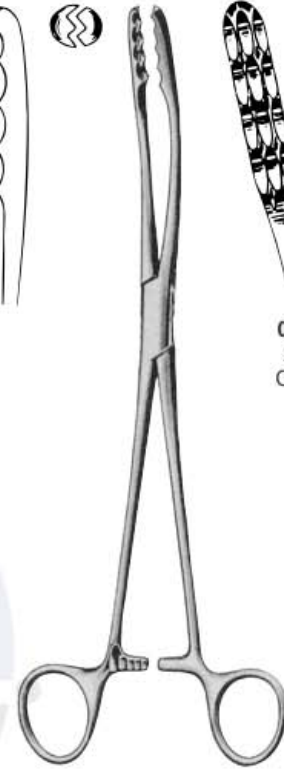

06-311
22cm
Curved

06-312
25cm
06-313
27cm
Curved

Ulrich Sponge Forceps



06-314
22cm
Straight

06-315
22cm
Curved

Aesculap Sponge & Dressing Forceps



06-316
24cm
Straight

Fletcher Sponge Forceps



06-317
24cm
Slight Curve

Fletcher Sponge Forceps

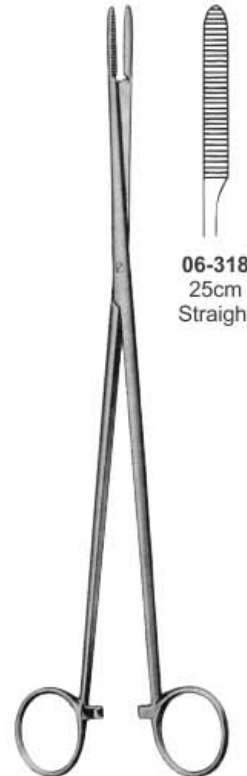

06-318
25cm
Straight

Pelkmann Sponge Forceps

Arterienklemmen
Pincas Hemostatiques

Pinzas Hemostaticas
Pinze Emostatiche

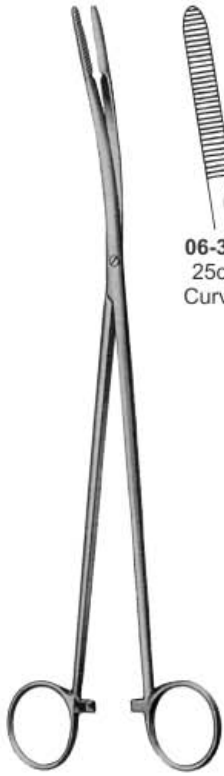

06-319
25cm
Curved

Pelkmann Sponge Forceps



06-320
24cm

Cheron Forceps
Handles Laterally
Angled



06-321
20.5cm
Straight

Duplay Sponge Forceps



06-322
20.5cm
Curved

Duplay Sponge Forceps



Heywood Smith Sponge Forceps
06-323 25cm

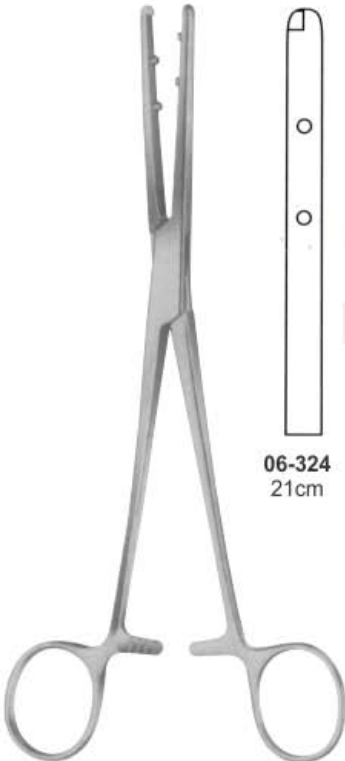

06-324
21cm

Emmet Sponge & Dressing Forceps



Tendon Seizing Forceps



Herz Tendon Seizing Forceps



06-325
15.5cm



06-326
15.5cm
coarse
serration

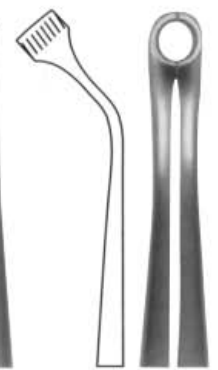

06-327
15.5cm
fine
serrations

Arterienklemmen
Pinces Hemostatiques

Pinzas Hemostaticas
Pinze Emostatiche



Noto Sponge & Dressing Forceps
06-328 28cm

Kelly Sponge & Dressing Forceps

06-329
32cm
Curved

06-330
32cm
Straight

Heywood-Smith Sponge & Dressing Forceps
06-331 20cm

Collin Sponge & Dressing Forceps

06-332
16cm
06-333
17cm

06-334
16cm



Foerster-Ballenger Sponge Forceps
& (bullet holding forceps)



06-335 18cm
06-336 20cm
06-337 24cm
Straight Smooth

06-338 18cm
06-339 20cm
06-340 24cm
Straight Serrated



06-341 18cm
06-342 20cm
06-343 24cm
Curved Smooth

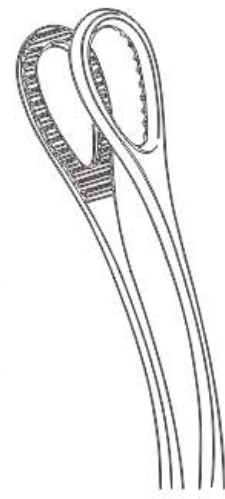

06-344 18cm
06-345 20cm
06-346 24cm
Curved Serrated

NEEDLE HOLDERS



Nadelhalter
Prote-aiguilles

Porta-agujas
Porta aghi

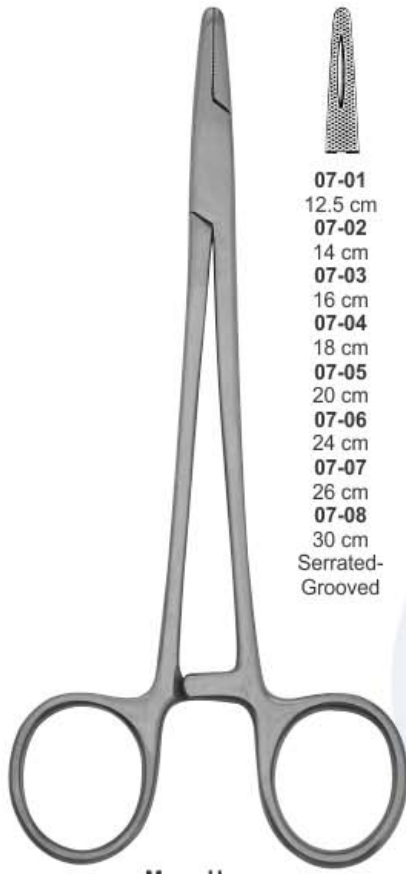

**Mayo-Hegar
Needle Holders**

07-01 12.5 cm	07-09 12.5 cm	07-17 16 cm	07-20 12.5 cm	07-28 12.5 cm	07-36 12.5 cm
07-02 14 cm	07-10 14 cm	07-18 18 cm	07-21 14 cm	07-29 14 cm	07-37 14 cm
07-03 16 cm	07-11 16 cm	07-19 20 cm	07-22 16 cm	07-30 16 cm	07-38 16 cm
07-04 18 cm	07-12 18 cm	Serrated- Grooved left handed	07-23 18 cm	07-31 18 cm	07-39 18 cm
07-05 20 cm	07-13 20 cm		07-24 20 cm	07-32 20 cm	07-40 20 cm
07-06 24 cm	07-14 24 cm		07-25 24 cm	07-33 24 cm	07-41 24 cm
07-07 26 cm	07-15 26 cm		07-26 26 cm	07-34 26 cm	07-42 26 cm
07-08 30 cm	07-16 30 cm		07-27 30 cm	07-35 30 cm	07-43 30 cm
Serrated- Grooved	Serrated		Serrated- Grooved Curved	Serrated Curved	Serrated-Solid

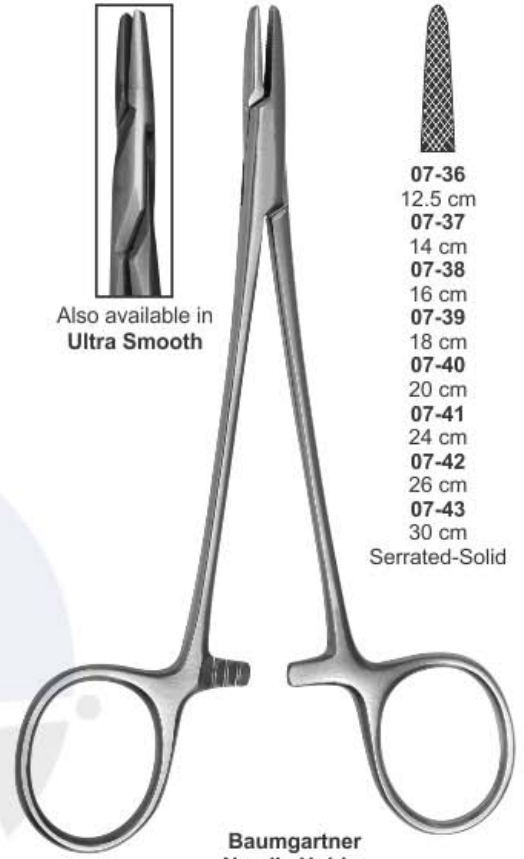

**Baumgartner
Needle Holder**

Also available in
Ultra Smooth



**Webster
Needle Holder**

Also available in
Ultra Smooth



07-44 11.5 cm
07-45 12 cm
07-46 12.5 cm
07-47 13 cm
07-48 14 cm
07-49 15 cm
07-50 18 cm
07-51 20 cm
Smooth



**Brown
Needle Holder**

Also available in
Ultra Smooth



07-52 13 cm
07-53 18 cm
Serrated-Solid



**Baby Crile-Wood
Needle Holder**

Also available in
Ultra Smooth



07-54 15 cm

Nadelhalter
Prote-aiguilles

Porta-agujas
Porta aghi

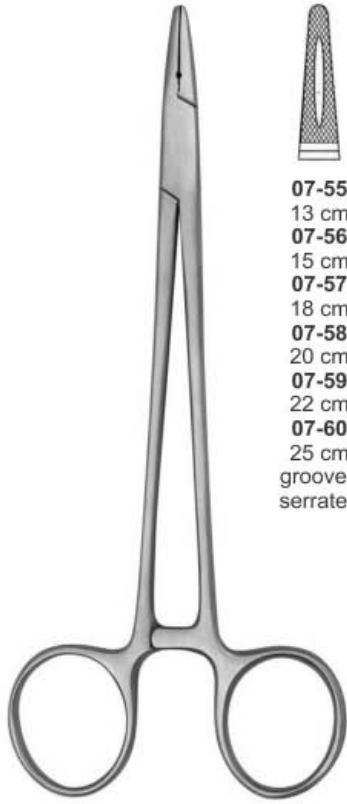

**Crile-Wood
Needle Holder**

07-55
13 cm
07-56
15 cm
07-57
18 cm
07-58
20 cm
07-59
22 cm
07-60
25 cm
grooved
serrated

07-61
13 cm
07-62
15 cm
07-63
18 cm
07-64
20 cm
07-65
22 cm
07-66
25 cm
solid
serrated

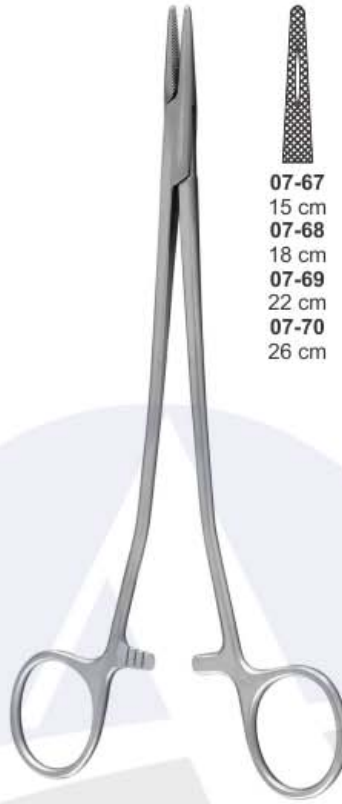

Sarot Needle Holders

07-67
15 cm
07-68
18 cm
07-69
22 cm
07-70
26 cm



Bozemann Needle Holders

07-71
20 cm
07-72
24 cm
07-73
26 cm
07-74
30 cm



Also available in
Ultra Smooth

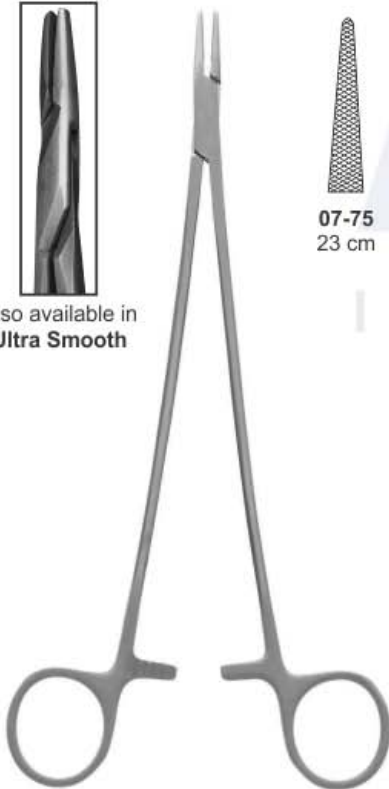

Jameson Needle Holders

07-75
23 cm

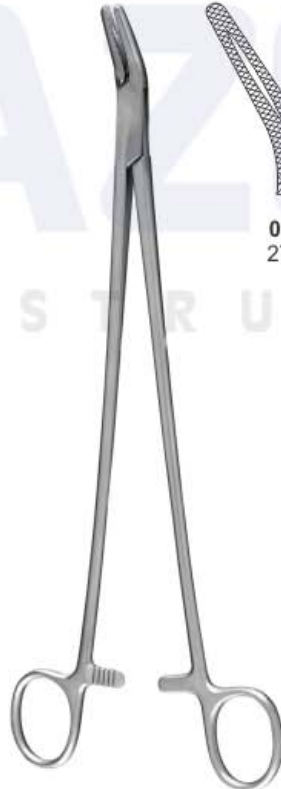

Finocchietto Needle Holders

07-76
27 cm



Also available in
Ultra Smooth

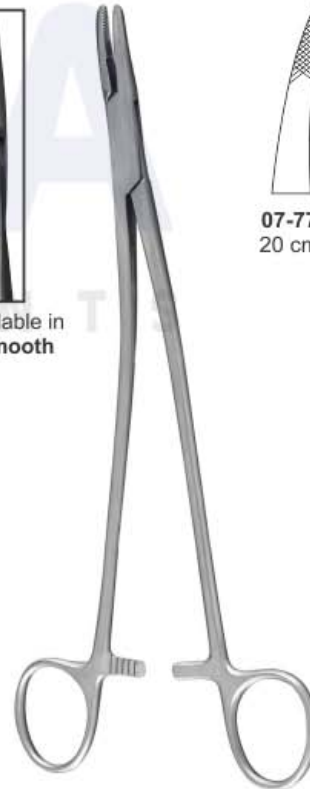

Stratte Needle Holders

07-77
20 cm

07-78
23 cm

Nadelhalter
Prote-aiguilles

Porta-agujas
Porta aghi

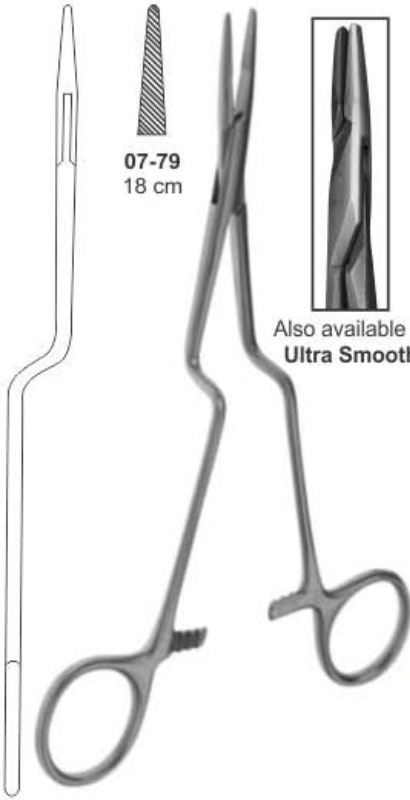

07-79
18 cm

Also available in
Ultra Smooth

Jacobson Needle Holders

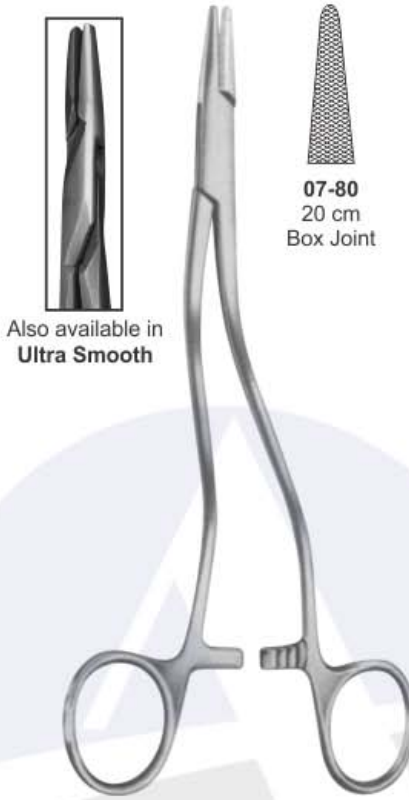

07-80
20 cm
Box Joint

Also available in
Ultra Smooth

**Thomson Walker
Needle Holders**



07-81 18 cm
07-82 25 cm
Pound Action Joint.

Naunton Morgan Needle Holders



07-83
17 cm

**Mass. General Hospital
Needle Holders**



07-84
18 cm

Adson Needle Holders



07-85
18 cm

New Orleans Needle Holders

Nadelhalter
Prote-aiguilles

Porta-agujas
Porta aghi

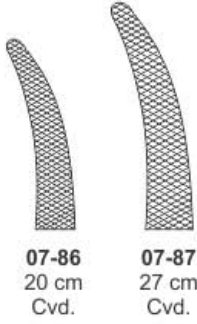

Heaney Needle Holders

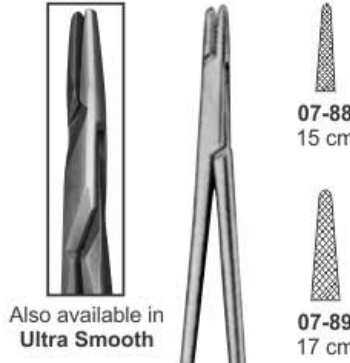
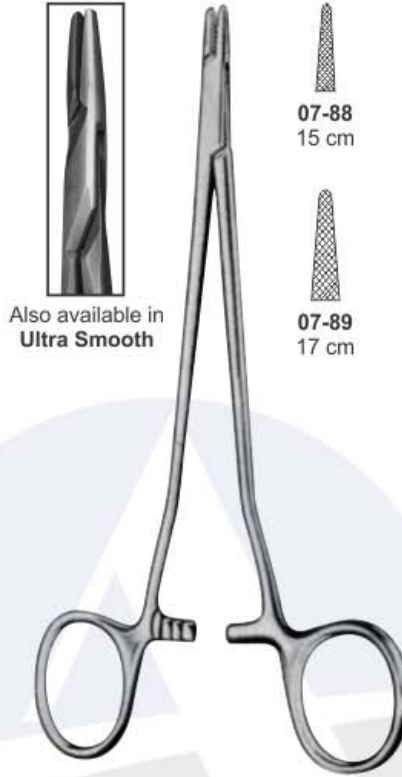

**Senning Needle Holders
(Schwed. Model)**

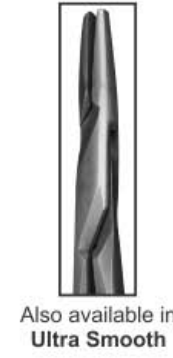
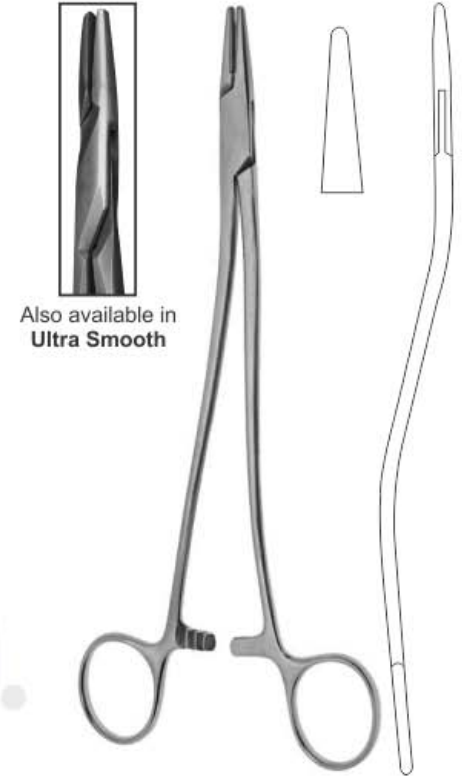

Wertheim Needle Holders

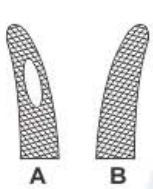

Gillies Needle Holders
07-92 16 cm



**Masson-Luethy
Needle Holders**

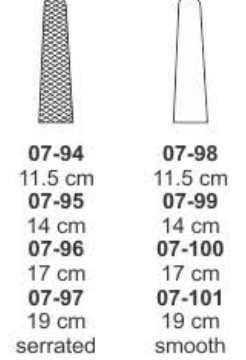

Olsen-Hegar Needle Holders

Nadelhalter
Prote-aiguilles

Porta-agujas
Porta aghi



07-102
13 cm
serrated

07-103
13 cm
smooth

Halsey Needle Holders

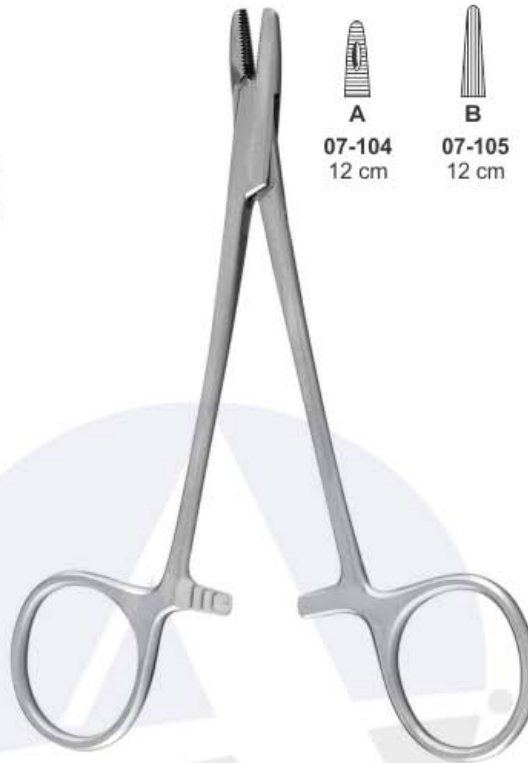

A
07-104
12 cm

B
07-105
12 cm

B
07-106
12 cm

Derf Needle Holders

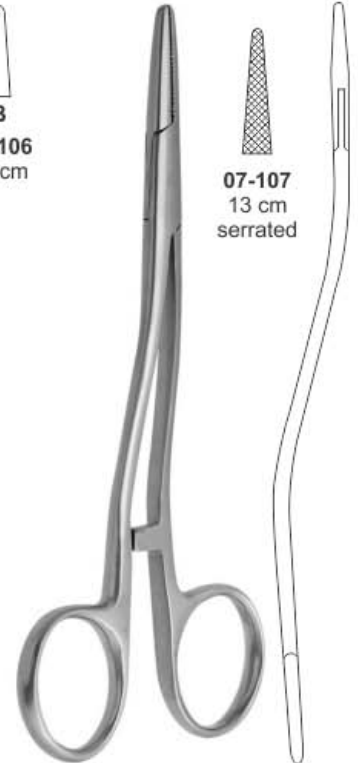

07-107
13 cm
serrated

Kilner Needle Holders



07-108
13 cm

Neivert Needle Holders



07-109
12.5 cm

Collier Needle Holders



07-110
12.5 cm

Doyen Needle Holders

Nadelhalter
Prote-aiguilles

Porta-agujas
Porta aghi



07-111
15 cm
Slender
pattern

**Crile-Murray
Needle Holders**



07-112
18.5 cm
One grooved and
fenestrated jaw

**Metzenbaum
Needle Holders**



07-113
27 cm
Serrated-Solid

**Wangensteen
Needle Holders**



07-114
27 cm

Masson Needle Holder



Johnson Needle Holders

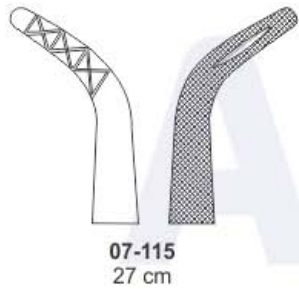

De Bakey Needle Holders

- 07-116 18 cm
- 07-117 20 cm
- 07-118 22 cm
- 07-119 25 cm



Intracardiac Needle Holders

- 07-120 18 cm
- 07-121 20 cm
- 07-122 22 cm
- 07-123 25 cm



Microvascular Needle Holders

- 07-124 18 cm
- 07-125 20 cm
- 07-126 22 cm
- 07-127 25 cm

Nadelhalter
Prote-aiguilles

Porta-agujas
Porta aghi

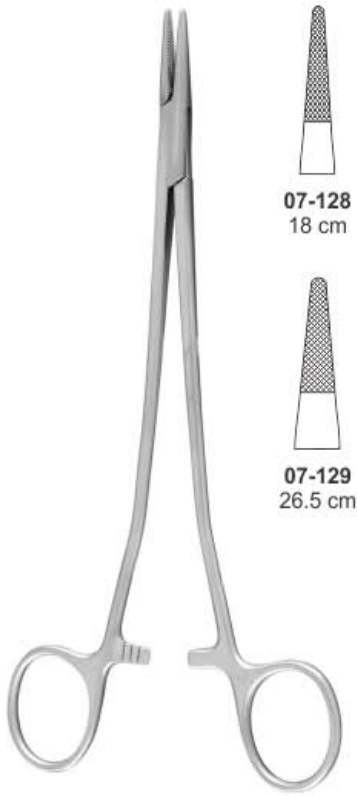

07-128
18 cm



07-129
26.5 cm

Sarot Needle Holders



07-130
15 cm
07-131
18 cm
07-132
20 cm

Micro Ryder Needle Holders

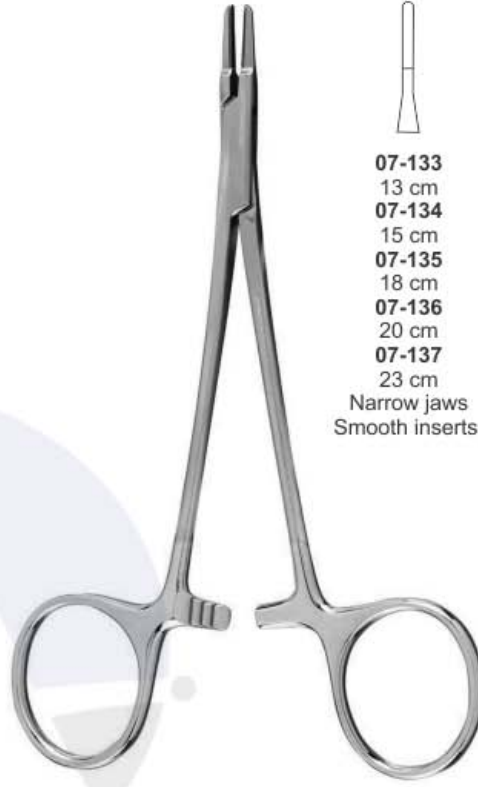

07-133
13 cm
07-134
15 cm
07-135
18 cm
07-136
20 cm
07-137
23 cm
Narrow jaws
Smooth inserts.



07-138
13 cm
07-139
15 cm
07-140
18 cm
07-141
20 cm
07-142
23 cm
Narrow jaws
serrated

Ryder Needle Holders
Narrow jaws.



French-Eye Needle Holder
07-143 16 cm
07-144 18 cm
07-145 20 cm
07-146 22 cm
07-147 25 cm
Narrow Tip



French-Eye Needle Holder
07-148 16 cm
07-149 18 cm
07-150 20 cm
07-151 22 cm



07-152
18 cm
07-153
20 cm
07-154
23 cm
07-155
26 cm

**Cooley Intracardiac
Needle Holders**
Straight, narrow jaw.

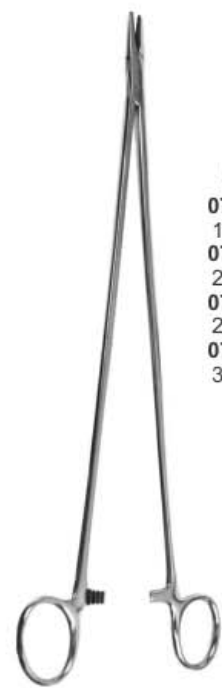

07-156
18 cm
07-157
23 cm
07-158
27 cm
07-159
30 cm

**Debakey Cardiovascular
Needle Holders**
Delicate patterns.
Straight jaw, serrated.

Nadelhalter
Prote-aiguilles

Porta-agujas
Porta aghi



Finochietto Needle Holders
07-160 13 cm
07-161 16 cm
07-162 19 cm
07-163 21 cm



Finochietto Needle Holders
07-164 13 cm Angled
07-165 16 cm Angled
07-166 19 cm Angled

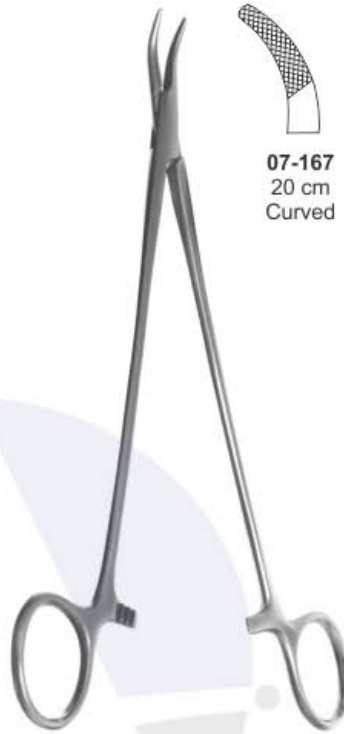

07-167
20 cm
Curved



07-168
14 cm
07-169
17 cm
07-170
20 cm

Mathieu Needle Holders



07-171
14 cm
07-172
16.5 cm
07-173
20 cm
Narrow Jaws

Mathieu Needle Holders



07-174
18 cm
07-175
23 cm

Mayo Rochester Needle Holders
button release, screw joint.



07-176
15 cm
07-177
18 cm
07-178
20 cm
lined with copper.

Macphail Needle Holders



07-179
15 cm

Crile Needle Holders

Nadelhalter
Prote-aiguilles

Porta-agujas
Porta aghi



07-180
18.5 cm

Toennis Needle Holders



07-181
13 cm
with lock
straight

07-182
13 cm
with lock
curved

07-183
13 cm
without lock
straight

07-184
13 cm
without lock
curved

Castroviejo Needle Holders



07-185
10 cm
07-186
14 cm
Straight, Smooth
with lock Straight

07-187
10 cm
07-188
14 cm
Curved, Smooth
with lock curved

Troutman
Needle Holders



**Barraquer Micro
Needle Holders**
07-189 11cm
07-190 13cm



**Barraquer
Needle Holders**

07-191
13 cm
Straight, Smooth
without lock
Straight

07-192
13 cm
Curved, Smooth
without lock
curved



07-193
14 cm
Straight
Smooth
with lock

07-194
14 cm
Straight
Smooth
without lock

07-195
14 cm
Curved
Smooth
with lock

07-196
14 cm
Curved
Smooth
without lock

07-197
18 cm
Straight
Smooth
with lock

07-198
18 cm
Straight
Smooth
without lock

07-199
18 cm
Curved
Smooth
with lock

07-200
18 cm
Curved
Smooth
without lock

**Castroviejo
Needle Holders**

Nadelhalter
Prote-aiguilles

Porta-agujas
Porta aghi



07-201
13 cm
07-202
15 cm

Castroviejo Olsen Hegar /
Needle Holders / Scissors



07-203
12 cm

Boynton Needle Holders



07-204
16 cm
Str.

Arruga Needle Holders



07-205
16 cm
Cvd.



Micro Needle Holders

07-206
19 cm
07-207
23 cm
Smooth
Str.

07-208
19 cm
07-209
23 cm
Smooth
Cvd.



07-210
16 cm
Smooth
Cvd.

Micro Needle
Holders



Castroviejo Needle
Holders

07-211
12 cm
Smooth Str
with lock

07-212
12 cm
Smooth Cvd
with lock



Barraquer-Troutman
Needle Holders

07-213
10 cm
07-214
11.5 cm
Smooth
Str.

07-215
10 cm
07-216
11.5 cm
Smooth
Cvd.



Kalt Needle Holders



07-217
14 cm
Serrated



Arruga Needle Holders

07-218
14 cm
Serrated
Str.

07-219
14 cm
Serrated
Cvd.



Nadelhalter
Prote-aiguilles

Porta-agujas
Porta aghi



- 07-220 14 cm
- 07-221 18 cm
- 07-222 20 cm
- 07-223 23 cm
- 07-224 25 cm

Microvascular
Needle Holders T.C.



- 07-225 15 cm
- 07-226 18 cm
- 07-227 20 cm

Micro Ryder Needle
Holders T.C.



- 07-228 13 cm
- 07-229 15 cm
- 07-230 18 cm
- 07-231 20 cm
- 07-232 22 cm
- 07-233 25 cm

Crile-Wood Needle
Holders T.C.

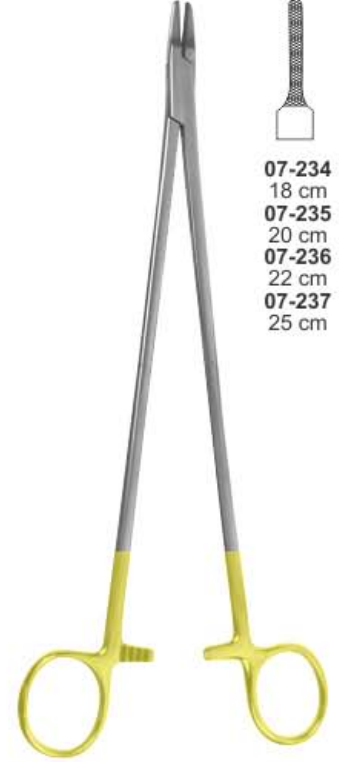

- 07-234 18 cm
- 07-235 20 cm
- 07-236 22 cm
- 07-237 25 cm

Intracardiac Needle Holders T.C.



- 07-238 18 cm

New Orleans Needle
Holders T.C.

- 07-239 18 cm
Serrated-Solid



- 07-240 15 cm
- 07-241 17 cm

Senning Needle Holders T.C.
(Schwed. Model)



- 07-242 15 cm
Serrated-Solid

Carroll Needle Holders T.C.

Nadelhalter
Prote-aiguilles

Porta-agujas
Porta aghi

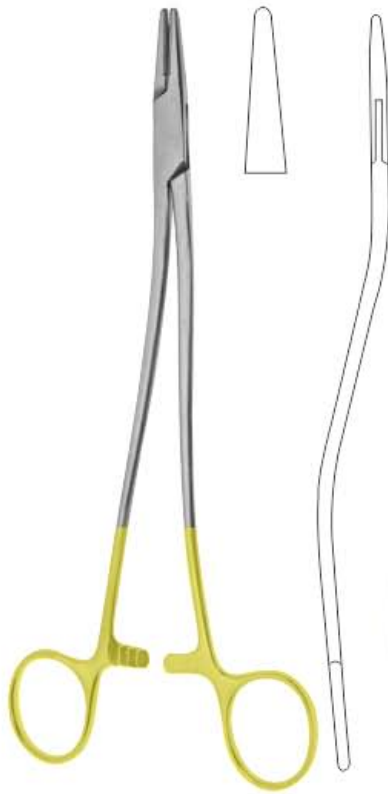

Werheim Needle Holders T.C
07-243 20 cm
07-244 24 cm



Kilner Needle Holders T.C

07-245
13 cm



Jacobson Needle Holders T.C

07-246
18 cm

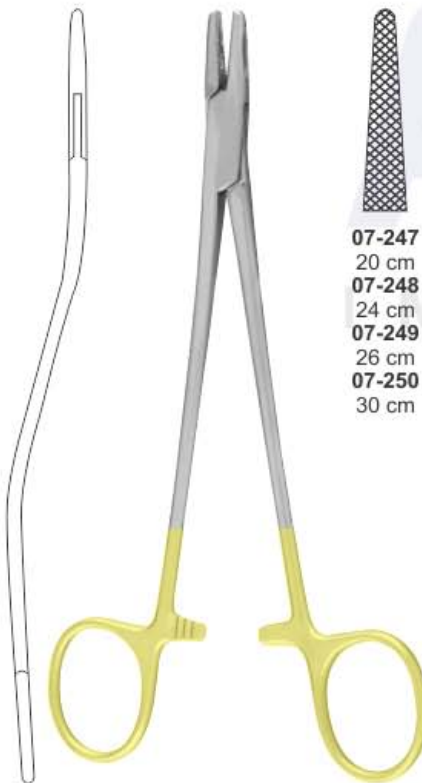

Bozemann Needle Holders T.C

07-247
20 cm
07-248
24 cm
07-249
26 cm
07-250
30 cm



Baumgartner Needle Holders T.C

07-251
13 cm
07-252
15 cm



Olsen-Hegar Needle Holders T.C

07-253
14 cm
07-254
17 cm
07-255
19 cm
Serrated-Solid

07-256
14 cm
07-257
17 cm
07-258
19 cm
Serrated-Solid

Nadelhalter
Prote-aiguilles

Porta-agujas
Porta aghi

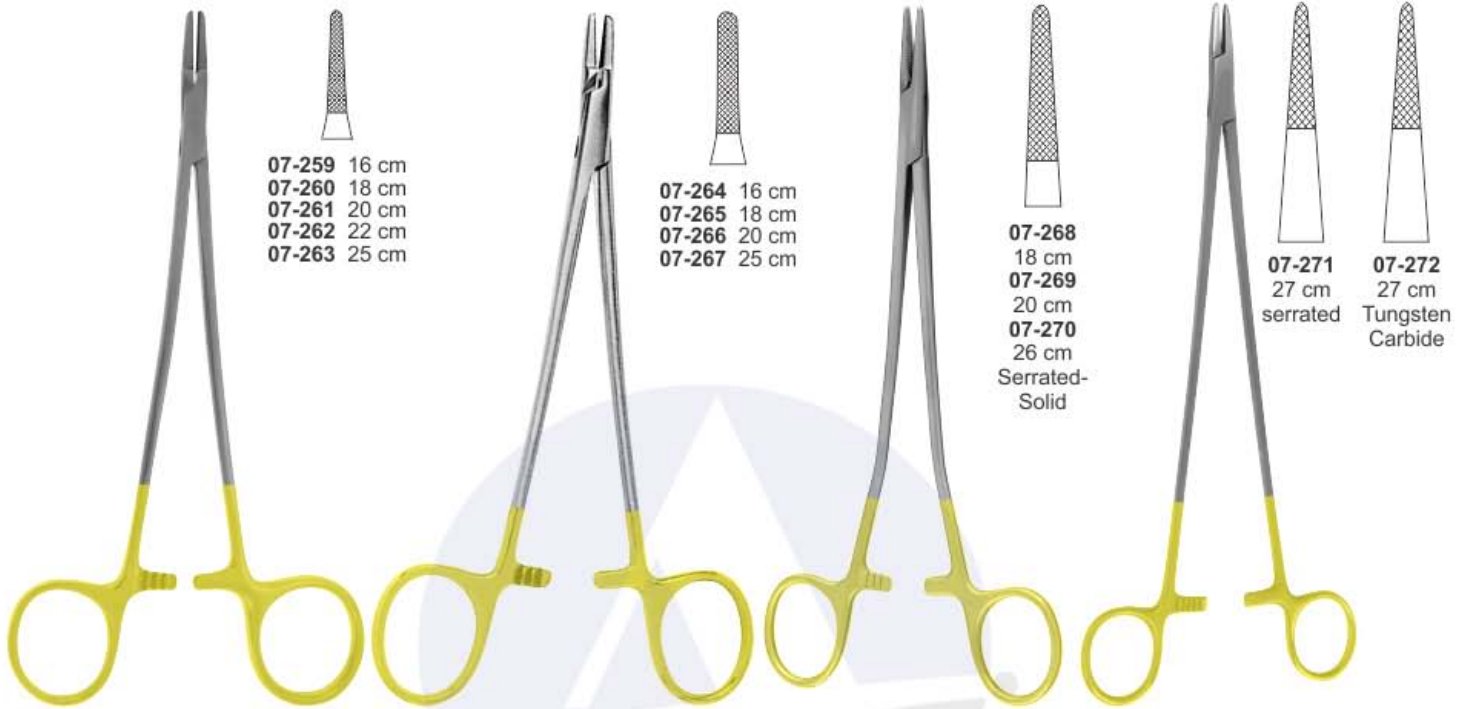

- 07-259 16 cm
- 07-260 18 cm
- 07-261 20 cm
- 07-262 22 cm
- 07-263 25 cm

- 07-264 16 cm
- 07-265 18 cm
- 07-266 20 cm
- 07-267 25 cm

- 07-268 18 cm
- 07-269 20 cm
- 07-270 26 cm
- Serrated-Solid

- 07-271 27 cm serrated
- 07-272 27 cm Tungsten Carbide

French-Eye Needle Holders T.C

French-Eye Needle Holders T.C

Sarot Needle Holders T.C

Wangensteen Needle Holders T.C



- 07-273 13 cm
- 07-274 16 cm
- 07-275 19 cm
- 07-276 21 cm

- 07-277 13 cm
- 07-278 16 cm
- 07-279 19 cm

- 07-280 15 cm
- 07-281 18 cm
- 07-282 20 cm
- 07-283 23 cm
- 07-284 25 cm
- 07-285 28 cm
- 07-286 30 cm
- Right handed.

- 07-287 15 cm
- 07-288 18 cm
- 07-289 20 cm
- 07-290 23 cm
- 07-291 25 cm
- 07-292 28 cm
- 07-293 30 cm
- Left handed.

- 07-294 16 cm
- Right handed.
- 07-295 20 cm
- Right handed.
- 07-296 16 cm
- Left handed.
- 07-297 20 cm
- Left handed.

Finochietto Needle Holders T.C

Finochietto Needle Holders T.C

Mayo-Hegar Needle Holders T.C
Also Available Right Handle

Nadelhalter
Prote-aiguilles

Porta-agujas
Porta aghi



07-298
20 cm
Curved

Finochietto Needle Holders T.C



07-299
18 cm

Rochester Needle Holders T.C



07-300
20 cm
07-301
23 cm
07-302
25 cm
Curved

07-303
20 cm
07-304
23 cm
07-305
25 cm
Curved

Stratte Needle Holders T.C



07-306
16 cm

Gillies Needle Holders T.C



07-307
12.5 cm
Smooth

07-308
12.5 cm
Serrated-Solid

07-309
12.5 cm
Tungsten
Carbide
Smooth

07-310
12.5 cm
Tungsten
Carbide
Serrated-Solid



Halsey Needle Holders T.C



07-311
14 cm
Serrated-Delicate

Eufrate Pasque T.C
Needle Holders



- | | |
|---|---|
|  |  |
| 07-312
12.5 cm | 07-317
12.5 cm |
| 07-313
15 cm | 07-318
15 cm |
| 07-314
18 cm | 07-319
18 cm |
| 07-315
20 cm | 07-320
20 cm |
| 07-316
23 cm | 07-321
23 cm |
- Smooth inserts.

Ryder Needle Holders T.C
Narrow jaws.

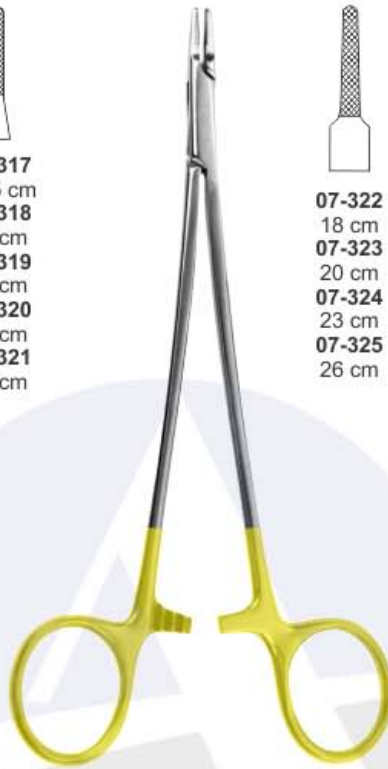

- | |
|---|
|  |
| 07-322
18 cm |
| 07-323
20 cm |
| 07-324
23 cm |
| 07-325
26 cm |



Cooley Intracardiac Needle Holders T.C
Narrow Jaw.



- | |
|---|
|  |
| 07-326
15 cm
Serrated-Solid |
|  |
| 07-327
15 cm
Serrated-Solid |

Baby Crile-Wood Needle Holders T.C



- | | |
|---|---|
|  |  |
| 07-328
13 cm | 07-334
13 cm |
| 07-329
15 cm | 07-335
16 cm |
| 07-330
18 cm | 07-336
18 cm |
| 07-331
20 cm | 07-337
20 cm |
| 07-332
23 cm | 07-338
23 cm |
| 07-333
26 cm
Serrated-Solid | Serrated-Micro |

Ryder French-Eye/Standard/Micro Needle Holders T.C



- | |
|---|
|  |
| 07-339
12.5 cm
Tungsten Carbide
Serrated-Solid |

Converse Needle Holders



- | |
|---|
|  |
| 07-340
12 cm
Tungsten Carbide
Serrated-Solid |

Derf Needle Holders T.C

Nadelhalter
Prote-aiguilles

Porta-agujas
Porta aghi



De Bakey Needle Holders T.C
07-341 18 cm
07-342 20 cm
07-343 22 cm
07-344 25 cm



Debakey Cardiovascular Needle Holders T.C
Delicate patterns.
serrated.



Debakey-Vascular/Extra Light Needle Holders T.C

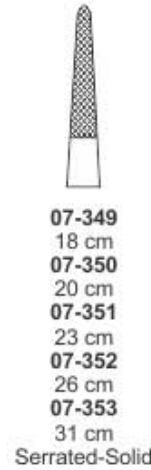

07-345 18 cm
07-346 23 cm
07-347 26 cm
07-348 30 cm
07-349 18 cm
07-350 20 cm
07-351 23 cm
07-352 26 cm
07-353 31 cm
Serrated-Solid



Gillies Slim T.c Needle Holders with Scissors



07-354
15cm



Wire Twisters Needle Holders T.C



07-355 15 cm
Delicate.
07-356 15 cm
07-357 18 cm
07-358 20 cm
Heavy



Sternum Needle Holders T.C



07-359 18 cm
Wire Twister



Cooley-Baumgaften Wire Twister Needle Holders T.C
Extra heavy needle holder designed for twisting of wire and placement of retention suture. Heavy, blunt jaws.

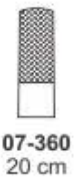

07-360
20 cm

Nadelhalter
Prote-aiguilles

Porta-agujas
Porta aghi



07-361
12.5 cm

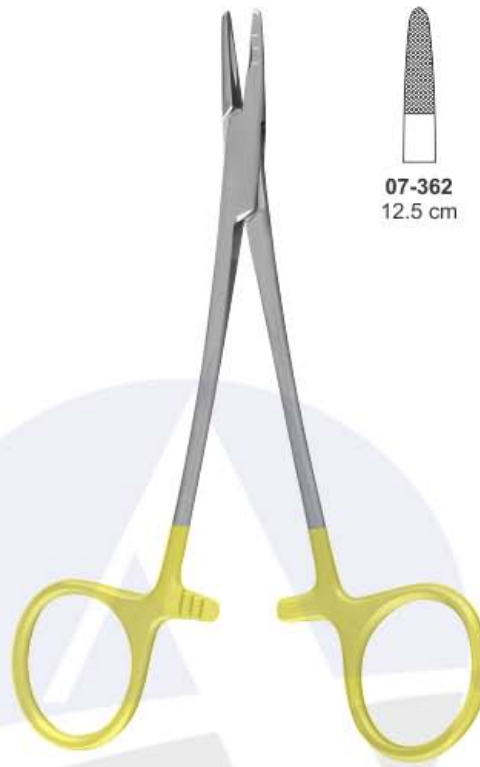

07-362
12.5 cm

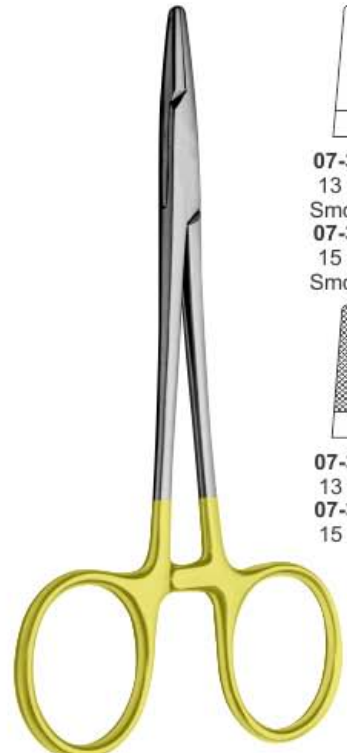

07-363
13 cm
Smooth
07-364
15 cm
Smooth
07-365
13 cm
07-366
15 cm

**Rubio Wire Twister
Needle Holders T.C**

Neivert Needle Holders T.C

Webster Needle Holders T.C

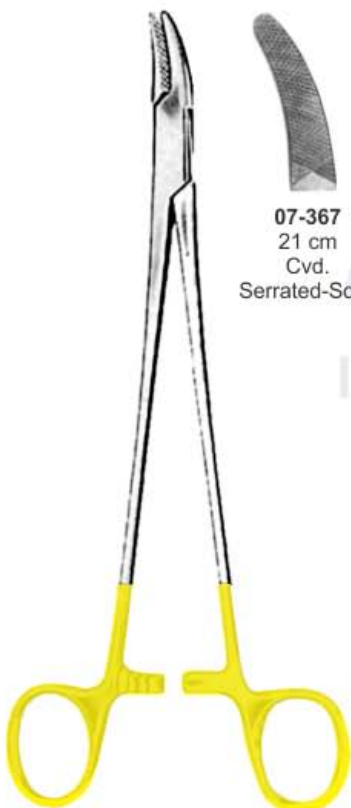

07-367
21 cm
Cvd.
Serrated-Solid
07-368
24 cm
Cvd.
Tungsten
Carbide
Serrated-Solid

07-369
26 cm
Cvd.
Tungsten
Carbide
Serrated-Solid



**Wire Tightening
Needle Holders T.C**
07-370 18 cm



07-371
20 cm
Straight
07-372
20 cm
Curved

Julian Needle Holders T.C

Nadelhalter
Prote-aguilles

Porta-agujas
Porta aghi



07-373
27 cm

07-374
30 cm

07-375
15 cm
07-376
17 cm
07-377
20 cm

07-378
20 cm
07-379
25 cm

Masson Needle Holders T.C **O'Brien Needle Holders T.C**

Martin
Needle Holder mini profile elastic type

Thomson-Walker
Needle Holders T.C



07-382
18 cm
07-383
22 cm

07-384
14 cm
Straight

07-385
14 cm
Curved

Hepp-Scheidel
07-380
Micro Needle Holder smooth jaw
18 cm,

Lichtenberg
07-381 20 cm
Needle Holder lightweight model
standard profile

Castroviejo Needle
Holders T.C

Castroviejo Needle
Holders T.C

Nadelhalter
Prote-aiguilles

Porta-agujas
Porta aghi



07-386
18 cm
Smooth



07-387
21 cm
Smooth



07-388
21 cm
Smooth



07-389
21 cm
Serrated-Solid

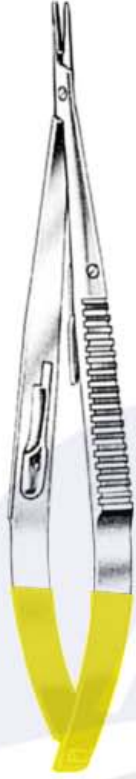

07-390
14 cm
Straight
Smooth
fine tip



07-391
14 cm
Curved
Smooth
fine tip



07-392
14 cm
Straight
Serrated-Solid
fine tip



07-393
14 cm
Straight
Smooth
regular tip



07-394
14 cm
07-395
18 cm
Straight
Serrated-Solid
fine tip



07-396
14 cm
07-397
18 cm
Curved
Serrated-Solid
fine tip



Micro Needle Holder
07-398 15 cm
07-399 18 cm
07-400 21 cm
07-401 23 cm

Jacobson
Needle Holders T.C

Castroviejo
Needle Holders T.C



Toennis Needle Holders T.C
07-402 18.5 cm



Boynton Needle Holders T.C
07-403 12 cm



Arruga Needle Holders T.C
07-404 16 cm Str.
07-405 16 cm Cvd.



Spencer Coronary
Needle Holders T.C
07-406 18 cm



Jaboma
07-407
Micro Needle Holder
18 cm

Nadelhalter
Prote-aiguilles

Porta-agujas
Porta aghi



Castroviejo Micro Needle Holder
07-408 14.5 cm
07-409 18 cm
07-410 21.5 cm



Barraquer
07-411
Micro Needle Holder
13 cm



Barraquer
07-412
Micro Needle Holder
13 cm



Mathieu Needle Holder
07-413 14 cm
07-414 17 cm
07-415 20 cm



Mathieu Needle Holder
07-416 14 cm
07-417 17 cm
07-418 20 cm



Mathieu Needle Holder
07-419 17 cm
07-420 20 cm
07-421 23 cm
standard profile with interior ratchet



Castroviejo
07-422
Micro Needle Holder
12.5 cm



Kalt Needle Holders T.C
07-423 14 cm Str.



Mathieu-Ryder Needle Holders T.C



Mathieu-Ryder Vascular Needle Holders T.C

07-424 17 cm
07-425 20 cm
07-426 24 cm

07-427 17 cm
07-428 20 cm
07-429 24 cm

Nadelhalter
Prote-aiguilles

Porta-agujas
Porta aghi

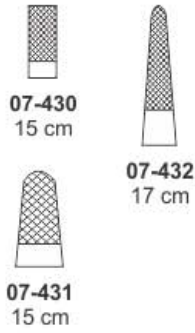

Corwin Needle Holders T.C



Lichtenberg Needle Holders T.C

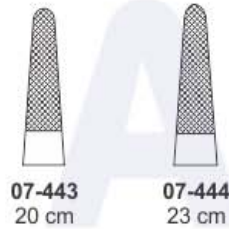
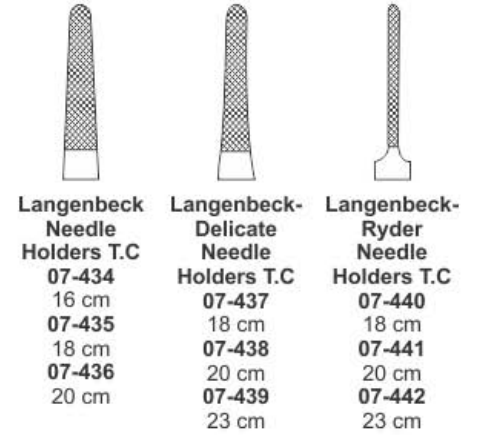

Zweifel Needle Holders T.C



Eiselsberg-Matheiu
Needle Holders T.C



Luethy-Beck
Needle Holders T.C

Reverdin nadeln
aguja de reverdin

Aguilles de reverdin
aghi di reverdin

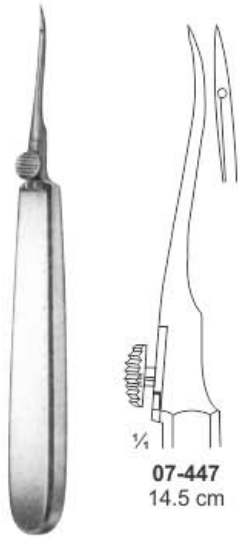

07-447
14.5 cm



07-448
14.5 cm



07-449
14.5cm

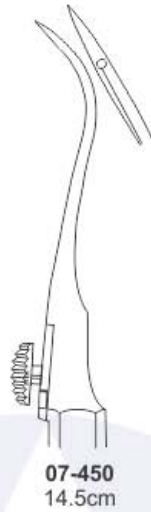

07-450
14.5cm



21cm



2
07-451



1
07-452



4
07-453



3
07-454

Reverdin Needle
short



Reverdin Needle
19.5 cm



07-455
19.5cm



07-457
19.5cm



07-459
19.5cm



07-461
19.5cm



Reverdin Needle
23 cm

07-456
23cm

07-458
23cm

07-460
23cm

07-462
23cm



07-463
25cm



07-464
23cm



07-465
28cm



König
07-466
20 cm



Payr
07-467
22 cm



König Ligature
Conductor



Michel
07-469

Reverdin nadeln
agujas de reverdin

Aguilles de reverdin
aghi di reverdin

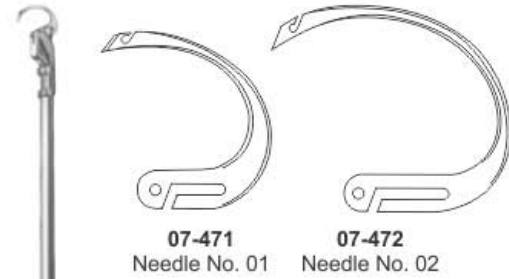

07-471
Needle No. 01

07-472
Needle No. 02

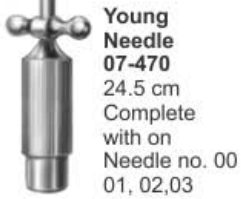

Young Needle 07-470
24.5 cm
Complete with on Needle no. 00 01, 02, 03



07-473
Needle No. 03



Schmieden-Dick Needle 07-474
29cm malleable



Schmieden Needle 07-475
24cm



Ligature Needle 07-476
20 cm

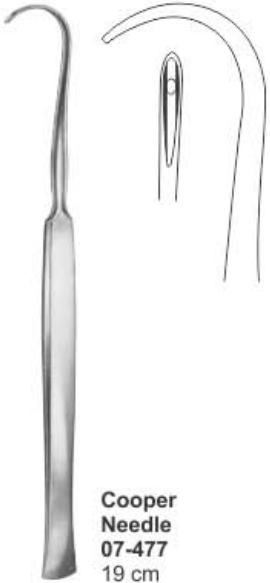

Cooper Needle 07-477
19 cm



Kronecker Needle 07-478
13 cm delicate for right hand



Kronecker Needle 07-479
13 cm delicate for left hand



Curved to left, for the right hand

Deschamps Needle 07-480
24 cm

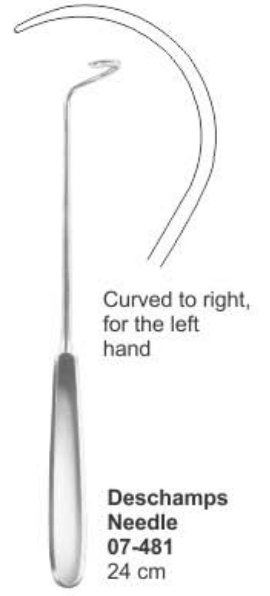

Curved to right, for the left hand

Deschamps Needle 07-481
24 cm



07-482
20cm sharp for right hand

Deschamps Needle



07-483
20cm sharp for left hand

07-484
27cm blunt for right hand

Deschamps Needle



07-485
27cm blunt for left hand



07-486
27cm sharp for right hand

Deschamps Needle



07-487
27cm sharp for left hand



07-488
28cm blunt for right hand

Deschamps Needle



07-489
28cm blunt for left hand

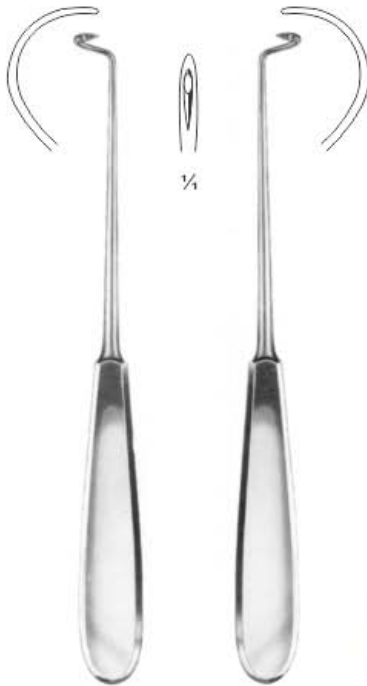

Deschamps Needle
07-490 **07-491**
 20cm 20cm
 sharp sharp
 for right hand for left hand



Deschamps Needle
07-492 **07-493**
 20cm 20cm
 blunt blunt
 for right hand for left hand



Deschamps Needle
07-494 **07-495**
 21cm 21cm
 blunt blunt
 for right hand for left hand



Deschamps Needle
07-496 **07-497**
 20cm 20cm
 blunt blunt
 for right hand for left hand



Deschamps Needle
07-498 **07-499**
 20cm 20cm
 sharp sharp
 for right hand for left hand



Deschamps Needle
07-500 **07-501**
 20cm 20cm
 blunt blunt
 for right hand for left hand

Reverdin nadeln
aguja de reverdin

Aguilles de reverdin
aghi di reverdin

SURGEONS NEEDLES

- 07-502 Fistula Needle, 1/2 Circle, Cutting Edge, #00
- 07-503 Fistula Needle, 1/2 Circle, Cutting Edge, #0
- 07-504 Fistula Needle, 1/2 Circle, Cutting Edge, #1
- 07-505 Fistula Needle, 1/2 Circle, Cutting Edge, #2
- 07-506 Fistula Needle, 1/2 Circle, Cutting Edge, #3
- 07-507 Fistula Needle, 1/2 Circle, Cutting Edge, #4
- 07-508 Fistula Needle, 1/2 Circle, Cutting Edge, #5
- 07-509 Fistula Needle, 1/2 Circle, Cutting Edge, #6
- 07-510 Fistula Needle, 1/2 Circle, Cutting Edge, #7
- 07-511 Fistula Needle, 1/2 Circle, Cutting Edge, #8
- 07-512 Fistula Needle, 1/2 Circle, Cutting Edge, #9

- 07-513 Regular Surgeons Needle, 1/2 Circle, Cutting Edge, #0
- 07-514 Regular Surgeons Needle, 1/2 Circle, Cutting Edge, #1
- 07-515 Regular Surgeons Needle, 1/2 Circle, Cutting Edge, #2
- 07-516 Regular Surgeons Needle, 1/2 Circle, Cutting Edge, #3
- 07-517 Regular Surgeons Needle, 1/2 Circle, Cutting Edge, #4
- 07-518 Regular Surgeons Needle, 1/2 Circle, Cutting Edge, #5
- 07-519 Regular Surgeons Needle, 1/2 Circle, Cutting Edge, #6
- 07-520 Regular Surgeons Needle, 1/2 Circle, Cutting Edge, #7
- 07-521 Regular Surgeons Needle, 1/2 Circle, Cutting Edge, #8
- 07-522 Regular Surgeons Needle, 1/2 Circle, Cutting Edge, #9
- 07-523 Regular Surgeons Needle, 1/2 Circle, Cutting Edge, #10
- 07-524 Regular Surgeons Needle, 1/2 Circle, Cutting Edge, #11
- 07-525 Regular Surgeons Needle, 1/2 Circle, Cutting Edge, #12
- 07-526 Regular Surgeons Needle, 1/2 Circle, Cutting Edge, #13
- 07-527 Regular Surgeons Needle, 1/2 Circle, Cutting Edge, #14
- 07-528 Regular Surgeons Needle, 1/2 Circle, Cutting Edge, #15
- 07-529 Regular Surgeons Needle, 1/2 Circle, Cutting Edge, #16
- 07-530 Regular Surgeons Needle, 1/2 Circle, Cutting Edge, #17
- 07-531 Regular Surgeons Needle, 1/2 Circle, Cutting Edge, #18
- 07-532 Regular Surgeons Needle, 1/2 Circle, Cutting Edge, #19
- 07-533 Regular Surgeons Needle, 1/2 Circle, Cutting Edge, #20

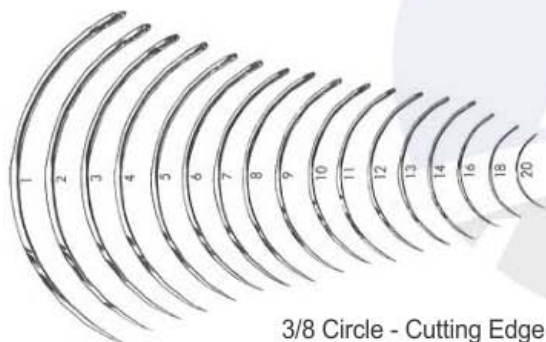

3/8 Circle - Cutting Edge

SURGEONS NEEDLES

- 07-534 Regular Surgeons Needle, 3/8 Circle, Cutting Edge, #1
- 07-535 Regular Surgeons Needle, 3/8 Circle, Cutting Edge, #2
- 07-536 Regular Surgeons Needle, 3/8 Circle, Cutting Edge, #3
- 07-537 Regular Surgeons Needle, 3/8 Circle, Cutting Edge, #4
- 07-538 Regular Surgeons Needle, 3/8 Circle, Cutting Edge, #5
- 07-539 Regular Surgeons Needle, 3/8 Circle, Cutting Edge, #6
- 07-540 Regular Surgeons Needle, 3/8 Circle, Cutting Edge, #7
- 07-541 Regular Surgeons Needle, 3/8 Circle, Cutting Edge, #8
- 07-542 Regular Surgeons Needle, 3/8 Circle, Cutting Edge, #9
- 07-543 Regular Surgeons Needle, 3/8 Circle, Cutting Edge, #10
- 07-544 Regular Surgeons Needle, 3/8 Circle, Cutting Edge, #11
- 07-545 Regular Surgeons Needle, 3/8 Circle, Cutting Edge, #12
- 07-546 Regular Surgeons Needle, 3/8 Circle, Cutting Edge, #13
- 07-547 Regular Surgeons Needle, 3/8 Circle, Cutting Edge, #14
- 07-548 Regular Surgeons Needle, 3/8 Circle, Cutting Edge, #15
- 07-549 Regular Surgeons Needle, 3/8 Circle, Cutting Edge, #16
- 07-550 Regular Surgeons Needle, 3/8 Circle, Cutting Edge, #17
- 07-551 Regular Surgeons Needle, 3/8 Circle, Cutting Edge, #18
- 07-552 Regular Surgeons Needle, 3/8 Circle, Cutting Edge, #19
- 07-553 Regular Surgeons Needle, 3/8 Circle, Cutting Edge, #20

Keith Abdominal Straight, Triangular Point

- 07-566 Keith Abdominal Needles, Straight, Triangular Point, 4"
- 07-567 Keith Abdominal Needles, Straight, Triangular Point, 3-1/2"
- 07-568 Keith Abdominal Needles, Straight, Triangular Point, 3"
- 07-569 Keith Abdominal Needles, Straight, Triangular Point, 2-7/8"
- 07-570 Keith Abdominal Needles, Straight, Triangular Point, 2-1/8"
- 07-571 Keith Abdominal Needles, Straight, Triangular Point, 2"
- 07-572 Keith Abdominal Needles, Straight, Triangular Point, 1-3/4"
- 07-573 Keith Abdominal Needles, Straight, Triangular Point, 1-1/2"

SURGEONS NEEDLES

- 07-554 Regular Surgeons Needles, 1/2 Curved, Cutting Edge, #0
- 07-555 Regular Surgeons Needles, 1/2 Curved, Cutting Edge, #1
- 07-556 Regular Surgeons Needles, 1/2 Curved, Cutting Edge, #2
- 07-557 Regular Surgeons Needles, 1/2 Curved, Cutting Edge, #4
- 07-558 Regular Surgeons Needles, 1/2 Curved, Cutting Edge, #6
- 07-559 Regular Surgeons Needles, 1/2 Curved, Cutting Edge, #8
- 07-560 Regular Surgeons Needles, 1/2 Curved, Cutting Edge, #10
- 07-561 Regular Surgeons Needles, 1/2 Curved, Cutting Edge, #12
- 07-562 Regular Surgeons Needles, 1/2 Curved, Cutting Edge, #14
- 07-563 Regular Surgeons Needles, 1/2 Curved, Cutting Edge, #16
- 07-564 Regular Surgeons Needles, 1/2 Curved, Cutting Edge, #20
- 07-565 Regular Surgeons Needles, 1/2 Curved, Cutting Edge, #22

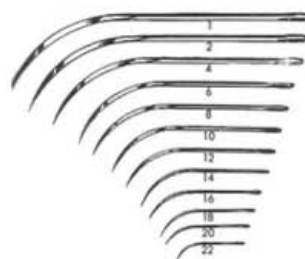

half Curved - Cutting Edge

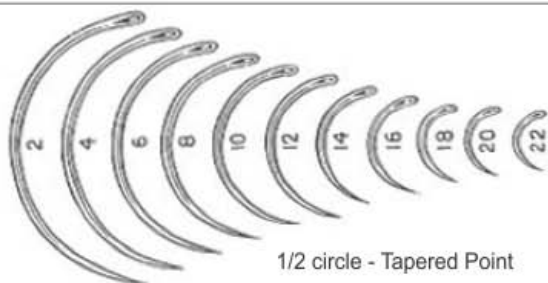

1/2 circle - Tapered Point

- 07-574 Regular Surgeons Needles, 1/2 Curved, Tapered Point, #2
- 07-575 Regular Surgeons Needles, 1/2 Curved, Tapered Point, #4
- 07-576 Regular Surgeons Needles, 1/2 Curved, Tapered Point, #6
- 07-577 Regular Surgeons Needles, 1/2 Curved, Tapered Point, #8
- 07-578 Regular Surgeons Needles, 1/2 Curved, Tapered Point, #10
- 07-579 Regular Surgeons Needles, 1/2 Curved, Tapered Point, #12
- 07-580 Regular Surgeons Needles, 1/2 Curved, Tapered Point, #14
- 07-581 Regular Surgeons Needles, 1/2 Curved, Tapered Point, #16
- 07-582 Regular Surgeons Needles, 1/2 Curved, Tapered Point, #18
- 07-583 Regular Surgeons Needles, 1/2 Curved, Tapered Point, #20
- 07-584 Regular Surgeons Needles, 1/2 Curved, Tapered Point, #22



3/8 circle - cutting edge

- SURGEONS NEEDLES**
- A 07-585 Veterinary Needles, 3/8 Circle, Cutting Edge, #1
 - 07-586 Veterinary Needles, 3/8 Circle, Cutting Edge, #2
 - 07-587 Veterinary Needles, 3/8 Circle, Cutting Edge, #3
 - 07-588 Veterinary Needles, 3/8 Circle, Cutting Edge, #4
 - 07-589 Veterinary Needles, 3/8 Circle, Cutting Edge, #5
 - 07-590 Veterinary Needles, 3/8 Circle, Cutting Edge, #6
 - 07-591 Veterinary Needles, 3/8 Circle, Cutting Edge, #7
 - 07-592 Veterinary Needles, 3/8 Circle, Cutting Edge, #8



double curved - cutting edge

- B 07-593 Post Mortem Needles, Double Curve Cutting Edge, Size 1
- 07-594 Post Mortem Needles, Double Curve Cutting Edge, Size 2
- 07-595 Post Mortem Needles, Double Curve Cutting Edge, Size 3
- 07-596 Post Mortem Needles, Double Curve Cutting Edge, Size 4
- 07-597 Post Mortem Needles, Double Curve Cutting Edge, Size 5
- 07-598 Post Mortem Needles, Double Curve Cutting Edge, Size 6
- 07-599 Post Mortem Needles, Double Curve Cutting Edge, Size 7
- 07-600 Post Mortem Needles, Double Curve Cutting Edge, Size 8

SURGEONS NEEDLES

- A 07-601 Martin Uterine Needles, 1/2 Curved Cutting Edge, #1
- 07-602 Martin Uterine Needles, 1/2 Curved Cutting Edge, #2
- 07-603 Martin Uterine Needles, 1/2 Curved Cutting Edge, #3
- 07-604 Martin Uterine Needles, 1/2 Curved Cutting Edge, #4
- 07-605 Martin Uterine Needles, 1/2 Curved Cutting Edge, #5
- 07-606 Martin Uterine Needles, 1/2 Curved Cutting Edge, #6
- 07-607 Martin Uterine Needles, 1/2 Curved Cutting Edge, #7
- 07-608 Martin Uterine Needles, 1/2 Curved Cutting Edge, #8
- B 07-609 Lane Cleft Palate, 1/2 Circle, Cutting Edge, #1
- 07-610 Lane Cleft Palate, 1/2 Circle, Cutting Edge, #2
- 07-611 Lane Cleft Palate, 1/2 Circle, Cutting Edge, #3
- 07-612 Lane Cleft Palate, 1/2 Circle, Cutting Edge, #4
- 07-613 Lane Cleft Palate, 1/2 Circle, Cutting Edge, #5
- C 07-614 Post Mortem Needles, Half Curved Cutting Edge, Size 1
- 07-615 Post Mortem Needles, Half Curved Cutting Edge, Size 2
- 07-616 Post Mortem Needles, Half Curved Cutting Edge, Size 3
- 07-617 Post Mortem Needles, Half Curved Cutting Edge, Size 4
- 07-618 Post Mortem Needles, Half Curved Cutting Edge, Size 5
- 07-619 Post Mortem Needles, Half Curved Cutting Edge, Size 6



Martin, 1/2 Circle Cutting Edge

A



Left Cleft Palate, 1/2 Circle Cutting Edge

B

Post Mortem - Half Curved Cutting Edge

C

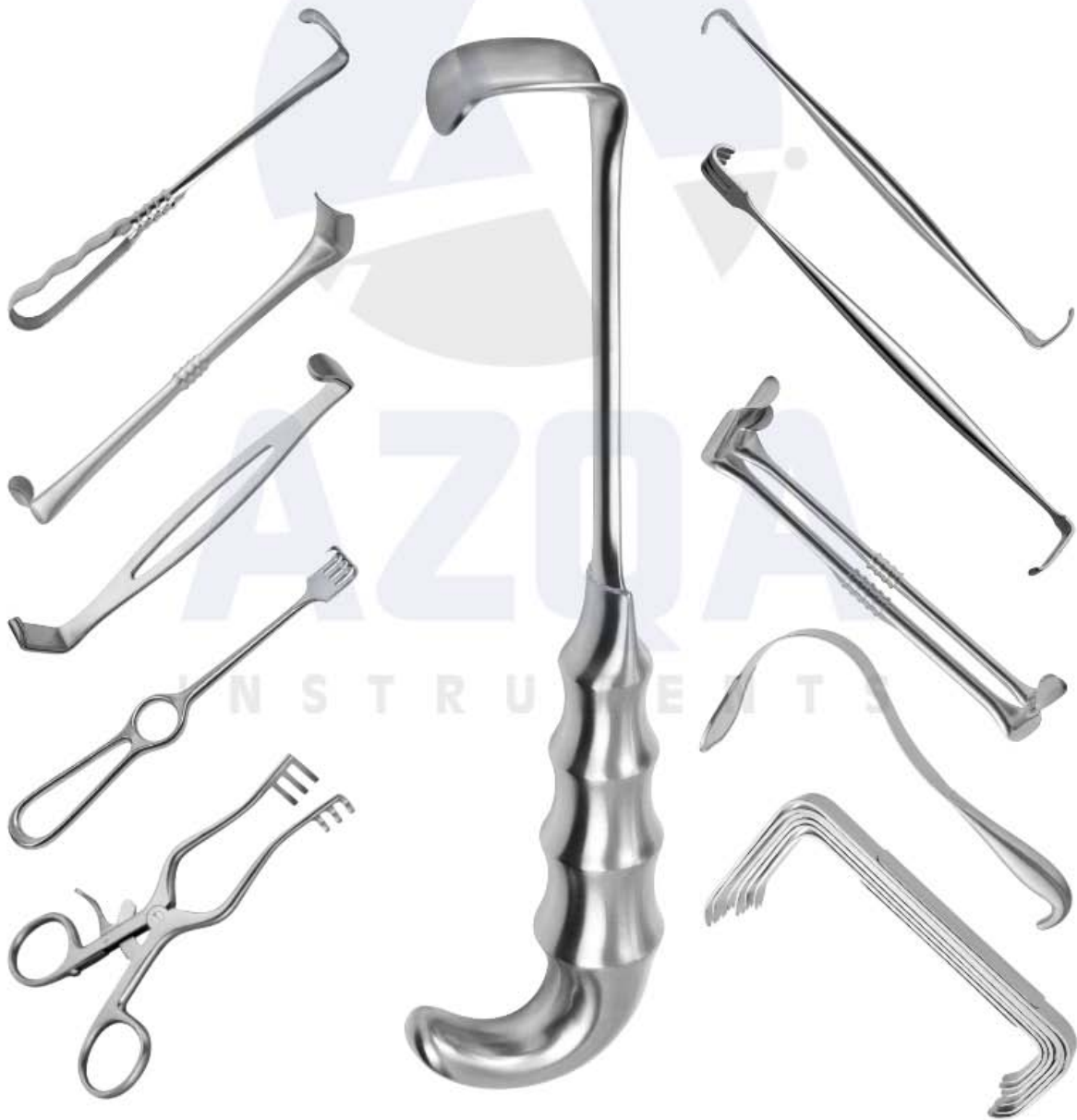
RETRACTORS INSTRUMENTS



Wundhäkchen, Mikrohäkchen
Ganchito, Micro Ganchitos

Crochet, Micro crochetes
Divaricatore, Micro Divaricatori

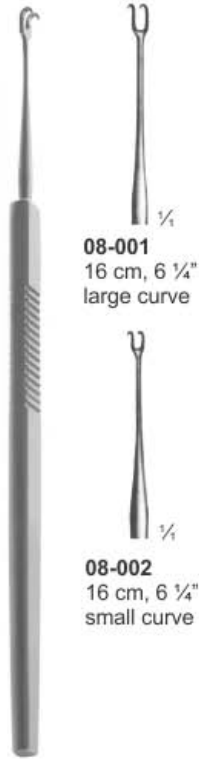

08-001
16 cm, 6 1/4"
large curve

08-002
16 cm, 6 1/4"
small curve

GUTHRIE HOOKLET



08-003
18 cm, 7"
Sharp

08-004
18 cm, 7"
sharp

GILLIES SKIN HOOK



08-005
15 cm, 6"
sharp

KILNER HOOK



08-006
18.5 cm, 7 1/4"
sharp

08-007
18.5 cm, 7 1/4"
sharp

FISCH HOOKLET & Skin Hook

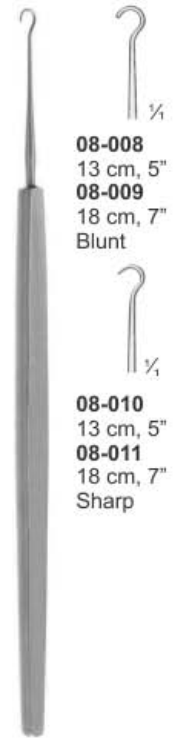

08-008
13 cm, 5"
08-009
18 cm, 7"
Blunt

08-010
13 cm, 5"
08-011
18 cm, 7"
Sharp

FRAZIER HOOKLET & Skin Hook



DOUBLE PRONG MICRO HOOK & Skin Hook
08-012
Sharp, 2mm, wide jaws,
14.5 cm, 6 3/4"



WIENER HOOK & Skin Hook
08-013
Sharp,
14 cm, 5 1/2"



TOENNIS HOOK & Skin Hook
08-014
Sharp
15 cm, 6"



08-015
2 sharp prong
13 cm, 5"
2.25mm diameter
3mm wide

08-016
4 sharp prong
13 cm, 5"
2mm diameter
5mm wide

08-017
4 blunt prong
13 cm, 5"
2mm diameter
5mm wide

ROLLET HOOK



08-018
15 cm, 6", sharp
double prongs
2.5mm wide

08-019
15 cm, 6", blunt
double prongs
2.5mm wide

FREER SKIN HOOK



CRILE HOOKLET & SKIN HOOKS
08-020 20.4 cm, 8"



VON GRAEFE Strabismus & SKIN HOOKS
08-021 13.0 cm, 5" - A
08-022 14.0 cm, 5 1/2" - B
08-023 15.0 cm, 6" - C



WAGENER HOOKLET & SKIN HOOKS
08-024 14 cm, 5 1/2" - A
08-025 14 cm, 5 1/2" - B
08-026 14 cm, 5 1/2" - C
08-027 14 cm, 5 1/2" - D



DAY HOOKLET & SKIN HOOKS
08-028 16 cm, 6 1/4" - A
08-029 16 cm, 6 1/4" - B

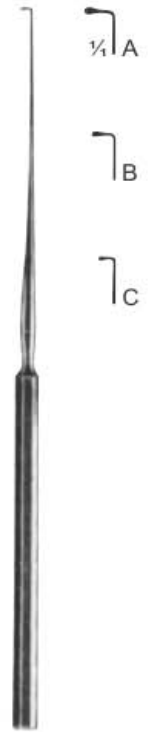

LUCAE HOOKLET & SKIN HOOKS
08-030 14 cm, 5 1/2" - A
08-031 14 cm, 5 1/2" - B
08-032 14 cm, 5 1/2" - C



Converse Hook
08-033
12 cm, 5"



MANNERFELT-LANGENBECK HOOK
08-034 15 x 6 mm 15.5 cm, 6" Fig.1
08-035 20 x 6 mm 15.5 cm, 6" Fig.2
08-036 25 x 6 mm 15.5 cm, 6" Fig.3
08-037 30 x 8 mm 15.5 cm, 6" Fig.4



MANNERFELT HOOK
15.5 cm, 6"
large curve, single
hook



08-038
Sharp

08-039
2 prong
Blunt

08-040
3 prong
Blunt



Brom Hooklet Retractors
08-041
17 cm, 6 3/4"



Hooklet Retractors
08-042
13 cm, 5"



Tracheal Retractor
18 cm



Tracheal Retractor
18 cm

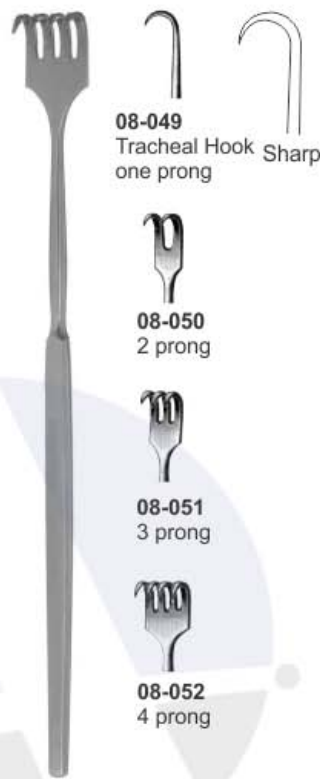

Trachea Retractor
16.5 cm Sharp

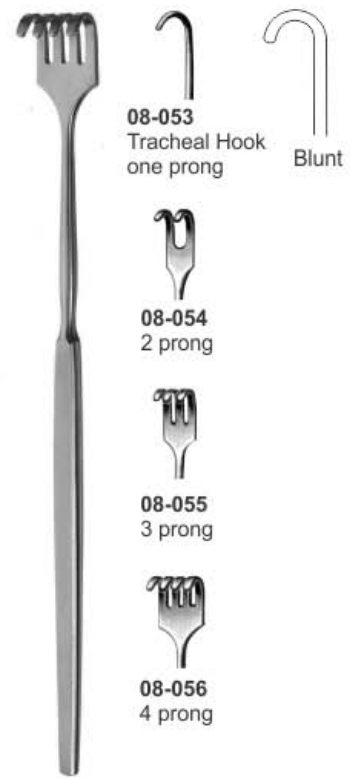

Tracheal Retractor
16.5 cm Blunt



**Rollet Hooklet
Retractors**
08-057
12.5cm

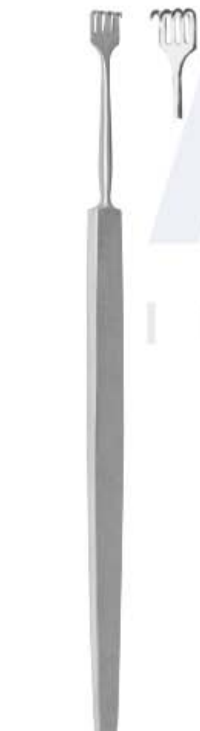

**Rollet (Blair)
Hooklet Retractors**
08-058
13.5cm



**Paul Hooklet
Retractors**
08-059
12.5cm



**Paul Hooklet
Retractors**
08-060
16cm



Miller Retractor
08-061
13.5cm
Sharp 6 prong



Miller Retractor
13.5 cm

Wundhäkchen, Wundhaken
Ganchito, Separadores

Crochet, Ecarteurs
Divaricatore, Divaricatori

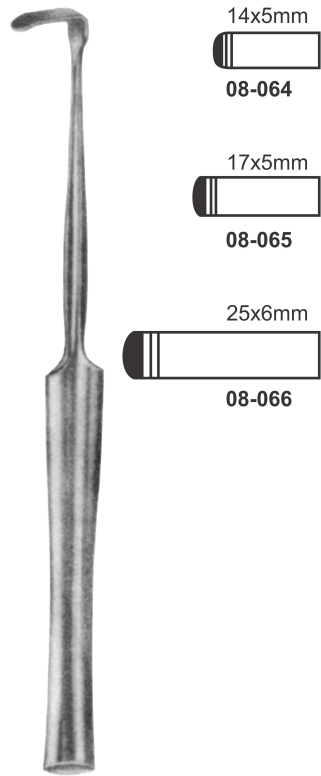

Hooklet Retractors
17 cm

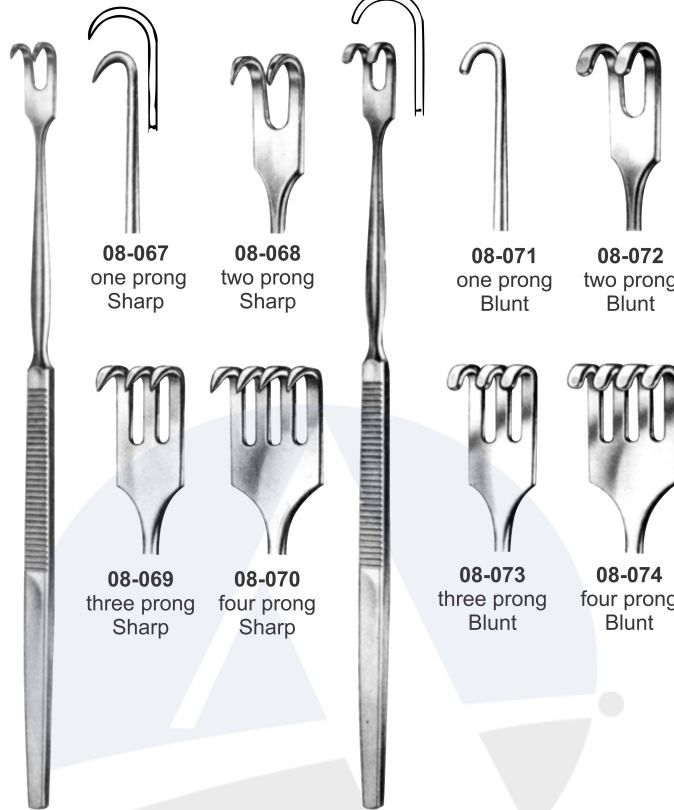

Finger Rake, Retractor
16.5 cm

Finger Rake, Retractor
16.5 cm

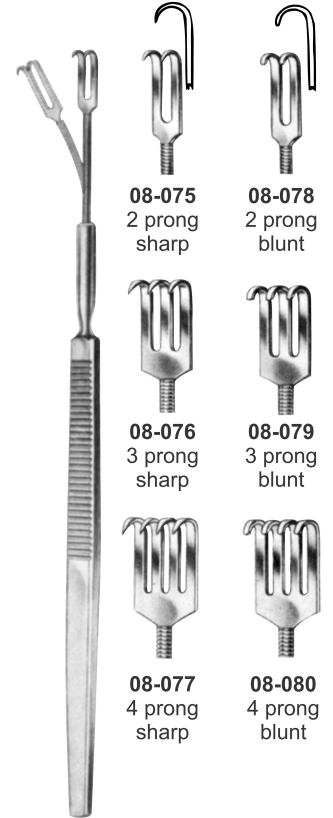

Hooklets, Retractors
flexible,
16 cm

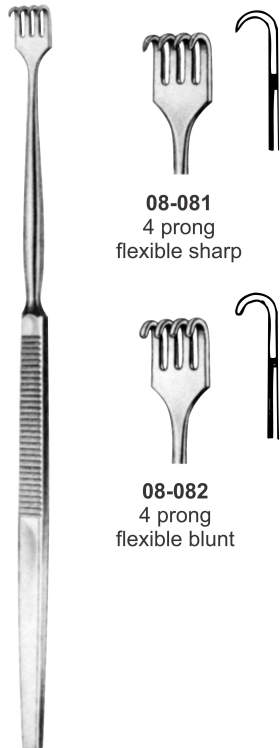

Peck Rake Retractor
16.5 cm



Kocher Hooklet, Retractors



Kocher Hooklet, Retractors

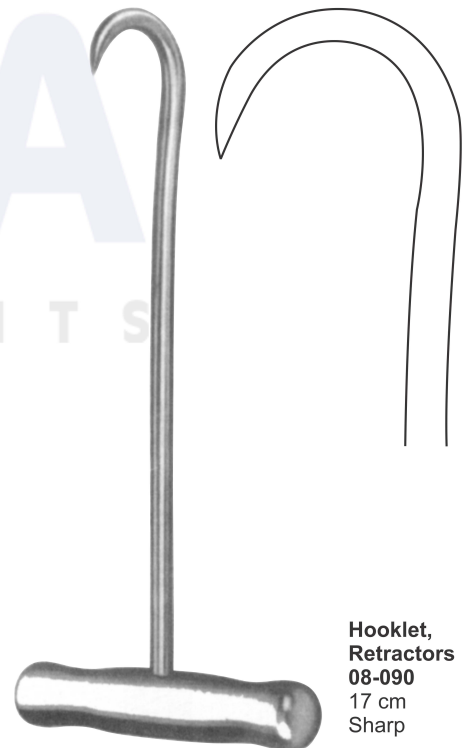

Hooklet, Retractors
08-090
17 cm
Sharp

Wundhäkchen, Wundhaken
Ganchito, Separadores

Crochet, Ecarteurs
Divaricatore, Divaricatori



Volkman Retractors
08-091 23 cm
Sharp



Volkman Retractors
08-092 23 cm
Blunt



Lambotte Retractors
20 cm

08-093
13 x 235 mm
08-094
20 x 255 mm
08-095
27 x 270 mm



Volkman Retractors
11.5 cm



08-096
2 prong



08-100
2 prong



08-097
3 prong



08-101
3 prong



08-098
4 prong



08-102
4 prong



08-099
6 prong



08-103
6 prong



Murphy Retractors
19.1 cm 7 1/2"

08-104
3 prongs
08-105
3 prongs
08-106
4 prongs
08-107
4 prongs
Sharp



Senn Retractor
08-108
16 cm 6 1/4"
Blunt



Senn Retractor
08-109
16 cm 6 1/4"
Sharp



Senn-Mueller Retractor
08-110
18 x 6 mm
16 cm, 6 1/4"
sharp



Volkman Retractor
08-111
22 cm 8 3/4"
4 Prongs Sharp



Volkman Retractor
08-112
22 cm 8 3/4"
4 Prongs Blunt

Wundhäkchen, Wundhaken
Ganchito, Separadores

Crochet, Ecarteurs
Divaricatore, Divaricatori



Sternberg Retractor
08-113 12 cm, 4 3/4"
08-114 14 cm, 5 1/2"
08-115 16 cm, 6 1/4"



Collin-Hartmann Retractor
08-116
38 x 28 / 32 x 21 mm 14 cm, 5 1/2"
08-117
52 x 34 / 36 x 27 mm 16 cm, 6 1/4"



Herzfeld Retractor
08-118
20 cm, 8"



Strandell-Stille Retractor
08-119
19 cm, 7 1/2"



Strandell-Stille Retractor
08-120
19 cm, 7 1/2"

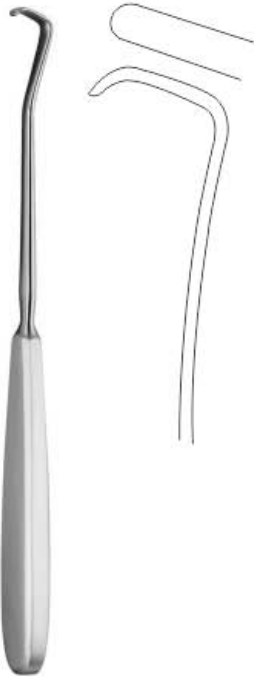

Schoenbore Retractor
08-121
21 cm, 8 1/4"



Konig Retractor
17 cm, 6 3/4"



08-122
13 x 13 mm

08-123
12 x 16 mm



Senn-Green Retractor
15 cm, 6"



08-124
10 x 6 mm

08-125
20 x 6 mm



Cottle Retractor
08-126
15 cm, 6"
10 x 12 mm



Ragnell-Davis Retractor
08-127 8 x 4 mm
08-128 15 x 5.5 mm

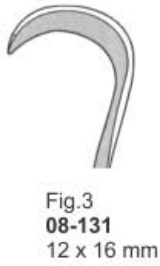

Mannerfelt Hooklet Retractors
15.5cm



Cushing Hooklet Retractors
20cm

Cushing Hooklet Retractors
24cm

Cushing-Kocher Hooklet Retractors
18 cm

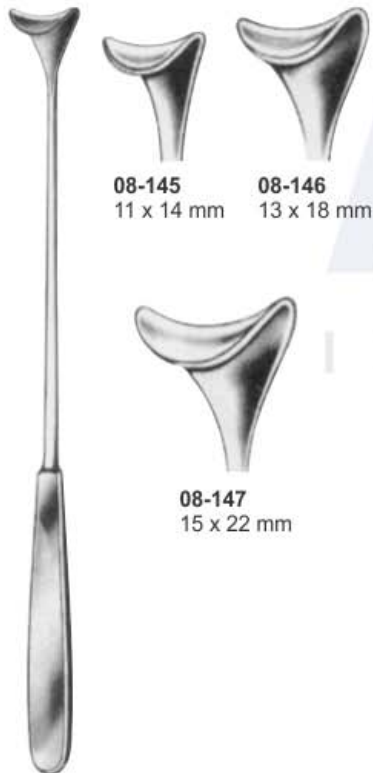

Cushing Hooklet Retractors
24cm



Desmarres Lid Retractors
16cm



Kocher Retractor



Kocher Retractor
22 cm
08-161 40 x 10 mm
08-162 40 x 15 mm
08-163 40 x 20 mm

Wundhaken | Ecarteurs
Separadores | Divaricatori

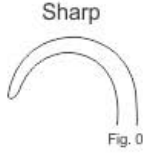

Kocher Retractor

- 08-164 22 cm, 8 3/4" 15 x 10 mm 2 prong Fig. 1
- 08-165 22 cm, 8 3/4" 15 x 15 mm 3 prong Fig. 2
- 08-166 22 cm, 8 3/4" 15 x 20 mm 4 prong Fig. 3
- 08-167 22 cm, 8 3/4" 15 x 30 mm 6 prong Fig. 4
- 08-168 22 cm, 8 3/4" 15 x 40 mm 8 prong Fig. 5

Kocher Retractor

- 08-169 22 cm, 8 3/4" 15 x 10 mm 2 prong Fig. 1
- 08-170 22 cm, 8 3/4" 15 x 15 mm 3 prong Fig. 2
- 08-171 22 cm, 8 3/4" 15 x 20 mm 4 prong Fig. 3
- 08-172 22 cm, 8 3/4" 15 x 30 mm 6 prong Fig. 4
- 08-173 22 cm, 8 3/4" 15 x 40 mm 8 prong Fig. 5

- 08-174 Blunt, 2 prongs.
- 08-175 Blunt, 3 prongs.
- 08-176 Blunt, 4 prongs.
- 08-177 Blunt, 5 prongs.
- 08-178 Blunt, 6 prongs.
- 08-179 Sharp, 2 prongs.
- 08-180 Sharp, 3 prongs.
- 08-181 Sharp, 4 prongs.
- 08-182 Sharp, 5 prongs.
- 08-183 Sharp, 6 prongs.

Volkmann Retractors
Long Pattern
22.2 cm, 8 1/4"

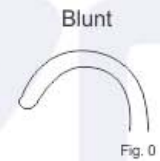
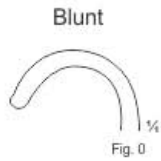

Kocher Retractor

- 08-184 22 cm, 8 3/4" 15 x 10 mm 2 prong Fig. 1
- 08-185 22 cm, 8 3/4" 15 x 15 mm 3 prong Fig. 2
- 08-186 22 cm, 8 3/4" 15 x 20 mm 4 prong Fig. 3
- 08-187 22 cm, 8 3/4" 15 x 30 mm 6 prong Fig. 4
- 08-188 22 cm, 8 3/4" 15 x 40 mm 8 prong Fig. 5

Kocher Retractor

- 08-189 22 cm, 8 3/4" 15 x 10 mm 2 prong Fig. 1
- 08-190 22 cm, 8 3/4" 15 x 15 mm 3 prong Fig. 2
- 08-191 22 cm, 8 3/4" 15 x 20 mm 4 prong Fig. 3
- 08-192 22 cm, 8 3/4" 15 x 30 mm 6 prong Fig. 4
- 08-193 22 cm, 8 3/4" 15 x 40 mm 8 prong Fig. 5

Koerte Retractor
08-195 28cm
25 x 40 mm
semi-sharp

Korte-Wagner Retractor
08-194 28cm
Sharp



Koerte Retractor
08-196 24 cm
26 x 40 mm
blunt



Koerte Retractor
08-197 24cm
26 x 40 mm
sharp



Koerte Retractor
08-198 23cm
Blunt



Koerte Retractor
08-199 23cm
46 x 55 mm
blunt



Ollier Retractor
08-200 18.5cm



Lahey Goiter Retractor
08-201 20.4cm
Right angle blade, length
1 inch. With lip.



Lahey Retractor
08-202 19cm



Tendon Hooks Retractor
08-203 12 x 6 mm Fig. 1
08-204 12 x 11 mm Fig. 2
17.5cm



Klapp Retractor
08-205 17.5cm
15 x 11 mm



Little Retractor
08-206 20cm
12x14 mm



Wassmund Retractor
08-207 20cm
33 x 20mm



Middeldorpf Retractor
08-208
14x17mm



08-209
20x22mm



08-210
26x30mm



08-211
26x30mm



Kocher Retractor
28 cm 11"



08-211



08-213



08-212



08-214



Kocher Retractor
08-215
22.5 cm 8 3/4"
70 x 25 mm



Kocher-Wagner Retractor
28 cm, 11"



08-216
22 x 15 mm



08-217
38 x 20 mm



08-218
67 x 25 mm



Kocher Retractor
23 cm, 9"

08-219
40 x 18 mm

08-220
60 x 20 mm

08-221
60 x 25 mm

08-222
75 x 30 mm

08-223
75 x 40 mm



Kocher-Langenbeck Retractor
21.5 cm, 8 1/2"

08-224
25 x 6 mm



08-225
35 x 8 mm



08-226
35 x 11 mm



08-227
35 x 15 mm



08-228
40 x 11 mm



08-229
55 x 11 mm



08-230
70 x 14 mm



08-231
80 x 12 mm



08-232
80 x 16 mm



Langenbeck Retractor
24 cm, 8 1/4"



08-233
35 x 7mm



08-234
35 x 15mm



08-235
35 x 11mm



08-236
35 x 20mm



Langenbeck Retractor 08-237
21.5 cm 8 1/2"
Handle vertical to the blade



Langenbeck Retractor 08-238
21 cm 8 1/4"
38 x 9mm



08-239
40 x 12 mm
08-240
55 x 14 mm

Caspar Retractor
21 cm, 8 1/4"



Langenbeck Retractor
20.4 cm, 8"



08-241
20 x 7 mm



08-242
30 x 7 mm



08-243
30 x 11 mm



08-244
30 x 15 mm



08-245
30 x 20 mm

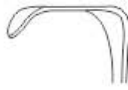

08-246
44 x 10 mm



08-247
44 x 15 mm



08-248
45 x 20 mm



08-249
50 x 20 mm



08-250
60 x 20 mm



Meyering Finger Retractor
18 cm, 7"



08-251
long blunt blade,
6 x 17 mm



08-254
long toothed blade,
5 x 16mm



08-252
short toothed blade,
3 x 6 mm



08-255
short blunt blade,
3 x 10mm



08-253
curved blunt blade,
3 x 8mm
Saddle Shaped



08-256
curved three prong
sharp blade,
10 x 4mm



Langenbeck Retractor
22 cm, 8 1/2"



08-257
25 x 6 mm



08-260
35 x 15 mm



08-264
25 x 6 mm



08-267
35 x 15 mm



08-258
35 x 8 mm



08-261
41 x 11 mm



08-265
35 x 8 mm



08-268
41 x 11 mm



08-259
35 x 11 mm



08-262
55 x 11 mm



08-266
35 x 11 mm



08-269
55 x 11 mm



08-263
70 x 14 mm



Langenbeck Retractor
22 cm, 8 1/2"



08-270
70 x 14 mm



Blount Knee Retractor
08-271 17.5 cm, 6 3/4"
 42 x 4 mm



Taylor Spinal Retractors
08-272 16.5 cm, 6 1/2"
 75 x 30 mm / 100 x 30 mm



Luer Retractor
08-273 11 cm, 4 1/4"
 10 x 8 mm / 12 x 11 mm



Rose Retractor
08-274 13 cm, 5"
 12 x 12 mm /
 12 x 15 mm



20 x 6 mm

12 x 4 mm

Crile Retractor
08-275 11 cm, 4 1/4"
 12 x 4 mm /
 20 x 6 mm



Mathieu Retractor
 Set 2 pcs.
08-276 20 cm, 8"
 47 x 13 / 46 x 26 mm
08-277 20 cm, 8"
 42 x 13 / 42 x 26 mm



Us-Army Retractor
 Set 2 pcs.
08-278 21.5 cm, 8 1/2"
 28 x 15 / 42 x 15 mm
08-279 21.5 cm, 8 1/2"
 25 x 15 / 38 x 15 mm



Richardson Eastman Retractor
08-280 26 cm, 10 1/4"
 small



Richardson Eastman Retractor
08-281 28 cm, 11"

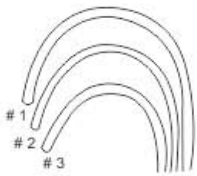

Sofield Retractor
08-282
 set of 6 pec.

Roux Retractor

Set 3 pcs. consisting of

- 08-283** 14 cm, 5 1/2" 24 x 20 / 30 x 28 mm
- 08-284** 15 cm, 6" 29 x 26 / 36 x 36 mm
- 08-285** 17 cm, 6 3/4" 33 x 29 / 38 x 43 mm

Baby-Roux Retractor

- 08-286** 13 cm, 5" 15 x 15 mm / 18 x 21 mm

Roux Retractor

- 08-287** 16.5 cm, 6 1/2" 28 x 23 mm / 43 x 23 mm

Roux Retractor

- 08-288** 18.5 cm, 7 1/4" 28 x 27 mm / 45 x 27 mm

Mini-Roux Retractor

- 08-289** 14 cm, 5 1/2"

Roux-Magnus Retractor

- 08-290** 15 cm, 6" 20 x 22 mm / 25 x 38 mm

Roux-Magnus Retractor

- 08-291** 16 cm, 6 1/4" 23 x 26 mm / 29 x 38 mm

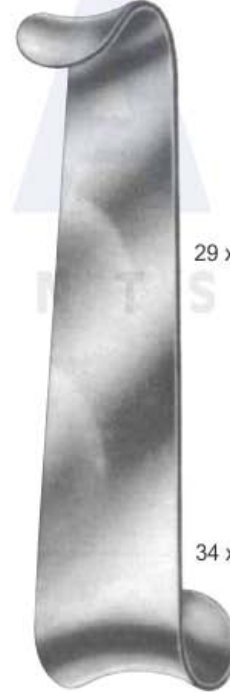
Roux-Magnus Retractor

- 08-292** 17 cm, 6 3/4" 29 x 29 mm / 34 x 44 mm

08-293

- Baby (7x100mm)
- 08-294** infantil (10x120mm)
- 08-295** Adult (13x125mm)
- 08-296** Adult (15x150mm)
- 08-297** Extra Large (20x180mm)

Farabeuf Retractor



Farabeuf Retractor
Set 2 Pcs.
08-298 13 cm, 5"
30 x 10 / 34 x 13 mm
08-299 13 cm, 5"
26 x 10 / 30 x 13 mm



Farabeuf Retractor
Set 2 Pcs.
08-300 15 cm, 6"
27 x 16 / 30 x 16 mm
08-301 15 cm, 6"
23 x 16 / 26 x 16 mm



Parker Retractor
Set 2 pcs.
08-302 13.5 cm, 5 1/4"
22 x 15 mm / 22 x 15 mm
08-303
18.4 cm 7 1/4"



Parker Retractor
08-304 13.5 cm, 5 1/4"
18 x 15 mm / 19 x 15 mm

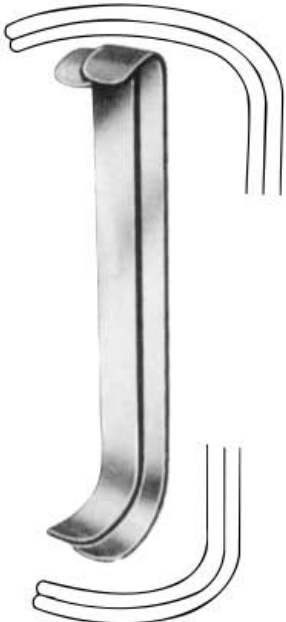

Collin Retractor
Set 2 pcs.
08-305 16.5 cm, 6 1/2"
25 x 12 / 35 x 16 mm
08-306 16.5 cm, 6 1/2"
20 x 12 / 30 x 16 mm



Mayo-Collin Retractor
Set 2 pcs.
08-307 15 cm, 6"
28 x 18 / 25 x 18 mm



Parker-Langenbeck Retractor
Set of 2 Pcs.
08-308 25 x 15 mm fig. 2
08-309 21 x 15 mm fig. 1
08-310 40 x 15 mm fig. 1
08-311 46 x 15 mm fig. 2



Parker-Mott Retractor
08-312
16 cm 6 1/4"
68 x 24 / 74 x 24 mm

08-313
115 x 65 mm



08-314
115 x 38 mm



08-315
82 x 22 mm



08-316
130 x 38 mm



Coryllos Retractor
22.5 cm, 8 3/4"

08-317
72 x 20 mm

08-318
55 x 23 mm

08-319
45 x 15 mm



Sauerbruch Retractor
25 cm, 10"

Davidson Retractor
08-320 16 cm, 6 1/4" 75 x 50 mm
08-321 16 cm, 6 1/4" 75 x 90 mm

<i>Wundhaken</i>	<i>Ecarteurs</i>
<i>Separadores</i>	<i>Divaricatori</i>



Bruner Retractor
25 cm, 10"

08-322
180 x 30 mm

08-323
160 x 30 mm

08-324
140 x 30 mm

08-325
130 x 30 mm

08-326
120 x 25 mm

08-327
100 x 25 mm

08-328
80 x 20 mm

180 x 30 mm

160 x 30 mm

140 x 25 mm

120 x 25 mm

100 x 20 mm

80 x 20 mm

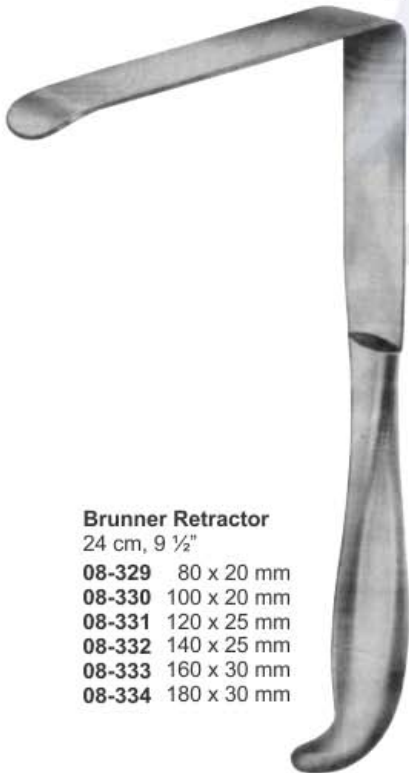

Bruner Retractor
24 cm, 9 1/2"

08-329 80 x 20 mm
08-330 100 x 20 mm
08-331 120 x 25 mm
08-332 140 x 25 mm
08-333 160 x 30 mm
08-334 180 x 30 mm



Bruner Retractor
24 cm, 9 1/2"

08-335 80 x 20 mm
08-336 100 x 20 mm
08-337 120 x 25 mm
08-338 140 x 25 mm
08-339 160 x 30 mm
08-340 180 x 30 mm



**Deaver Retractor
08-341**
18 cm, 7"

**Deaver Retractor
08-342**
21.5 cm, 8 ½"

**Deaver Retractor
08-343**
23 cm, 9"

**Deaver Retractor
08-344**
30 cm, 11 ¼"

**Deaver Retractor
08-345**
33 cm, 13"

**Deaver Retractor
08-346**
36 cm, 13 ½"



**Deaver Retractor
08-347**
30 cm, 11 ¼"

**Deaver Retractor
08-348**
30 cm, 11 ¼"

**Deaver Retractor
08-349**
30 cm, 11 ¼"

**S-Shaped Retractor
08-350**
21 cm, 8 ¼"
12 mm



Mikulicz Retractor
26 cm, 10 ¼"
08-351
85 x 50 mm

Kelly Retractor
27 cm, 10 ½"
08-352
190 x 38 mm
08-353
190 x 57 mm



Mikulicz Retractor
26 cm, 10 ¼"
08-354
95 x 35 mm

Mikulicz Retractor
26 cm, 10 ¼"
08-355
120 x 50 mm
08-356
150 x 50 mm



Cheek-And Lip Retractor
19 cm, 7 ½"
08-357
Movable



Tuffier Retractor
23 cm, 9"
08-358 55 x 63 mm



Bennet Retractor
08-359
24cm



Doyen Retractor
25 cm, 10"
08-360 50 x 85 mm



Fritch Retractor
08-361
2.75 x 2 mm



Fritch Retractor
24 cm, 9 ½"
08-362 35 x 40 mm



Fritsch Retractor
08-363 24 cm, 9 1/2" 30 x 30 mm
08-364 24 cm, 9 1/2" 32 x 40 mm
08-365 24 cm, 9 1/2" 40 x 50 mm
08-366 24 cm, 9 1/2" 40 x 60 mm
08-367 24 cm, 9 1/2" 45 x 75 mm
08-368 24 cm, 9 1/2" 65 x 85 mm



Mikulicz Retractor
08-369
 29 cm 11.5"



Tuffier Retractor
08-370 23 cm 9"
 64 x 60mm



Harrington Retractor
 32 cm, 12 3/4"
08-371
 127 x 40 mm
08-372
 127 x 62 mm



Harrington Extra Deep Retractor
08-373 30cm 11 3/4"
 Hollow handle, 5.7cm
 width x 20.5cm 8" depth blade



Harrington Splanchnic Retractor
08-374 31.5cm 12 1/2"
 Hollow handle, 3.8cm 1 1/2"
 width x 12.0cm 4 3/4"
 depth blade



Debakey-Cooley Retractor
08-375 31.0cm 12 1/4"
 Hollow handle, 5.7cm 2 1/4"
 width x 18.4cm 7 1/4"
 depth blade



Meyerding Retractor
08-376
 22.5 cm, 9"
 75 x 25mm



08-377
 50 x 16mm

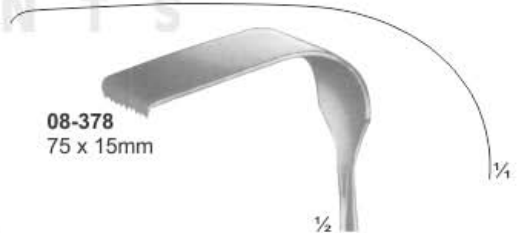

08-378
 75 x 15mm

Goelet Retractor
08-379
 19 cm 7 1/2"
 Double Ended

Wundhaken, Venenhäkchen
Separadores, Ganchitos Para venas

Ecarteurs, Ecarteurs sous
Divaricatori, Divaricatori per veni



08-380



Kaye-Millard Retractor
08-381
8 cm, 3 ¼"



Richardson/Kelly Retractor
08-382
24 cm, 9 ½"



08-382
5 x 31mm



08-383
19 x 51mm



08-384
38 x 51mm



08-385
64 x 76mm



Ross Retractor
25.5 cm, 10"



08-386
Fig.01



08-387
Fig.02



08-388
Fig.03



08-389
Fig.04



08-390
Fig.05



¼
08-391
Fig.06



Weinberg Vagotomy Retractor (joe's Hoe)
08-392 20 cm, 8"
Blade 102 x 165 mm wide

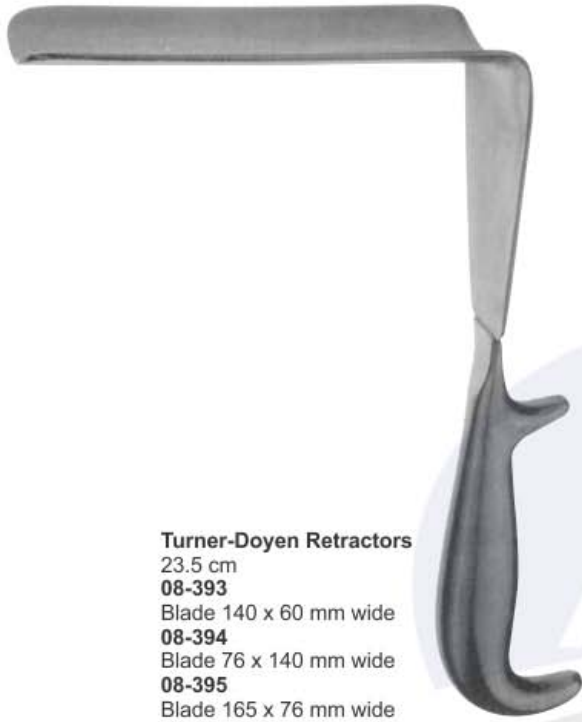

Turner-Doyen Retractors
23.5 cm
08-393
Blade 140 x 60 mm wide
08-394
Blade 76 x 140 mm wide
08-395
Blade 165 x 76 mm wide

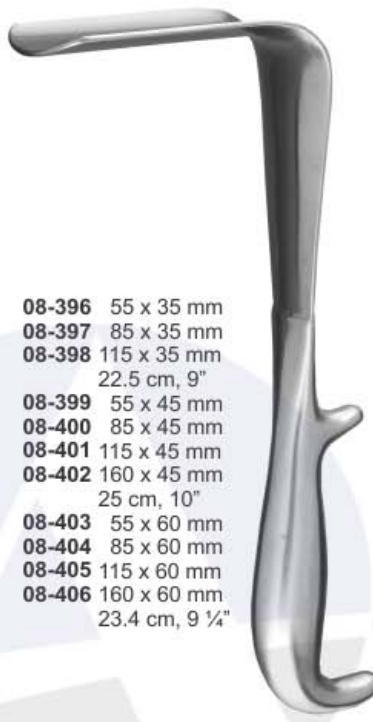

08-396 55 x 35 mm
08-397 85 x 35 mm
08-398 115 x 35 mm
22.5 cm, 9"
08-399 55 x 45 mm
08-400 85 x 45 mm
08-401 115 x 45 mm
08-402 160 x 45 mm
25 cm, 10"
08-403 55 x 60 mm
08-404 85 x 60 mm
08-405 115 x 60 mm
08-406 160 x 60 mm
23.4 cm, 9 1/4"

Doyen Vaginal Retractors



08-407 23cm
Small Blade 70x19mm wide
08-408 25cm
Medium Blade 82x29mm wide
08-409 28cm
Large Blade 22X64mm
08-410 28cm
Large Blade 38X89mm

Sawyer Retractors



08-411 23cm
Blade 60x24mm wide
08-412 25cm
Blade 75x35mm wide

Ferguson-Moon Rectal Retractors



08-413 23cm
Blade 64x24mm wide
08-414 23cm
Blade 76x32mm wide
08-415 25cm
Blade 76x35mm wide

Hill Ferguson Rectal Retractors



08-416 24cm
50x40mm wide
08-417 24cm
65x50mm wide
08-418 25cm
75x65mm wide
08-419 25cm
90x75mm wide

Kelly Retractors



Richardson Retractors



08-420 24cm
Blade 25x20mm wide
08-421 24cm
Blade 36x28mm wide
08-422 24cm
Blade 44x28mm wide
08-423 25cm
Blade 52x22mm wide
08-424 25cm
Blade 70x52mm wide

Wundhaken | Ecarteurs
 Separadores | Divaricatori



Kelly Retractor
 08-425 25cm
 55x50mm



Kelly Retractor
 26cm

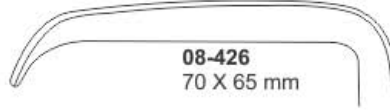

08-426
 70 X 65 mm

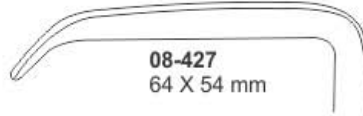

08-427
 64 X 54 mm

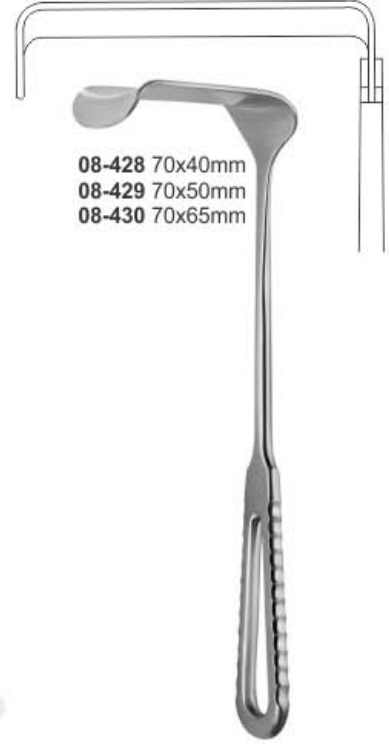

08-428 70x40mm
08-429 70x50mm
08-430 70x65mm

Morris Retractor
 24.5 cm 9 3/4"



47 x 21 mm

Richardson Retractor
 08-431 24cm



Richardson Retractor
 24.0 cm 9.5"



08-432
 23 x 20 mm



08-433
 30 x 29 mm



08-434
 37 x 37 mm



38 x 37 mm

22 x 21 mm

08-436
 39 x 30 mm

08-435
 64 x 43 mm

Richardson-Eastman Retractor
 25.0 cm 10", Set of 2 piece



Malleable Retractor

Item	Description	Tip
08-437	20 cm	12 mm
08-438	20 cm	17 mm
08-439	20 cm	25 mm
08-440	33 cm	25 mm
08-441	33 cm	32 mm
08-442	33 cm	40 mm
08-443	33 cm	50 mm



Ribbon Retractor
08-444
20 cm, 8"
Width 4 cm



Ribbon Retractor
08-445
20 cm, 8"
Width 2.5 cm



Tuffier / Haberer Retractor
08-446 20 cm, 8"
17 x 25 mm
08-447 28 cm,
11" 25 x 30 mm
08-448 30 cm,
11 3/4" 37 x 45 mm
malleable



Bruening Spatula
08-449
19 cm



Flexival Abdominal Spatula
08-450 300x20mm
08-451 300x25mm
08-452 300x30mm
08-453 300x35mm
08-454 300x40mm
08-455 300x45mm
08-456 300x50mm



Reverdin Retractor
08-457
28cm
46x60mm



Reverdin Retractor
08-458
29cm



Blood Scoop
08-459
15cm



Heiss Retractor
08-460 10cm
Sharp 4:4
08-461 10cm
Blunt 4:4



Finsen Retractor
08-462 7 cm, 2 3/4"
3 x 4 teeth, sharp
08-463 7 cm, 2 3/4"
3 x 4 teeth, Blunt



Finsen Retractor
08-464 5 cm, 2"
2 x 3 teeth sharp/blunt
08-465 7 cm, 2 3/4"
2 x 3 teeth sharp/blunt

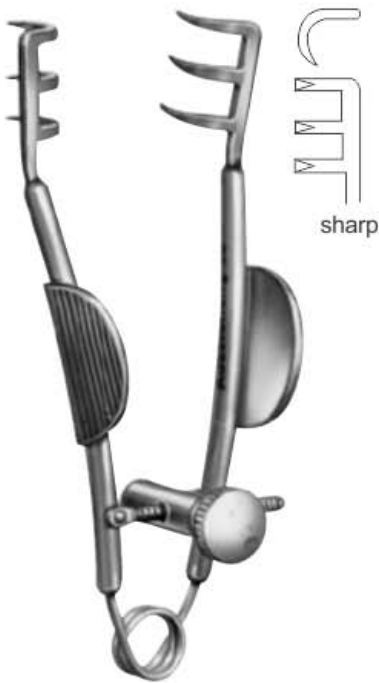

Buckley Retractor
08-466 6cm



Lancaster Eye Speculum
08-467 8.3cm
blades 15 X 5 mm



Castroviejo Eye Speculum
08-468 9.5cm
medium blades
15 X 5 mm O.D.



ALM Retractor
08-469 7 cm, 2 3/4"
4 x 4 teeth sharp/blunt
08-470 10 cm, 4"
4 x 4 teeth sharp/blunt



Wire Retaining Retractor
08-471 8.5 cm, 3 1/2" 3 x 3 Prong
08-472 8.5 cm, 3 1/2" 1 x 1 Prong Sharp



Farr Wire Retractor
08-473 14 cm 5 1/2"
prongs 1.9 cm 3/4"



Jansen Retractor
08-474 10 cm, 4"
 Sharp 3x3
08-475 10 cm, 4"
 Blunt 3x3



Houzel Retractor
08-476 29 cm, 11 1/2"



Mollison Retractor
08-477 15cm, 6"
 sharp



Milligan Retractor
08-478 13 cm, 5"
 18.5 mm x 20 mm
 Blunt, 3x3



Markham/Meyerding Retractor
08-479 18cm, Blade 55 x 25 mm Left
08-480 18cm, Blade 55 x 25 mm Right



Darling Retractor
08-481 18 cm, 7"
 40 x 76/25 x 54 mm
08-482 18 cm, 7"
 25 x 64/40 x 76 mm
 Laminectomy Retractors
 1 blade toothed



Debakey Gelpi Retractor
08-483 13.5cm 5 3/8"
 Spread 3 1/8" 8cm, Sharp,

Gelpi-Loktite Retractor

- 08-484** 9cm
- 6 mm Sharp
- 08-485** 11cm
- 10 mm Sharp
- 08-486** 14cm
- 10 mm Sharp
- 08-487** 16cm
- 10 mm Sharp
- 08-488** 19cm
- 10 mm Sharp

Gelpi-Perineal Retractor
08-489 17.8cm
 ball stops on sharp tenaculum
 prongs, arm length 12cm

Gelpi-Loktite Retractor
08-490 9 cm, 6mm Sharp Cross Over
08-491 11 cm, 10mm Sharp Cross Over
08-492 14 cm, 10mm Sharp Cross Over
08-493 16 cm, 10mm Sharp Cross Over
08-494 19 cm, 10mm Sharp Cross Over

Seletz-Gelpi Retractor
08-495 17.8cm, 7"
 modified with long
 curve in shanks

Schuhknecht Retractor
08-496 Sharp
08-497 Blunt
 14 cm, 5 1/2"

Wullstein Retractor
08-498 **08-501** 10.5 cm, 4"
08-499 **08-502** 13.0 cm, 5"
08-500 **08-503** 16.0 cm, 6 1/4"
 Sharp Blunt

Travers Retractor
08-504
 21 cm, 8 1/4" Blunt



Righby Retractor
08-505 35 x 20 mm
08-506 60 x 20 mm
08-507 65 x 15 mm
 18 cm, 7"



Weitlaner Retractor
08-508
 13.0 cm 5.25"
 Sharp

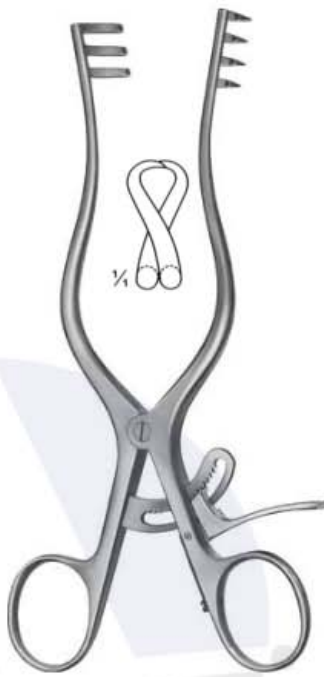

Weitlaner Retractor
08-509
 16.5 cm 6.5"
 Sharp



Plester Retractor
08-510
 11.0 cm 4.25"
 Blunt



Perkins Retractor
08-511 13cm



Weitlaner Retractor
08-512 11 cm
 Sharp



Weitlaner Retractor
08-513 11 cm
 Semi-Sharp



Weitlaner Retractor
08-514 11cm
Blunt

Weitlaner Retractor
08-515 13cm
Sharp

Weitlaner Retractor
08-516 13cm
Semi-Sharp

Weitlaner Retractor
08-517 13cm
Blunt



Kolbel Soft Tissue Retractor
08-518 18.0cm 7"
Angled, 2 x 2 Pronged

Meyerding Retractor
08-519 16.5cm 6 1/2"
08-520 24.1cm 9 1/2" Large Blade
8.9 cm 3 1/2" X 5.1 cm 2"
08-521 24.1 cm 9 1/2" Small Blade
5.1 cm 2" X 1.6 cm 5/8"

D'Errico-Adson Retractor
08-522 19.0cm 7 3/8"
4 X 4-pronged,
2.0cm 3/4" depth blade
Sharp

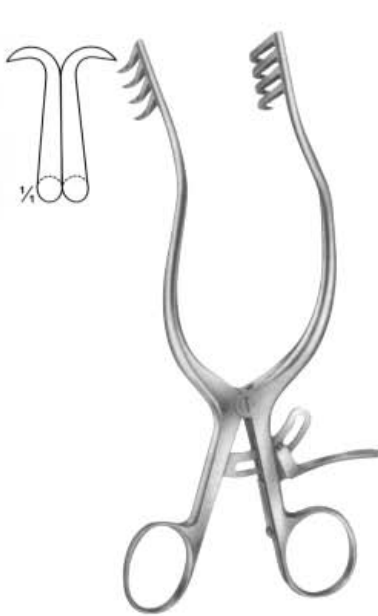

Anderson-Adson Retractor
08-523 19.0 cm 7 1/2"
Sharp

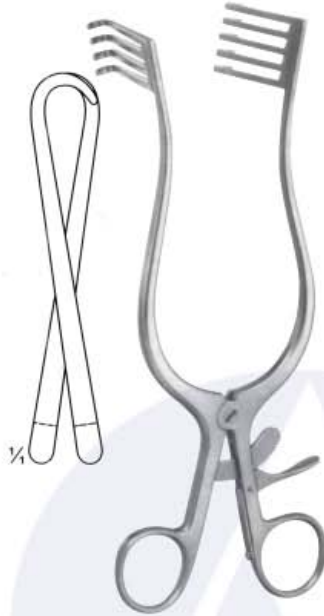

Norfolk & Norwich Retractor
08-524 22.0 cm 8 3/4"
Blunt



Adson Retractor
08-525
19.1 cm 7-1/2" sharp,
4 X 4 teeth straight Arms

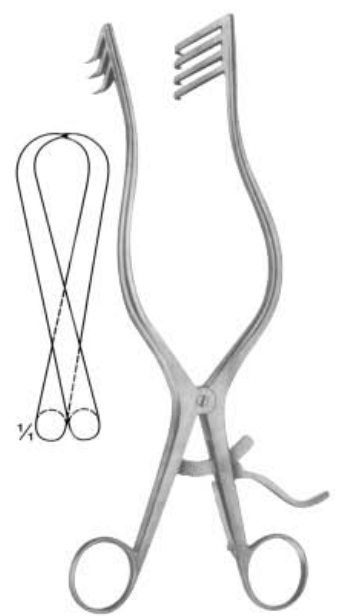

Adson Retractor
08-526 26.5 cm 10 1/4"
Sharp



Beckman-Weitlaner Retractor
08-527 16.5cm 6 1/2"
3 x 4 Sharp prongs



Beckman-Weitlaner Retractor
08-528 16.5cm 6 1/2"
3 x 4 Blunt prongs



Cone Retractor

08-529 31 cm, 12"
3x4 Blunt prongs,
13 mm x 14.5 mm
08-530 16.5 cm, 6 1/2"
17 mm x 19 mm
3x4 Sharp prongs,
08-531 16.5 cm, 6 1/2"
17 mm x 19 mm
3x4 Blunt prongs,
08-532 20 cm, 8"
21 mm x 210 mm
3x4 Blunt prongs,



Beckman Retractor
08-533 31.7cm 12 1/2"
 Spread 3.5cm 5 3/8" 4 x 4
 Sharp prongs, Arm length
 8.5cm 3 3/8"



Beckman Retractor
08-534 31.1cm 12 1/4"
 4 x 4 Sharp prongs 27mm,
 Side Blade 1.7cm 5/8" deep,



Beckman Retractor
08-535 31.1cm 12 1/4"
 4 x 4 Blunt prongs 27mm,
 Side Blade 1.7cm 5/8" deep,



Joll (Friedman)
08-536 15.5 cm, 6 1/2"
 Thyroid- and Vaginal Retractor



Jackson Burrows Retractor
08-537 18.5cm
 Blunt



Gelpi Vaginal Retractor
08-538 13.5cm



Gelpi Skin & Vaginal Retractor
08-539 17.5cm



De Bakey Femur Retractor
08-540 14.5cm

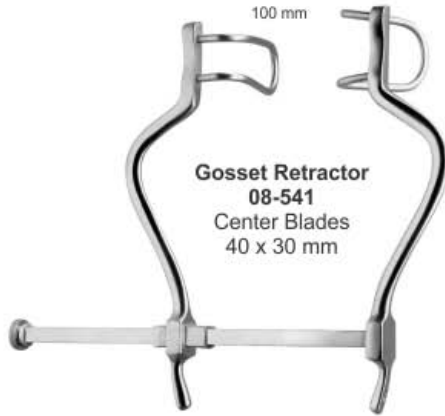

**Gosset Retractor
08-541**
Center Blades
40 x 30 mm

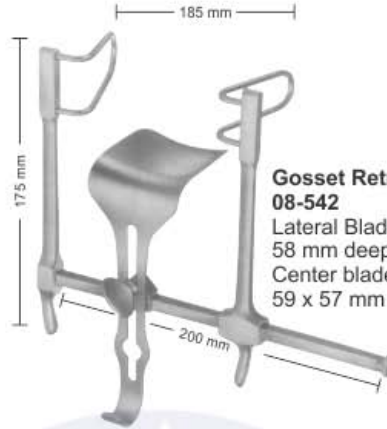

**Gosset Retractor
08-542**
Lateral Blades
58 mm deep
Center blade
59 x 57 mm

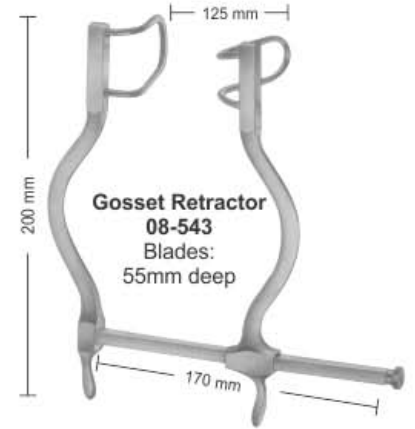

**Gosset Retractor
08-543**
Blades:
55mm deep

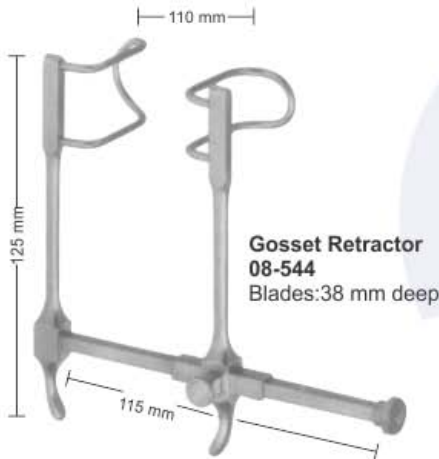

**Gosset Retractor
08-544**
Blades:38 mm deep

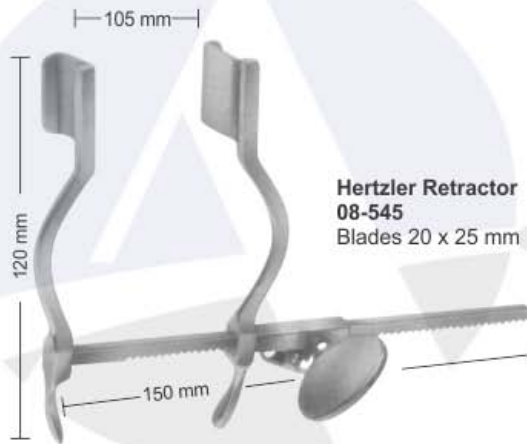

**Hertzer Retractor
08-545**
Blades 20 x 25 mm

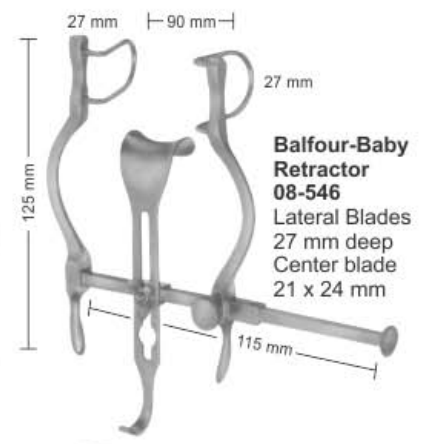

**Balfour-Baby
Retractor
08-546**
Lateral Blades
27 mm deep
Center blade
21 x 24 mm



**Balfour Retractor
08-547**
Lateral blades
60 mm deep
Center blade
47 x 80 mm

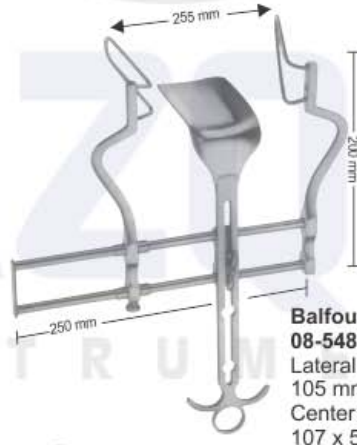

**Balfour Retractor
08-548**
Lateral blades
105 mm deep
Center blade
107 x 59 mm



08-549
Center blade only
54 x 80 mm

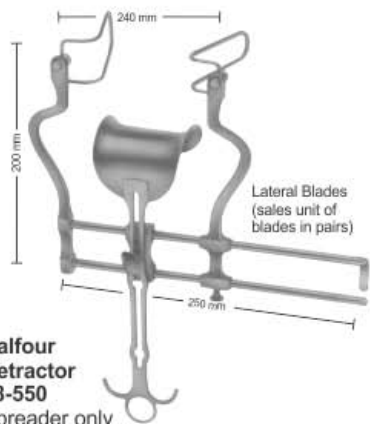

**Balfour
Retractor
08-550**
Spreader only

- 08-551**
50 mm
 - 08-552**
60 mm
 - 08-553**
75 mm
 - 08-554**
90 mm
 - 08-555**
80 x 80 mm
- Lateral Blades
(sales unit of
blades in pairs)



Finochietto Retractors
08-555 18x22 8cm
08-556 25x40 13cm
08-557 38x45 16cm
08-558 40x45 18cm



Gosset Abdominal Retractors
08-559 12cm
08-560 16cm
08-561 24cm
08-562 30cm



08-565
Single Retractor Blade
110 x 70 mm

O'Sullivan/O'Connor Retractor
08-563 (Set includes frame & 3 blades)
08-564 Frame Only (not pictured)



08-566
Set of 2 Retractor Blade
80 x 45 mm



**ABRE BOCA MC IVOR C/3
LAMINAS S/ SUCCAO
ABRE BOCA
08-567**



08-568
Center Blade
45 x 80 mm
70 x 85 mm

Sizes of These Blades to
Same as about Blades.



08-569
Center Blade
100 x 60 mm



Collin Retractor
08-570 Complete
08-571 Spreader only
08-572 Blades 55 x 25 mm
08-573 Blades 80 x 25 mm
08-574 Center Blade
115 x 45 mm

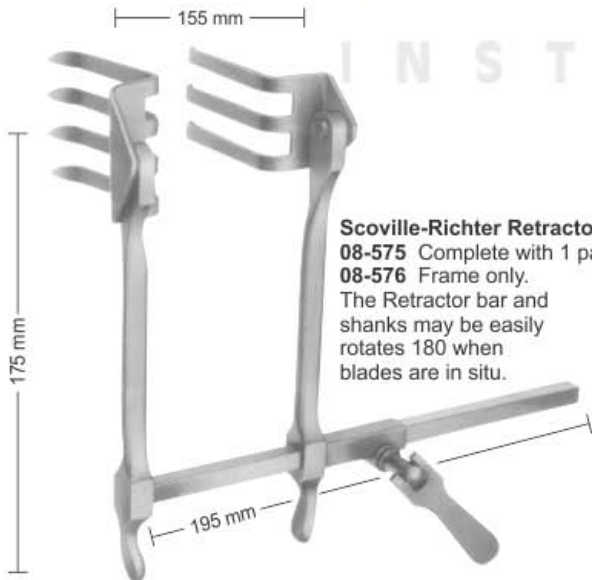

Scoville-Richter Retractor
08-575 Complete with 1 pair blades.
08-576 Frame only.
The Retractor bar and
shanks may be easily
rotates 180 when
blades are in situ.



08-577
62 x 52 mm

08-578
62 x 37 mm

08-579
47 x 51 mm



08-580
30 x 40 mm



08-581
37 x 62 mm



Initial Incision Retractor
08-582 30cm 11 3/4"
Complete



Legueu Retractor
08-583
17 cm, 6 3/4"



Collin Retractor
08-584 20 cm, 8"
complete with 2 lateral
blades and central blade



Doyen Retractor
08-585 48 mm x 90 mm
08-586 48 mm x 105 mm
08-587 48 mm x 120 mm
08-588 48 mm x 135 mm
28 cm, 11"



Rochard Retractor
08-589 48 mm x 90 mm
08-590 48 mm x 105 mm
08-591 48 mm x 120 mm
08-592 48 mm x 135 mm
08-593 48 mm x 155 mm
31 cm, 12"

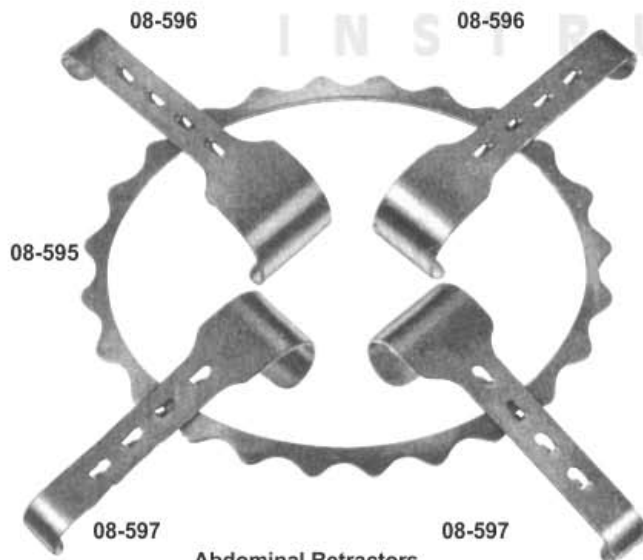

Abdominal Retractors
for new-born and children

Denis-Browne Retractor
08-594 Complete with 4 blades

- 08-595 Frame 190 x 160 mm
- 08-596 2 blades only 40 x 30 mm
- 08-597 2 blades only 40 x 40 mm

08-598
Blades only 20 x 30 mm

08-599
Blades only 20 x 40 mm



Wundhaken | Ecarteurs
Separadores | Divaricatori

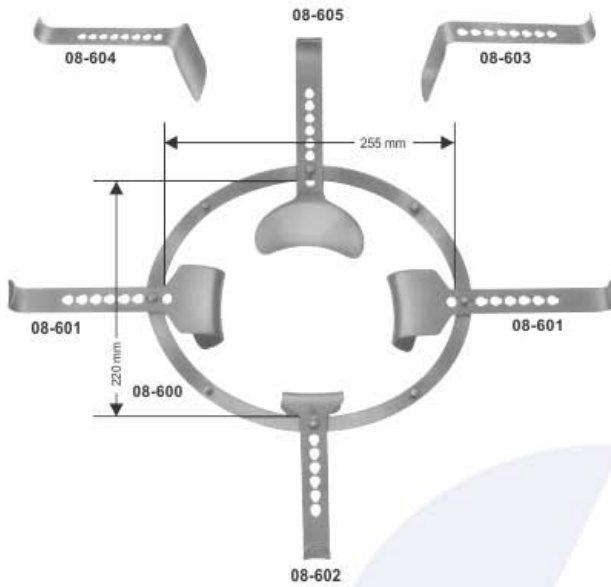

Abdominal Retractors
well suitable for gynaecologists

Semm Abdominal Retractors
consisting of:

- 08-600** 1 frame 225 x 220 mm
- 08-601** 2 blade 46 x 64 mm
- 08-602** 1 blade 53 x 54 mm (for bladder)
- 08-603** 1 blade 82 x 97 mm (for intestine)
- 08-604** 1 blade 98 x 51 mm (for intestine)
- 08-605** 1 blade, narrow 107 x 36 mm

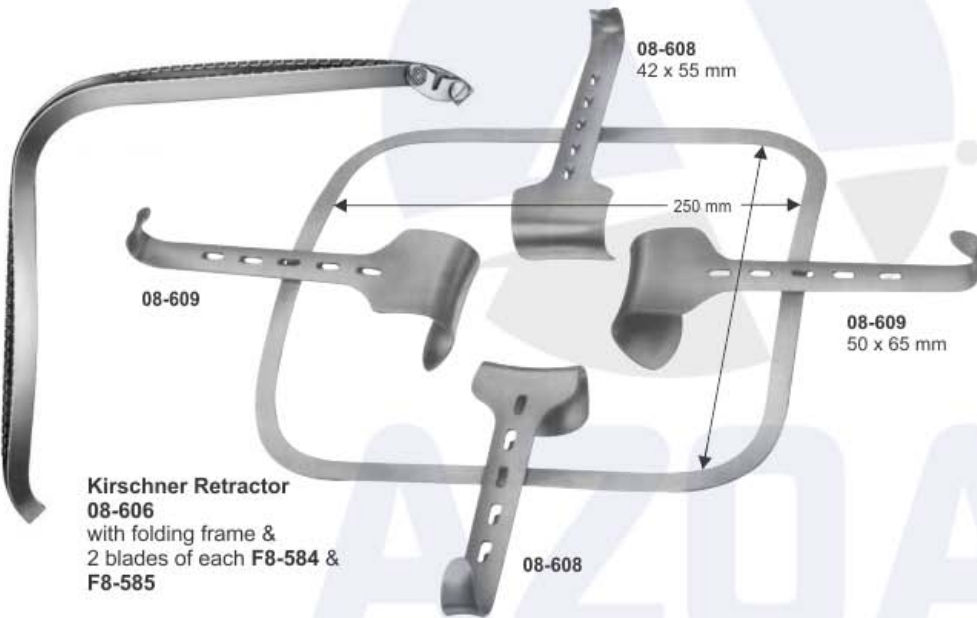

Kirschner Retractor 08-606
with folding frame & 2 blades of each **F8-584** & **F8-585**

Kirschner Retractor 08-607
with vaulted fixed frame & 2 blades of each **08-608** & **08-609**

08-610
300 x 380 mm
Frame only, over-sized

08-611
320 x 300 mm
Frame only

Additional valves for corpulent persons



Kirschner Retractor 08-612
64 x 80 mm



Kirschner-Balfour Retractor 08-613
80 x 82 mm



Kirschner Retractor 08-614 90 x 69 mm
08-615 92 x 95 mm
08-616 78 x 58 mm



Kirschner Retractor 08-617 108 x 42 mm
08-618 91 x 55 mm
08-619 121 x 55 mm

PLASTIC SURGERY INSTRUMENTS





09-001
Grossmann Areola Marker,
40mm,44mm, 48mm, 52mm



Freeman Areola Marker,
2 Sizes,
09-002 34mm / 36mm
09-003 38mm / 42mm
09-004 42mm / 45mm
09-005 45mm / 50mm



Freeman Areola Marker,
09-006 34mm
09-007 36mm
09-008 38mm
09-009 42mm
09-010 45mm
09-011 50mm



Freeman Areola Marker,
09-012 38 mm
09-013 42 mm
09-014 50 mm
09-015 45 mm
09-016 34 mm
09-017 36 mm



Solz Areola Marker, Blunt,
09-018 36mm Diameter
09-019 40mm Diameter
09-020 42mm Diameter
09-021 45mm Diameter



Solz Atraumatic
Breast Dissector,
09-022 34cm
09-023 37cm



Solz Breast Hook
Dissector,
09-024 36cm



Agris Dingman Breast
Dissector, Set of 2,
Left And Right,
09-025 36cm



Maccollum Dingman
Submammary
Dissector,
09-026 30cm



Maccollum Dingman
Breast Dissector,
09-027 31.5cm
09-028 41cm



Reynolds Transauxillary
Breast
Dissector, Fenestrated,
09-029 33cm
09-030 40cm



Breast Dissector,
Angulated Blade,
09-031 33cm
09-032 42cm



Breast Dissector,
Spatulated Blade,
09-033 33cm
09-034 42cm



Breast Dissector,
Oval Spatulated
Blade,
09-035 33cm
09-036 42cm



Spatula Breast
Retractor
Dissector,
Serrated,
09-037 1/2",
Semi Malleable



Trocarn Breast Tube,
09-038 356mm
Total Length,
Large, 17.3mm Id,
19mm Od
09-038 343mm
Small, 14mm Id, 16mm Od



Penn Breast
Dissector,
Straight,
09-039
25mm Width
324mm Length



Maccollum
Dingman
Breast
Dissector
09-040
38mm Width,
432mm Length



Mcinnis
Polycurette
Breast
Instrument
09-041
30mm Width
09-042
318mm Length



Iconoclast,
09-043 Large
292mm Length
146mm Blade
09-044 Small
222mm Length,
83mm) Blade



Silverstein Breast
Dissector,
09-045
356mm Length

I N S T R U M E N T S



Breast Elevator For
Mammary Plasty
09-046



Temporal T
Dissector
09-047
23.5cm
12mm Tip,
Straight



Flap Dissector
09-048 23.5cm
5mm Tip, Straight



Midface Facial
Dissector
09-049 24cm
Multiple Curves,
12mm Wide Tip



Transoral
Dissector
09-050
23.5cm
Curved Tip



Frontotemporal Dissector
09-051 22.5cm
 5mm Tip, Slightly Curved
09-052 23cm
 7mm Tip, Slightly Curved
09-053 23cm
 10mm Tip, Slightly Curved



Scalp Elevator 24cm
09-054 12.5mm Tip, Slightly Curved
09-055 15mm Tip, Slightly Curved
09-056 7mm Tip, Straight
09-057 12.5mm Tip, S Shaped
09-058 12.5mm Tip, Slightly Curved
09-059 7mm Tip, Curved Tip
09-060 7mm Tip, Strongly Curved
09-061 7mm Tip, Slightly Curved



Orbital Rim Dissector
09-062 22.5cm
 Slightly Curved



Frontoglabbellar Dissector
09-063 26.5cm
 7mm Tip, S Shaped



Arcus Marginalis Dissector
09-064 24cm
 10mm Tip, S Shaped



Periosteal Elevator
09-065 25cm
 S Shaped



Periosteal Spreader
09-066 24cm
 8mm Tip, S Shaped



Periosteal Spreader
09-067 24cm
 10mm Wide Blade, S Shaped



Zygomatic Arch Elevator
09-068 20.5cm
 Straight Blade, 5mm



Scalp Elevator With Suction
09-069 24cm
 7mm Wide Tip, Slightly Curved



Scalp Elevator With Suction
09-070 26cm
 8.5mm Wide Tip, Curved Tip



Langenbeck Bone Elevator
09-071 20cm, 7mm, Blunt
09-072 20cm, 10mm, Blunt

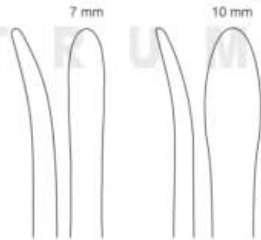

Suction Elevator With Guide
09-073 21cm, 4mm



Cottle Periosteal Elevator,
09-074 20cm,
 2/4mm, Double Ended, Fine
09-075 23cm,
 3/4mm, Double Ended





Masing Septum Elevator,
09-076 22cm
5mm, Double Ended

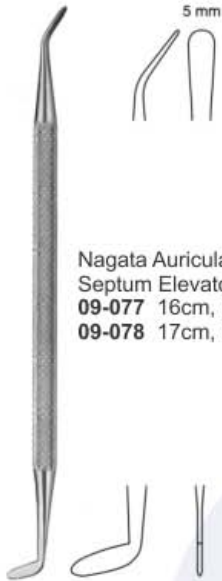

Nagata Auricular Septum Elevator,
09-077 16cm, Blunt
09-078 17cm, Blunt



Halle Septum Elevator,
Narrow, 3 mm
Width
09-079 178mm
Length



Freer Septum Elevator,
Double Ended, Sharp /
Blunt, Wide, 6.5mm Width,
09-080 197mm Length



Hajek Ballenger Septum Elevator, Double Ended,
8.5mm Width
09-081 191mm Length



Freer Septum Elevator,
Curved, Double Ended,
5mm Width
09-082 191mm
Length



Killian Septum Elevator,
Double Ended, 4 mm
With 3.4 Mm Taper, And
4.3 Mm With 3mm Taper,
09-083 184mm Length



Killian Septum Elevator,
Double Ended
09-084 229mm Length,
6mm With 4.5 Mm Taper
And 4.3mm With 3mm Taper



Howarth Septum Elevator,
Double Ended, 5mm Width
09-085 216mm Length



Gruber Combination
Knife Handle
/ Perichondrium Elevator #7
09-086 165mm) Length,
10/15c Blade Size



Obwegeser Rib Raspatory,
09-087 30cm, Left
09-088 30cm, Right

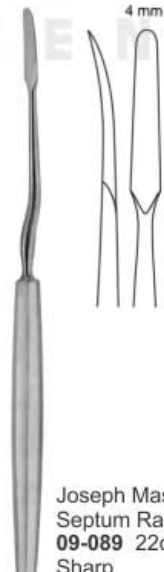

Joseph Masing
Septum Raspatory,
09-089 22cm, 4mm,
Sharp

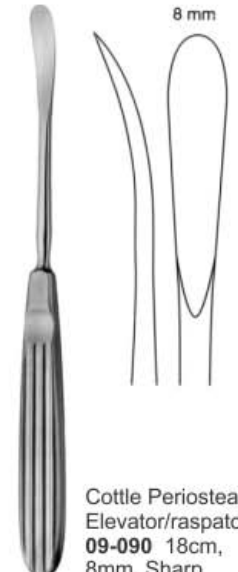

Cottle Periosteal
Elevator/raspatory,
09-090 18cm,
8mm, Sharp



Marx Breast Retractor,
09-091 27cm, 125 X 30mm
09-092 27cm, 140 X 30mm



Ferreira Style Retractor, With Fiber Optic Light Guide

With Smoke Tube	Without Smoke Tube
09-093 70 X 16 mm	09-108 70 X 16 mm
09-094 80 X 16 mm	09-109 80 X 16 mm
09-095 90 X 27 mm	09-110 90 X 27 mm
09-096 110 X 25 mm	09-111 110 X 25 mm
09-097 120 X 25 mm	09-112 120 X 25 mm
09-098 130 X 16 mm	09-113 130 X 16 mm
09-099 130 X 25 mm	09-114 130 X 25 mm
09-100 150 X 25 mm	09-115 150 X 25 mm
09-101 150 X 30 mm	09-116 150 X 30 mm
09-102 150 X 36 mm	09-117 150 X 36 mm
09-103 180 X 16 mm	09-118 180 X 16 mm
09-104 180 X 25 mm	09-119 180 X 25 mm
09-105 190 X 25 mm	09-120 190 X 25 mm
09-106 190 X 36 mm	09-121 190 X 36 mm
09-107 220 X 27 mm	09-122 220 X 27 mm



Breast Spatula With Handle
09-123 31.5cm, 25mmX18cm
 Blade, Serrated Tip, Semi Malleable



Wieder Breast And Facial Retractor /
 Tongue Depressor, Serrated,
09-124 14cm, 28mm, With Fiber Optic Light Guide
09-125 14cm, 38mm, With Fiber Optic Light Guide
09-126 15cm, 45mm, With Fiber Optic Light Guide



Wieder Breast And Facial Retractor /
 Tongue Depressor, Serrated,
09-127 14cm, 28mm
09-128 14cm, 38mm
09-129 15cm, 45mm



Breast Retractor, Double Ended,
09-130 31cm,
 Blades 22mm X 55mm and 38mm x 70mm
09-131 24cm,
 Blades 22mm x 55mm and 38mm x 70mm



Biggs Mammoplasty Retractors,
09-132 30mm
09-133 50mm
 With Fiber Optic Light Guide
09-134 30mm,
09-135 50mm,
 With Fiber Optic Light Guide And Suction



Biggs Mammoplasty Retractor,
09-136
 50mm Width, Standard,
 20cm Length



09-137 Biggs Mammoplasty Retractor,
 With Fiber Optic Light Guide 5.0cm
 Blade Width, 20cm Length



09-138 Biggs Mammoplasty Retractor,
 3cm Blade Width, Narrow,
 171mm Length



09-139 Biggs Mammoplasty Retractor,
 With Fiber Optic Light Guide,
 Narrow, 3.0cm Blade Width,
 15cm Length



09-140 Ferreira Breast Augmentation Retractor,
 25x171cm Blade, 130mm Handle Length



09-141 Ferreira Breast Augmentation Retractor, With Fiber Optic Light Guide, 25 X 171 Mm Blade Width, 130 Mm Handle Length Width

Tebbetts Retractor With Fiber Optic Light Guide, 18.5cm

With Irrigation Tube

- 09-142 70 X 16 mm
- 09-143 80 X 16 mm
- 09-144 90 X 27 mm
- 09-145 110 X 25 mm
- 09-146 120 X 25 mm
- 09-147 130 X 16 mm
- 09-148 130 X 25 mm
- 09-149 150 X 25 mm
- 09-150 150 X 30 mm
- 09-151 150 X 36 mm
- 09-152 180 X 16 mm
- 09-153 180 X 25 mm
- 09-154 190 X 25 mm
- 09-155 190 X 36 mm
- 09-156 220 X 27 mm

Without Irrigation Tube

- 09-157 70 x 16 mm
- 09-158 80 x 16 mm
- 09-159 90 x 27 mm
- 09-160 110 x 25 mm
- 09-161 120 x 25 mm
- 09-162 130 x 16 mm
- 09-163 130 x 25 mm
- 09-164 150 x 25 mm
- 09-165 150 x 30 mm
- 09-166 150 x 36 mm
- 09-167 180 x 16 mm
- 09-168 180 x 25 mm
- 09-169 190 x 25 mm
- 09-170 190 x 36 mm
- 09-171 220 x 27 mm

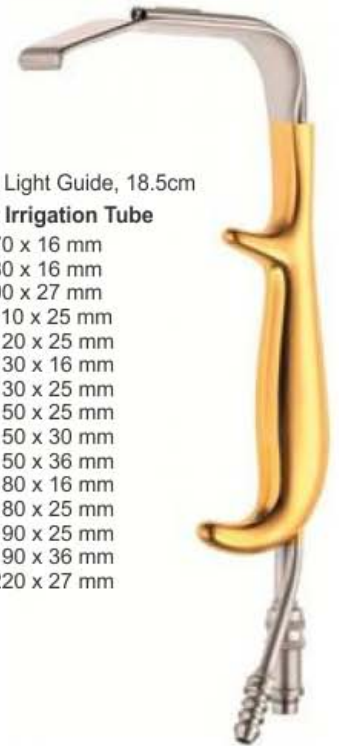

Tebbetts Fiber Optic retractor,
With Double Handle and Teeth at Tip

With Smoke Tube

- 09-172 70 x 16 mm
- 09-173 80 x 16 mm
- 09-174 90 x 27 mm
- 09-175 110 x 25 mm
- 09-176 120 x 25 mm
- 09-177 130 x 16 mm
- 09-178 130 x 25 mm
- 09-179 150 x 25 mm
- 09-180 150 x 30 mm
- 09-181 150 x 36 mm
- 09-182 180 x 16 mm
- 09-183 180 x 25 mm
- 09-184 190 x 25 mm
- 09-185 190 x 36 mm
- 09-186 220 x 27 mm

Without Smoke Tube

- 09-187 70 X 16 mm
- 09-188 80 X 16 mm
- 09-189 90 X 27 mm
- 09-190 110 X 25 mm
- 09-191 120 X 25 mm
- 09-192 130 X 16 mm
- 09-193 130 X 25 mm
- 09-194 150 X 25 mm
- 09-195 150 X 30 mm
- 09-196 150 X 36 mm
- 09-197 180 X 16 mm
- 09-198 180 X 25 mm
- 09-199 190 X 25 mm
- 09-200 190 X 36 mm
- 09-201 220 X 27 mm

Tebbetts Breast Augmentation Fiber Optic Retractor,
With Double Handle And Smooth End

With Smoke Tube

- 09-202 70x16mm
- 09-203 80x16mm
- 09-204 90x27mm
- 09-205 110x25mm
- 09-206 120x25mm
- 09-207 130x16mm
- 09-208 130x25mm
- 09-209 150x25mm
- 09-210 150x30mm
- 09-211 150x36mm
- 09-212 180x16mm
- 09-213 180x25mm
- 09-214 190x25mm
- 09-215 190x36mm
- 09-216 220x27mm

Without Smoke Tube

- 09-217 70x16mm
- 09-218 80x16mm
- 09-219 90x27mm
- 09-220 110x25mm
- 09-221 120x25mm
- 09-222 130x16mm
- 09-223 130x25mm
- 09-224 150x25mm
- 09-225 150x30mm
- 09-226 150x36mm
- 09-227 180x16mm
- 09-228 180x25mm
- 09-229 190x25mm
- 09-230 190x36mm
- 09-231 220x27mm

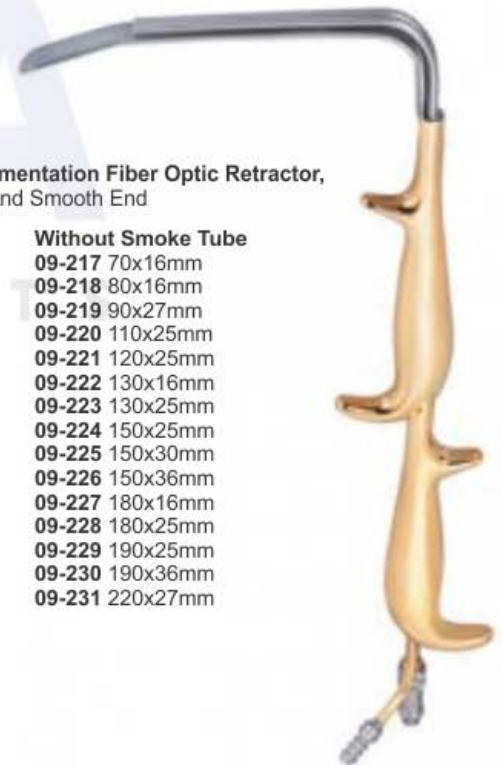



Tebbetts Breast Augmentation Fiber Optic Retractor, Insulated Blade With Smooth End, 18.5 Cm

With Smoke Tube	Without Smoke Tube
09-232 70x16mm	09-247 70x16mm
09-233 80x16mm	09-248 80x16mm
09-234 90x27mm	09-249 90x27mm
09-235 110x25mm	09-250 110x25mm
09-236 120x25mm	09-251 120x25mm
09-237 130x16mm	09-252 130x16mm
09-238 130x25mm	09-253 130x25mm
09-239 150x25mm	09-254 150x25mm
09-240 150x30mm	09-255 150x30mm
09-241 150x36mm	09-256 150x36mm
09-242 180x16mm	09-257 180x16mm
09-243 180x25mm	09-258 180x25mm
09-244 190x25mm	09-259 190x25mm
09-245 190x36mm	09-260 190x36mm
09-246 220x27mm	09-261 220x27mm

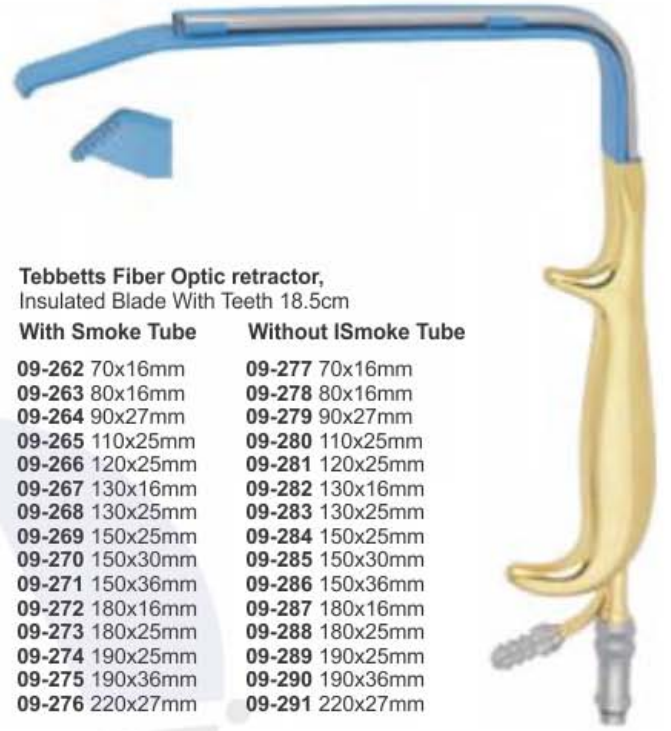

Tebbetts Fiber Optic retractor, Insulated Blade With Teeth 18.5cm

With Smoke Tube	Without ISmoke Tube
09-262 70x16mm	09-277 70x16mm
09-263 80x16mm	09-278 80x16mm
09-264 90x27mm	09-279 90x27mm
09-265 110x25mm	09-280 110x25mm
09-266 120x25mm	09-281 120x25mm
09-267 130x16mm	09-282 130x16mm
09-268 130x25mm	09-283 130x25mm
09-269 150x25mm	09-284 150x25mm
09-270 150x30mm	09-285 150x30mm
09-271 150x36mm	09-286 150x36mm
09-272 180x16mm	09-287 180x16mm
09-273 180x25mm	09-288 180x25mm
09-274 190x25mm	09-289 190x25mm
09-275 190x36mm	09-290 190x36mm
09-276 220x27mm	09-291 220x27mm



Sculpo Breast Retractors, 180 X 25mm Blade Size, With
09-292 5mm Endoscopic Scope Sheath
09-293 10mm Endoscopic Scope Sheath



09-294 Ring Breast Retractor With Fiber Optic Illumination And Irrigation Tube



Aiach Forceps,
09-295 16cm,
5mm Tip



Dingman Cartilage
Abraders,
Set of Two
09-296



Rubin Septal Morselizer
Forceps,
Set of Two
09-297 21cm



Rubin Septal Morselizer
Forceps,
T.c. (tungsten Carbide)
09-298 20cm



Mayo Scissors,
Supercut Plus T.c.
(tungsten Carbide)
09-299 17cm, Curved



Cottle Cartilage Crusher,
With Clamp, For
Taking Out The Prepared
Material,
09-300 65x30x30mm



Cartilage Cutting Block,
Teflon,
09-302 85x55x10mm



Gubisch Cartilage Crusher
09-301 65x30mm



Bone Mill, With Assembling
Wrench
09-303



Aufricht Nasal Retractor,
09-304 18cm
45x7-10mm



Aufricht Nasal Retractor
Double Ended, Blunt,
09-305 13.5cm
282-38x7mm



Aufricht Walter Nasal Retractor
Double Ended, Blunt,
09-306 13.5cm
283-38x7mm



Aufricht Walter Nasal Retractor
Double Ended, Sharp,
09-307 13.5cm
284-42x7mm



Cottle Alar Retractor,
09-308 15cm,
22x13mm



Walter Alar And Nasal Retractor
With Fiber Optic Illumination,
09-309 18.5cm



Gubisch Aufricht
Nasal Retractor,
09-310 17cm,
50x6-12mm



Aufrecht Nasal Retractor
09-311 16cm
 7mm Tip, 45mm
 Blade, With Fiber Optic
 Light Guide
09-312 18cm 10mm



Converse Blade Nasal Retractor,
09-313 20mm X 10mm Wide,
 With Fiber Optic Light Guide
09-314 30mm X 12mm Wide,
09-315 40mm X 12mm Wide,
09-316 50mm X 12mm Wide,



Fomon Nasal Retractor,
09-317 1 Ball End Prong
 16cm
09-318 2 Ball 16cm



Killian Nasal Speculum
 With Fiber
 Optics Illumination
09-319



Joseph Nasal Saw,
09-320 17cm,
 Straight



Joseph Nasal Saw,
09-321 17cm, Left
09-322 17cm, Right



Joseph Nasal Saw,
09-323 Angled To Left
09-324 Angled To Right

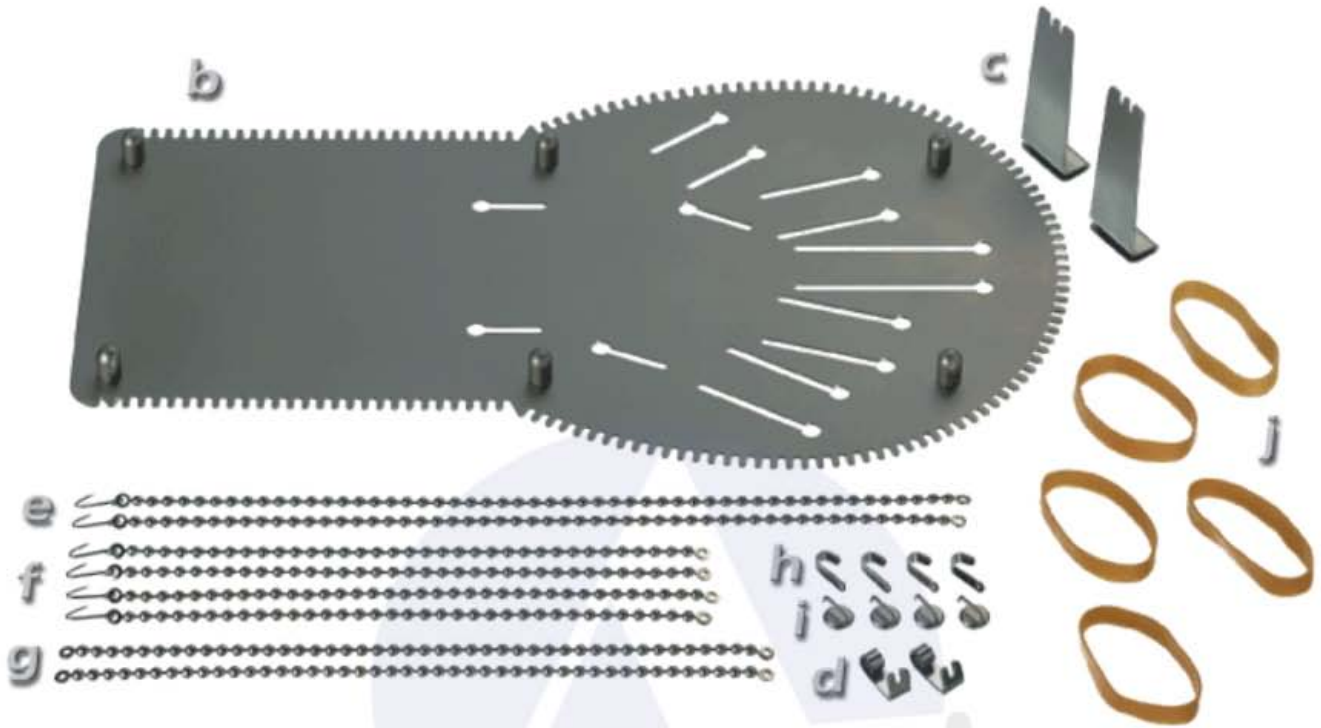

Tuppers Hand Retractor Set
09-325 Medium
09-326 For Infants
09-327 For Adults



Obwegeser Alveolar
(wisdom Tooth) Retractor,
09-328 22cm, 13/23 X 70mm



Obwegeser Nasal Spine Retractor,
09-329 22cm, 10/23 X 45mm



Obwegeser Iliac
Crest Retractor
09-330 22cm
 30/60 X 60mm

Obwegeser Iliac
Crest Retractor
09-331 22cm
 30/60 X 80mm

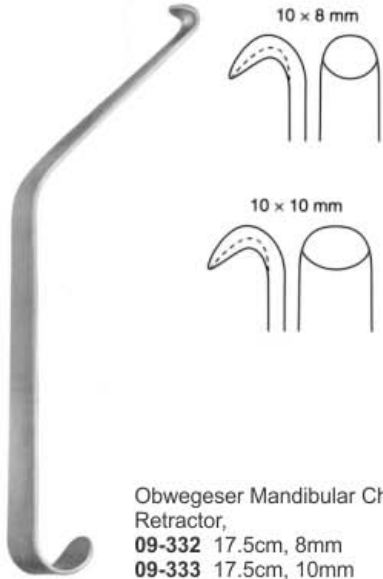

Obwegeser Mandibular Channel Retractor,
09-332 17.5cm, 8mm
09-333 17.5cm, 10mm



Obwegeser Chin Retractor,
09-334 16cm



Saldanha Solz Abdominal Retractor,
09-335 23.5cm



Killian Nasal Speculum With Fiber Optics Illumination
09-336



Deaver Retractor With Fiber Optics
09-337 Illumination, 16mm
09-338 Illumination, 25mm



Ferreira Face Lift Retractor With Fiber Optic Illumination 22 X 108mm
09-339



Freeman Flap Retractor With Fiber Optics Illumination,
09-340 20cm, 13mm
09-341 20cm, 25mm



09-342 Mandibular Channel Retractor 8mm, 17.5cm



09-343 Bremerich Mandibular Channel Retractor 10mm, 18cm



09-344 Ramus Retractor 20x80mm 16cm
09-345 Ramus Retractor 25x80mm 16cm
09-346 Ramus Retractor 30x80mm 16cm
09-347 Ramus Retractor 35x80mm 16cm



09-348 Medial Ramus Retractor left 19.5cm
09-349 Medial Ramus Retractor right 19.5cm



09-350
Bremerich Channel
Retractor 10mm,
22.5cm w/suction



09-351
Extra Oral
Retractor
24cm



09-352
Intra Oral
Retractor
24cm



09-353
Intra Oral
Retractor
L and M
w/o F/O
fitting.
25cm



09-354
Intra Oral
Retractor
right w/o
F/O fitting.
21cm



09-355
Intra Oral
Retractor
left w/o
F/O fitting.
21cm



09-356
Intra Oral Retractor
w/o F/O
Fitting 23cm



09-357
Intra Oral Retractor
With
F/O fitting 23cm



09-358
Intra Oral Retractor
Left
with F/O fitting
21cm



09-359
Intra Oral Retractor
right
w/F/O fitting. 21cm



**Levasseur Merrill Fiber
Optic Retractor for
Vertical Osteotomies**
09-360 Length 25cm
Working Tip 27mm



**Shea with Fiber Optic
(Multipurpose Retractor)**
09-361 Length 25cm
Working Tip 14.5mm

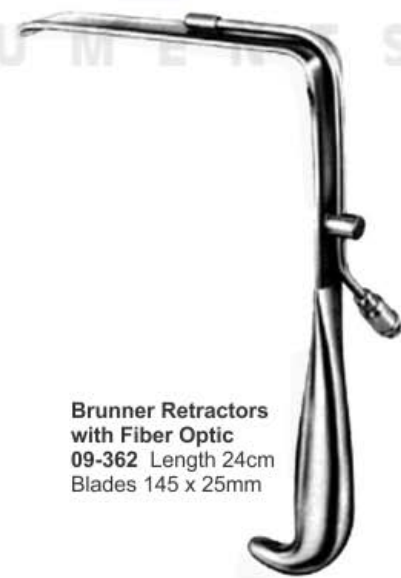

**Brunner Retractors
with Fiber Optic**
09-362 Length 24cm
Blades 145 x 25mm



09-363
Cheek and Lip
Retractor D/E
21x30mm,
26x35mm, 18cm



09-364
Schwenzer Cheek
Retractor 65x50mm,
17cm



09-365
Reuther Lliac
Crest
Retractor 24cm



09-366
Tessier Rib Graft
Retractor adult
120x28mm, 20.5cm



09-367
Lester
Retractor



09-368
Richardson Retractor
28x20mm



09-369
Richardson Retractor
38x28mm



09-370
Richardson Retractor
38x37mm



09-371
Richardson Retractor
52x22mm



**Aufrich Nasal Retractors
with Fiber Optic**
09-372 16cm 7mm
09-373 18cm 10mm



**Harrington Retractors
with Fiber Optic**
09-374 40 x 127mm
09-375 60 x 127mm

for Right cheem



**Bauer Retractor with
Fiber Optic**
09-376 26.5cm / 16mm
09-377 26.5cm / 16mm

for Left cheem





Petri Pterygoid Retractor with Fiber Optic
09-378 23cm, 25.5mm



Sigmoid Nptch Retractor with Fiber Optic
09-379 22cm, 16mm



Maliniac Nasal Ret with Fiber Optic
09-380 9mm x 45mm



09-381
Yancoskie Retractor
18cm, 6 sharp prongs



09-382
Coronal Brow Lift Retractor
18cm, 7 Sharp prongs



Freeman Retractor

09-383 18cm,
4 Sharp prongs
22mm, wide
09-384 18cm,
4 Blunt prongs
22mm, wide



Hook Retractor in-line prongs / four prongs 18cm
09-385 straight
09-386 narrow head
09-387 angled shaft
09-388 angled shaft 4 prong with shorter inner prongs 18cm



Anderson Bear Claw Retractor
09-389 12cm



Miniature model / with thumb ring / in-line prongs / four prongs
09-391 11.5cm



Miniature model / with thumb ring / in-line prongs / four prongs
09-390 6cm



Freeman Hook Retractor
four Prongs / with shorter inner prongs / seven prongs
09-392 18 cm



Freeman Hook Retractor
Seven Prongs / with shorter inner prongs / seven prongs
09-393 18 cm concave

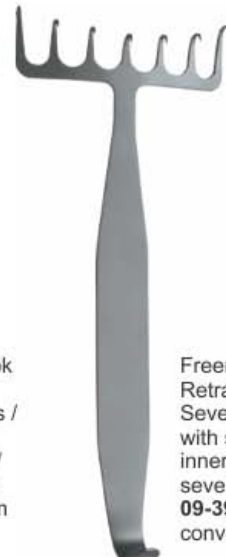

Freeman Hook Retractor
Seven Prongs / with shorter inner prongs / seven prongs
09-394 18 cm convex

BONE SURGERY INSTRUMENTS





Satterlee Saw
10-001 29cm
Stainless Steel Ring Handle
Straight tip, Straight shaft



Charriere Bone Saw
10-002 27cm
10-003 30cm
10-004 34cm
Straight tip, Straight shaft



Charriere Saw
10-005 35cm
Spare saw blades
10-006 12mm
10-007 15mm



Charriere Bone Saw Complete
10-008 35.5cm
Straight tip,
Straight shaft



Helferich-Bier Saw
10-009 39cm
Spare saw blades
10-010 3mm
10-011 5mm
10-012 5mm



Charriere Saw
10-013 25 cm
10-014 27 cm
Double saw



Engel Plaster Saw
10-015 15.5 cm



Serra Gigli
10-016 30 cm
10-017 40 cm
10-018 50 cm



Percy Amputation Shield
10-019 30.5cm
Handles Detachable,
Simple Pattern



Putti Bone Rasp
10-020 27cm
Double ended,
One end curved up
one end curved sideways

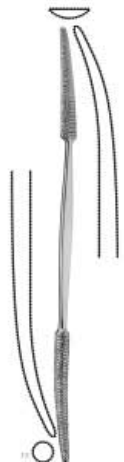

Putti Rasp
10-021 30cm
Double Ended



Putti Bone File
10-022 28cm
semicircular



Putti Bone File
Bayonet Shape
10-023 24.5cm
X=13 mm
semicircular



Putti Bone File
10-024 22cm
X=20 mm
flat



Joseph Bone Saw / Rasp
10-025 19cm
Single Sided



Linderman Amputation Saw
10-026 19cm
20cm Blade



Wellenschliff Nasal Saw
10-027 19cm
Straight



Langenbeck Metacarpal Saw
10-028 23cm
11.5cm Blade

Knochenfeilen
Limas para huesos
Limes à os
Lime per ossa



Patella Bone Saw
10-029 Includes 1 blade
10-030 Replacement blade only
 Delrin Handle



Foman Rasp
10-031 21.5cm
 Double ended, Fine & coarse serrations 4-sided convex and flat blades

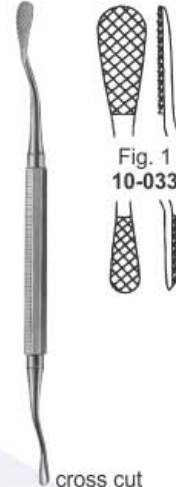

Foman Rasp
10-032 21cm



Miller-Colburn Bone File
 18 cm

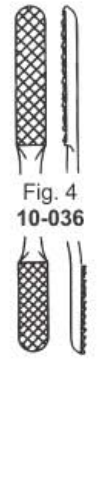
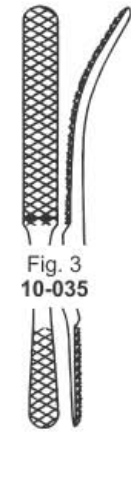
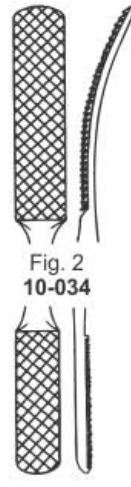

cross cut



Kleinert-Kutz Bone Rasp
10-037 22.5cm
 Double ended,
 Fine & course serrations

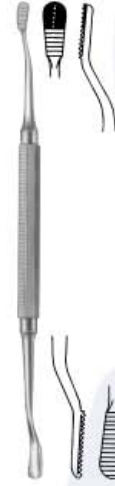

Miller Alveotomy File
10-038 19cm



Miller Alveotomy File
10-039 19cm



Gallaher Bone Rasp
10-040 18cm
10-041 25cm
 Curved



Gallaher Bone Rasp
10-042 18cm
10-043 25cm
 Convex Curve



Gallaher Bone Rasp
10-044 18cm
10-045 25cm
 Straight



Good Bone File / Rasp
10-046 16.5cm
 Straight



Kistler Ear Cartilage Rasp
10-047 left
10-048 right
 16.5cm Curved

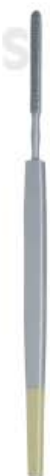

Micro Rasp
10-049 14cm
 Single ended
 double sided



Nail Rasp
10-050 17cm
 Single sided



Maltz Rasp
10-051 18cm
 Single-Ended
 Single sided



Improved Maltz Rasp
10-052 18cm
 Single-Ended,
 up & down rasping



Putti Rasp
10-053 23cm
 falt / flat
10-054 30.5cm
 Round / flat

Raspeln, Feilen
Rapes, Limes
Escofinas, limas
Raspe, lime

Miller Rasp
10-055 21.5cm
 Double Ended straight
 single Sided



Fomon Rasp
10-056 21.5cm
 Double Ended straight
 single Sided
 one side concave



Fomon Rasp
10-057 21.5cm
 Double Ended straight
 single Sided
 one side convex



Fomon Rasp
10-058 21.5cm
 Double Ended straight
 single Sided



Fomon Rasp
10-059 21.5cm
 Double Ended straight
 single Sided
 one side concave



Fomon Rasp
10-060 21.5cm
 Double Ended straight
 single Sided
 one side convex



Chisel Blade Handle
10-061 18.5cm



Chisel blades,
interchangeable

10-062 8.5cm
5mm
10-063 8.5cm
10mm
10-064 8.5cm
16mm
10-065 8.5cm
25mm



Osteotome blades,
interchangeable

10-066 8.5cm
5mm
10-067 8.5cm
10mm
10-068 8.5cm
16mm
10-069 8.5cm
25mm



Chisel Blade key
10-070 9cm



Osteotome
 13.5cm
10-071 8mm
10-072 10mm
10-073 12mm
10-074 14mm
10-075 16mm



Chisel
 13.5cm
10-076 8mm
10-077 10mm
10-078 12mm
10-079 14mm
10-080 16mm



Gouge
 13.5cm
10-081 8mm
10-082 10mm
10-083 12mm
10-084 14mm
10-085 16mm



Lucas Chisel
 16cm
10-086 3mm
10-087 4mm
10-088 5mm
10-089 6mm



Lucas Gouge
 16cm
10-090 3mm
10-091 4mm
10-092 5mm
10-093 6mm



**U.S. Army Pattern
Chisel**
 16.5 cm
10-094 6 mm wide
10-095 12 mm wide
10-096 18 mm wide



Partsch Chisel	Partsch Chisel	Partsch Chisel
11.5cm	13.5cm	17.5cm
10-097 2mm	10-103 2mm	10-109 2mm
10-098 3mm	10-104 3mm	10-110 3mm
10-099 4mm	10-105 4mm	10-111 4mm
10-100 6mm	10-106 6mm	10-112 6mm
10-101 7mm	10-107 7mm	10-113 7mm
10-102 8mm	10-108 8mm	10-114 8mm

Knochenmeißel
Ciseaux-burins, gouges

Cineles, gubias
Scalpelli, sgorbi



Partsch Gouge	Partsch Gouge	Partsch Gouge
11.5cm	13.5cm	17.5cm
10-115 2mm	10-121 2mm	10-127 2mm
10-116 3mm	10-122 3mm	10-128 3mm
10-117 4mm	10-123 4mm	10-129 4mm
10-118 6mm	10-124 6mm	10-130 6mm
10-119 7mm	10-125 7mm	10-131 7mm
10-120 8mm	10-126 8mm	10-132 8mm



Alexander Chisel
18cm

10-133 4mm
10-134 6mm
10-135 8mm
10-136 10mm
10-137 12mm
10-138 14mm



Alexander Gouge
18cm

10-139 4mm
10-140 6mm
10-141 8mm
10-142 10mm
10-143 12mm
10-144 14mm



Smith Peterson Gouge
20cm Straight

10-145 09 mm
10-146 14 mm
10-147 19 mm
10-148 25 mm

Curved

10-149 09 mm
10-150 14 mm
10-151 19 mm
10-152 25 mm



Straight

10-153 06 mm
10-154 09 mm
10-155 13 mm
10-156 16 mm
10-157 19 mm
10-158 25 mm
10-159 32 mm

Curved

10-160 06 mm
10-161 09 mm
10-162 13 mm
10-163 16 mm
10-164 19 mm
10-165 25 mm
10-166 32 mm

Smith Peterson Osteotome
20 cm



Straight

10-167 10 mm
10-168 15 mm
10-169 20 mm
10-170 25 mm

Curved

10-171 10 mm
10-172 15 mm
10-173 20 mm
10-174 25 mm

Stille Gouge
20 cm



Stille
20 cm



Stille Chisel
20 cm



10 mm
10-185



15 mm
10-186

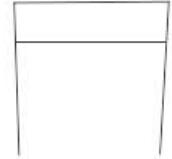

20 mm
10-187

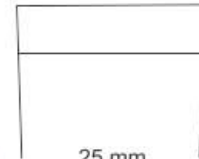

25 mm
10-188

Chisels

10-175 10 mm
10-176 12 mm
10-177 15 mm
10-178 20 mm
10-179 25 mm

Osteotome

10-180 10 mm
10-181 12 mm
10-182 15 mm
10-183 20 mm
10-184 25 mm



Stille Osteotome
20 cm



10 mm
10-189



15 mm
10-190



20 mm
10-191



25 mm
10-192



Lexter Osteotome
22 cm

10-193 7 mm
10-194 10 mm
10-195 12 mm
10-196 15 mm
10-197 20 mm
10-198 25 mm
10-199 30 mm

Lexter Modif. Osteotome
29 cm

10-200 7 mm
10-201 10 mm
10-202 12 mm
10-203 15 mm
10-204 20 mm
10-205 25 mm
10-206 30 mm



Lexter Modif. Chisel
29 cm

10-207 7 mm
10-208 10 mm
10-209 12 mm
10-210 15 mm
10-211 20 mm
10-212 25 mm
10-213 30 mm

Lexter Chisel
22 cm

10-214 7 mm
10-215 10 mm
10-216 12 mm
10-217 15 mm
10-218 20 mm
10-219 25 mm
10-220 30 mm



Lexter Gouge
25 cm

10-221 7 mm
10-222 10 mm
10-223 15 mm

Straight

*Knochenmeißel
Ciseaux-burins, gouges*
*Cineles, gubias
Scalpelli, sgorbi*

Lexer Gouge
25 cm
10-224 7 mm
10-225 10 mm
10-226 15 mm
Curved



Lexer Osteotome Flat
22 cm
10-227 10 mm
10-228 15 mm
10-229 20 mm
10-230 25 mm



Lexer Gouge Tuffnel Handle
22 cm
10-231 10 mm
10-232 15 mm
10-233 20 mm
10-234 25 mm



Mini Lexer Osteotome
10-235
18 cm



Mini Lexer Chisel
10-236
18 cm



Capener Osteotome With Tuffnel Handle
25cm
10-237 10mm
10-238 12mm
10-239 15mm
10-240 20mm
10-241 25mm
10-242 30mm
Straight



Capener Osteotome With Tuffnel Handle
25cm
10-243 10mm
10-244 12mm
10-245 15mm
10-246 20mm
10-247 25mm
10-248 30mm
Curved



Capener Chisels With Tuffnel Handle
25cm
10-249 6mm
10-250 8mm
10-251 10mm
10-252 12mm
10-253 15mm
10-254 20mm
10-255 25mm
10-256 30mm
Straight



Capener Osteotome With Tuffnel Handle
25cm
10-257 6mm
10-258 8mm
10-259 10mm
10-260 12mm
10-261 15mm
10-262 20mm
10-263 25mm
10-264 30mm
Curved



Raspatories
10-265 20cm
Medium straight blade
round edge, width 14mm



Raspatories
10-266 20cm
Large straight blade
round edge, width 20mm



Raspatories
10-267 20cm
Medium curved blade
round edge, width 14mm



Raspatories
10-268 20cm
Large curved blade
round edge, width 20mm



Mini Lexer Osteotome
10-269 20cm
18mm



Raspatories
10-270
28cm



Raspatories
10-271
28cm



Chisel
10-272
115mm/280mm
for extraction of cement

Knochenmeißel
Ciseaux-burins, gouges

Cineles, gubias
Scalpelli, sgorbi



Chisel
10-273
for extraction
of cement 9mm
Positive 400mm



Chisel
10-274
with 2 prong



**Lambotte
Osteotome**
25cm
10-275 6mm
10-276 8mm
10-277 10mm
10-278 13mm
10-279 15mm
10-280 20mm
10-281 25mm
10-282 30mm
10-283 38mm
10-284 44mm
10-285 50mm
Straight



**Lambotte
Osteotome**
25cm
10-286 6mm
10-287 8mm
10-288 10mm
10-289 13mm
10-290 15mm
10-291 20mm
10-292 25mm
10-293 30mm
10-294 38mm
10-295 44mm
10-296 50mm
Curved



**Mini-Lambotte
Osteotome**
12.5cm
10-297 3mm
10-298 4mm
10-299 6mm
10-300 8mm
10-301 10mm
10-302 12mm
10-303 15mm
Straight



**Mini-Lambotte
Osteotome**
17cm
10-304 3mm
10-305 4mm
10-306 6mm
10-307 8mm
10-308 10mm
10-309 12mm
10-310 15mm
Straight



Lambotte Osteotome
12.5cm, Straight
10-311 2mm tip width
10-312 4mm tip width
10-313 6mm tip width
10-314 8mm tip width
10-315 10mm tip width
10-316 12mm tip width
10-317 15mm tip width



Hex Handle Osteotome
15cm, Straight
10-318 2mm tip width
10-319 3mm tip width
10-320 4mm tip width
10-321 5mm tip width
10-322 6mm tip width
10-323 7mm tip width
10-324 9mm tip width
10-325 10mm tip width



Cottle Osteotome
18.5cm, Straight
10-326 4mm tip width
10-327 6mm tip width
10-328 9mm tip width
10-329 12mm tip width



**Anderson-Nievert
Osteotome**
20.4cm
10-330 Curved right
10-331 Curved left
10-332 Straight

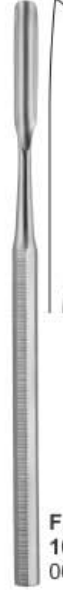

Freer Gouge
10-333 15cm
06mm



Freer Chisel
10-334 16cm
04mm



**Shoulder
Penetrating Gouge**
10-335 21.6cm
Straight, 3mm distal tip



**Ballenger
Chisel** 16cm
10-336
4mm
10-337
6mm
10-338
8mm



**Mannerfelt
Modif.**



Osteotomes
10-339 4mm
10-340 6mm
10-341 8mm
15.5cm



Gouge
10-342
4mm
15.5cm



**Kilian,
Septum Gouge**
10-343 16cm
5mm



**Kilian-Claus
Septum Gouge**
10-344 16cm
5mm

Knochenmeißel
Ciseaux-burins, gouges

Cineles, gubias
Scalpelli, sgorbi



Stille
20cm



Stille Chisel
10-345 10mm
10-346 15mm
10-347 20mm
10-348 25mm
Straight



Stille Osteotome
10-349 10mm
10-350 15mm
10-351 20mm
10-352 25mm
Straight



Stille Osteotome
10-353 10mm
10-354 15mm
10-355 20mm
10-356 25mm
Curved



Stille Gouge
10-357 10mm
10-358 15mm
10-359 20mm
10-360 25mm
Straight



Stille Gouge
10-361 10mm
10-362 15mm
10-363 20mm
10-364 25mm
Curved



Smith-Petersen
20cm 8"



Smith-Petersen osteotome
10-365 6mm
10-366 9mm
10-367 13mm
10-368 16mm
10-369 19mm
10-370 25mm
10-371 32mm
Straight



Smith-Petersen Osteotome
10-372 6mm
10-373 9mm
10-374 13mm
10-375 16mm
10-376 19mm
10-377 25mm
10-378 32mm
Curved



Smith-Petersen Gouge
10-379 9mm
10-380 16mm
10-381 19mm
10-382 25mm
Straight



Smith-Petersen Gouge
10-383 9mm
10-384 16mm
10-385 19mm
10-386 25mm
Curved



Hoke Osteotome
14cm
10-387 3mm
10-388 5mm
10-389 7mm
10-390 8.5mm
10-391 10mm
10-392 12mm



Hibbs
24cm



Hibbs Osteotome
10-393 6mm
10-394 13mm
10-395 19mm
10-396 25mm
10-397 32mm
Straight



Hibbs Chisel
10-398 6mm
10-399 13mm
10-400 19mm
10-401 25mm
10-402 32mm
Straight



Hibbs Osteotome
10-403 6mm
10-404 13mm
10-405 19mm
10-406 25mm
10-407 32mm
Curved



Hibbs Gouge
10-408 6mm
10-409 13mm
10-410 19mm
10-411 25mm
10-412 32mm
Straight



Hibbs Gouge
10-413 6mm
10-414 13mm
10-415 19mm
10-416 25mm
10-417 32mm
Curved

Knochenmeißel
Ciseaux-burins, gouges

Cineles, gubias
Scalpelli, sgorbi

Cottle Osteotome
10-418 7mm
10-419 12mm
15cm

Cottle Osteotome
10-420 19cm
04mm

Cottle Osteotome with depth markings
10-421 18cm
06mm

Fomon Chisel
17cm

10-422 04mm
10-423 07mm
10-424 05mm
10-425 08mm
10-426 06mm

Cinelli Chisel
18cm

10-427 10mm
10-428 12mm
10-429 14mm
10-430 16mm

Cottle Osteotome
18cm

10-431 04mm
10-432 09mm
10-433 07mm
10-434 12mm

Cottle Osteotomes
10-435 18cm
16mm Protected and depth markings

Cottle Chisel
18cm

10-436 04mm
10-437 09mm
10-438 07mm
10-439 12mm

Cottle Osteotomes
10-440 18cm
06mm Cross bar and depth markings

Cottle Osteotomes
10-441 18cm
16mm Cross bar and depth markings

Hoke Osteotome
13.5cm
Curved

10-442 3mm tip width
10-443 4mm tip width
10-444 6mm tip width
10-445 8mm tip width
10-446 10mm tip width
10-447 13mm tip width
10-448 16mm tip width
10-449 19mm tip width

Walter Gouge
19cm

10-450 3mm
10-451 4.5mm

Cottle Osteotome
10-452 4mm
10-453 9mm
10-454 7mm
10-455 12mm
20cm

Rubin osteotome with stabilizer to reduce chance of twisting for more control
10-456 10mm
10-457 12mm
10-458 14mm
18cm

Silver Rhinoplastic Chisel
10-459 18cm Straight
10-460 18cm right
10-461 18cm Left

Neivert-Anderson osteotome
10-462 20cm Straight
10-463 20cm right
10-464 20cm Left

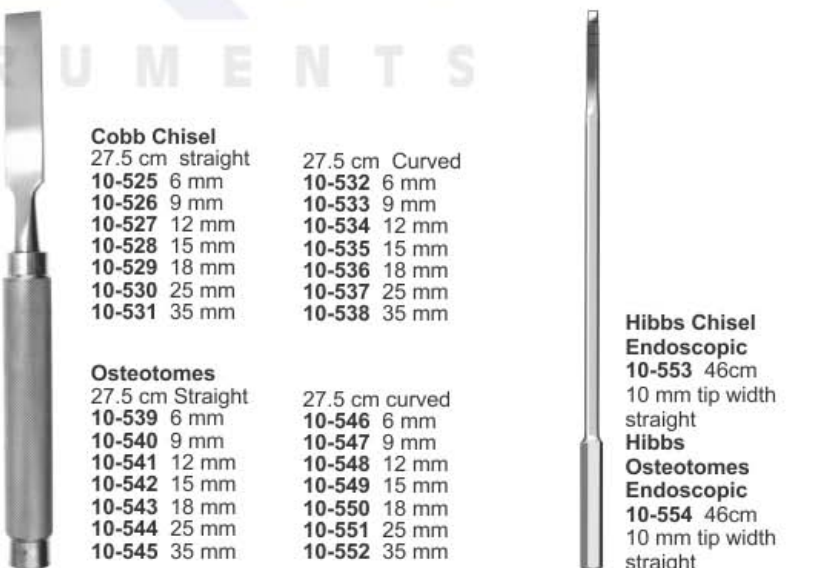
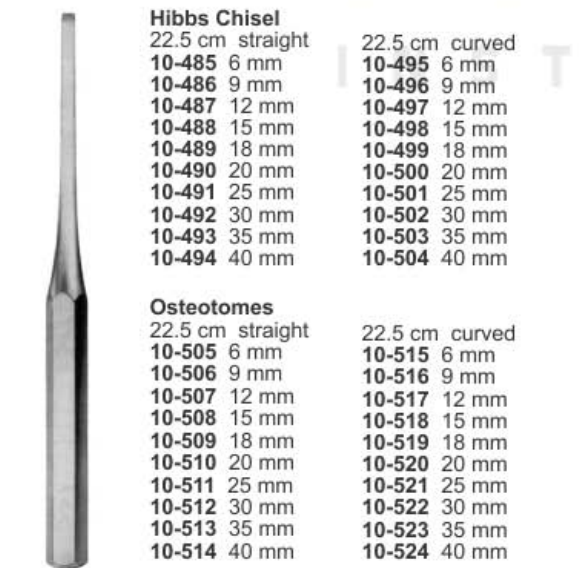
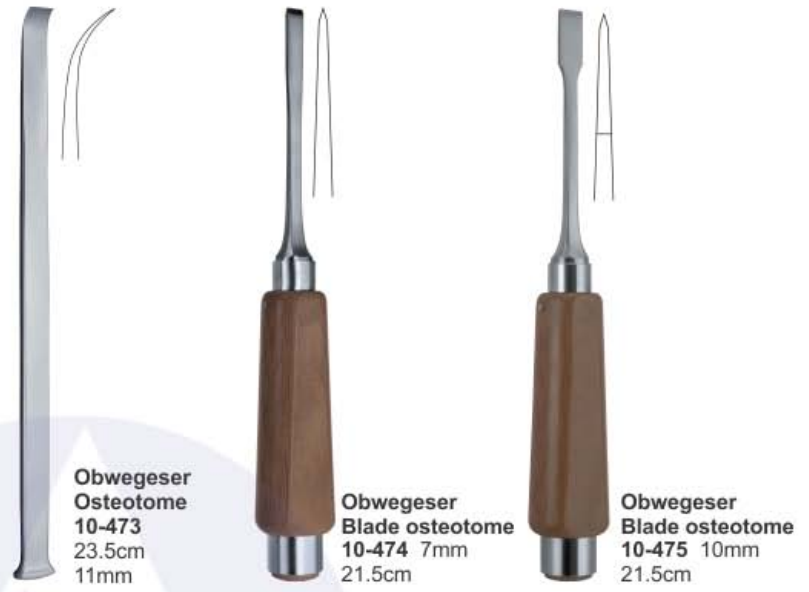
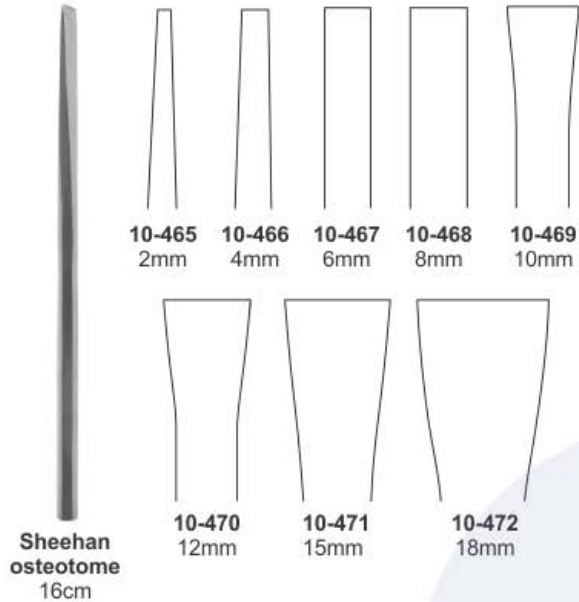

Hibbs Chisel / Osteotomes

Cobb Chisel / Osteotomes

Hammer
Maillets

Martillos
Martelli



Doyen Mallets
25cm
10-555
25mmØ - 120g
10-556
30mmØ - 180g
10-557
35mmØ - 260g



Collin Mallets
10-558
20cm
30mmØ - 220g



Hajek Mallets
10-559
21.5cm
27mmØ - 140g



Kirk Mallets
10-560 19cm
38mmØ - 750g
10-561 20.4cm
Head diameter
38.0mm,
Weight: 1 lb. 4 oz.
570 grams



Partsch Mallets
10-562 18cm
22mmØ - 200g



Lucae Mallets
10-563
19mmØ - 220g
10-564
25mmØ - 260g
19cm



Mallet Mallets
10-565 19cm
250mmØ - 205g
Solid steel, with
plastic faces



Cottle Mallets
10-566
18.5cm
30mmØ - 240g
1 side flat /
1 side convex



Williger Hammer
10-567 250g
10-568 350g



Neufield Hammer
10-569



**Solid Copper
Head Mallet**
10-570 16.5cm
Solid, Head
diameter
20mm



Nylon Head Mallet
10-571 19cm
Head diameter 25.4mm,
7.76 oz.
10-572 19.5cm
Head diameter 3cm
Weight 11 oz.



**Extra 3cm Nylon Face
FOR 10-572**
10-573 Head diameter
3cm



Combination Mallet
10-574 19.5cm
Solid, Head
diameter 32.0mm,
Weight 12 oz 340
grams, Head weight:
8 oz 227 grams

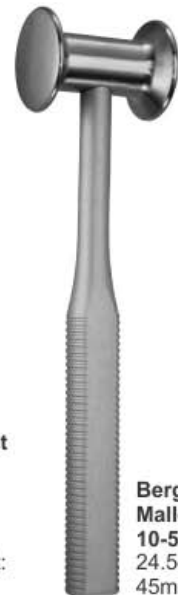

**Bergmann
Mallets**
10-575
24.5cm
45mmØ - 300g

Hammer
Maillets

Martillos
Martelli



Ombredanne Mallets
10-576
24cm
40mmØ - 550g



Heath Mallets
10-577 18cm
40mmØ - 700g
10-578 20cm
45mmØ - 1000g



Williger Mallets
10-579
28mmØ - 340g
10-580
30mmØ - 400g
24cm
Lead filled



Hajek Hammer
10-581 250gm
10-582 500gm



Universal Hammer
10-583 500gm
10-584 750gm



Mallet, Lightweight
10-585 19cm
Stainless Steel and Aluminum
Head diameter 25.0mm
Weight 7 oz 200 grams
Head Weight: 4 oz 113 grams



Nylon Caps Left & Right
FOR 10-585 (PAIR)
10-586
2.5cm



Mallet #49
10-587 19.5cm
Head diameter
22.0mm
Weight 7 oz 200
grams
Head Weight:
5oz/150 grams



Mead Mallet
10-588 19cm
Head diameter
26.0mm
Weight 11 oz 315
grams
Head Weight:
6 oz 170 grams



Heath Mallet, Heavyweight
10-589 19cm
Head diameter
40.0mm
Weight 2 lbs.
(907 grams)
Head Weight:
20 oz (567 grams)



Orthopedic Mallet
10-590 27.5cm
Lightweight
Solid, Head
diameter 35.0mm
Weight 2 lbs.
(907 grams)
Head Weight:
1 lb. (454 grams)



Orthopedic Mallet
10-591 28cm
Heavyweight
Solid, Head
diameter 50.0mm
Head Weight:
2 lb. (900 grams)



Ortho Mallets
10-592
26.5cm
(450g)



Nylon Cap
10-593
For Phenolic Handle Mallet

Phenolic Handle Mallet
10-593 28 cm
Head diameter 32mm
Head weight 16 oz (454 grams)
10-594 Head diameter 45mm
Weight 11 oz (312 grams);
Head weight: 2 lbs (907 grams),

Hammer
Maillets

Martillos
Martelli



Reprocussion Free Mallet
Cap For 10-596

Reprocussion Free Mallet
10-595 28cm
Head diameter 30mm
Weight 1lb 5 oz (595 grams)
ead weight: 10 oz (283 grams)



Mallet
10-597 26cm
Plane (Nylon)
convex (steel)
Head 30mm Ø
weight 675 grams.



Mallet
10-598 26cm
Head 42/30mm Ø
weight 530 grams



Mallet
10-599 26cm
Plastic Handle
head 30mm Ø
weight 510 grams



Vickers Mallets
10-600 19 cm
25mmØ - 300g
nylon disks plastic



Herbert Mallets
10-601 19 cm
25mmØ - 300g
for ulnar head
prosthesis plastic
handle



Mallet
10-602 18cm
Made of Plastic
Head 30mm Ø
weight 125 grams



Mallet
10-603 26 cm
Made of Plastic
with lead filling
Head 42mm Ø
weight 250 grams



Mallet
10-604 22.5 cm
Disks & Plastic Handle
Head 37mm Ø
weight 370 grams



Mallet
26 cm
Made of Plastic
with lead filling
10-606
Head 42 mm Ø
weight 400 grams
10-607
Head 42 mm Ø
weight 250 grams



Mallet
10-608 24cm
Plastic Handle
Head 30mm Ø
weight 480
grams



Mallet
10-609



Mallet
10-610



Mallet
10-611



Mallet
10-612

Raspatorien, Stobel
Periostótomos, Pílons

Rugines-raspatoires, Punzones
Periostotomi, Pestoni



10-613 12 mm
10-614 19 mm
10-615 25 mm
10-616 32 mm

Cobb Spinal Elevator
23.8 cm sharp
with hexagonal handle



Harrington Spinal Elevator
10-617 30cm
19 mm tip width
Sharp

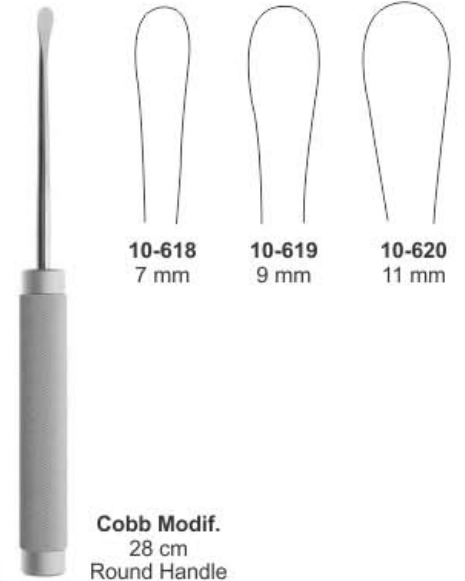

10-618 7 mm
10-619 9 mm
10-620 11 mm

Cobb Modif.
28 cm
Round Handle



10-621 4 mm
10-622 6 mm
10-623 8 mm

Cobb Modif.
28 cm
Round Handle



10-624
17.5 cm

Sebileau Periosteal Elevator



10-625
15.5cm
Head diameter
2mm

10-626
15.5cm
Head diameter
3mm

10-627
15.5cm
Head diameter
4mm

10-628
15.5cm
Head diameter
5mm

10-629
15.5cm
Head diameter
6mm

10-630
15.5cm
Head diameter
8mm

10-631
15.5cm
Head diameter
10mm

Bone Tamper



10-632
2.5mm x 2.5mm

10-633
3.5mm x 3.5mm

Passow Bone Tamper
12cm



10-634
3mm

10-635
5mm

10-636
8mm

Caspar Bone Tamper
20cm



10-637
12mm

10-638
14mm

10-639
16mm

Caspar Bone Tamper
20cm



Tip Size
2 mm
3 mm
4 mm
5 mm
6 mm
8 mm
10 mm

Bone Tamps
10-640
15.4 cm

Scharfe Löffel
Curettes tranchantes

cucharillas cortantes
Cucchiai taglienti



**Volkman
Bone Curette**

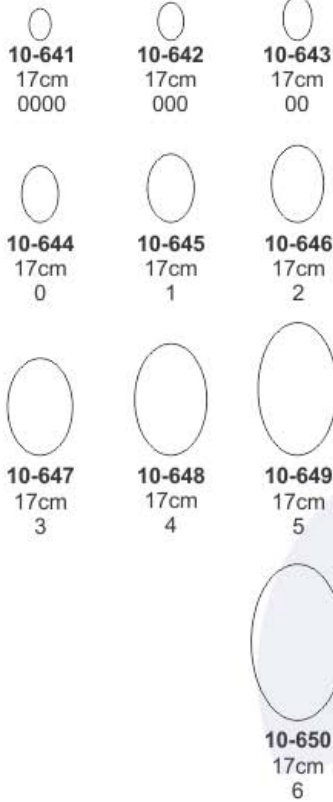

**Schede
Bone Curette
17cm**

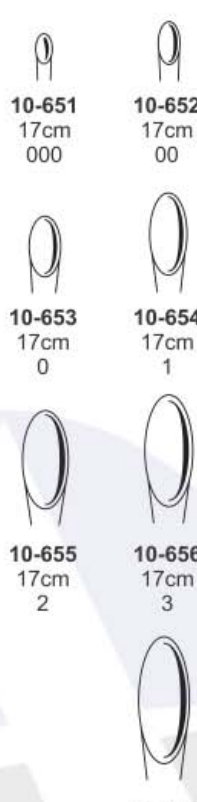

**10-657
17cm
4**



**Bruns
Bone Curette**

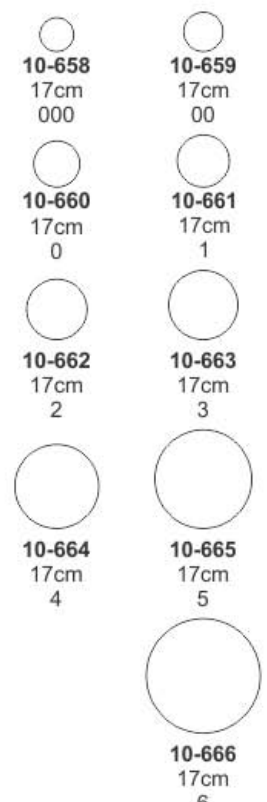

**Spratt Bone Curette
/ Hollow Handle**



**Halle Bone Curette
Flexible**



**Uffendorde Bone
Curette Left
10-680 17.5cm**



**Uffendorde Bone
Curette Right
10-681 17.5cm**

Scharfe Loffel
Curettes tranchantes

cucharillas cortantes
Cucchiai taglienti



**Bruns Bone
Curette 23 cm**

- Fig.1
10-682
- Fig.2
10-683
- Fig.3
10-684
- Fig.4
10-685
- Fig.5
10-686
- Fig.6
10-687
- Fig.7
10-688
- Fig.8
10-689
- Fig.9
10-690



**Bone Curette
Straight**

- 10-691
20cm
000
- 10-692
20cm
00
- 10-693
20cm
0
- 10-694
20cm
1
- 10-695
20cm
2
- 10-696
20cm
3
- 10-697
20cm
4
- 10-698
20cm
5
- 10-699
20cm
6



**Bone Curette
Curved**

- 10-700
20cm
000
- 10-701
20cm
00
- 10-702
20cm
0
- 10-703
20cm
1
- 10-704
20cm
2
- 10-705
20cm
3
- 10-706
20cm
4
- 10-707
20cm
5
- 10-708
20cm
6



**Schroeder
Bone Curette
Sharp / rigid**

- 10-709
30cm
1
- 10-710
30cm
2
- 10-711
30cm
3
- 10-712
30cm
4
- 10-713
30cm
5
- 10-714
30cm
6



**Simon
Bone Curette
Sharp / rigid**

- 10-715
24cm
0000
- 10-716
24cm
000
- 10-717
24cm
00
- 10-718
24cm
0
- 10-719
25cm
1
- 10-720
25cm
2
- 10-721
25cm
3
- 10-722
25cm
4
- 10-723
25cm
5
- 10-724
25cm
6

Scharfe Löffel
Curettes tranchantes

cucharillas cortantes
Cucchiai taglienti



- 10-725
3.6mm
000
- 10-726
4.4mm
00
- 10-727
5.2mm
0
- 10-728
6.8mm
1

Bone Curette
25 cm
Straight



- 10-729
2.8mm
0000
- 10-730
3.6mm
000
- 10-731
4.4mm
00
- 10-732
5.2mm
0

Daubenspeck Bone Curette
20 cm



- 10-733
Straight
- 10-734
Down Angle
- 10-735
Up Angle

Scoville Bone Curette
25 cm



- 10-736
1.8mm
00000
- 10-737
2.0mm
0000
- 10-738
2.4mm
000
- 10-739
2.6mm
00
- 10-740
2.8mm
0

Lempert Bone Curette
21.5 cm



- 10-741
5 mm
- 10-742
7 mm
- 10-743
9 mm
- 10-744
10 mm
- 10-745
12 mm

Cushing Bone Curette
23.5 cm
Pituitary Spoon,
malleable, silver-plated



- 10-746
4 mm x 10 mm
straight
- 10-747
4 mm x 10 mm
up angle
- 10-748
4 mm x 10 mm
down angle

Scoville Bone Curette
25 cm
Ruptured Disc Curette



- 10-749
Ø 4 mm
straight
- 30°
10-750 Ø 3 mm
10-751 Ø 4 mm
10-752 Ø 5 mm
- 45°
10-753 Ø 3 mm
10-754 Ø 4 mm
10-755 Ø 5 mm

Tay-Bronson Bone Curette
22 cm
Pituitary Curette, double-edged

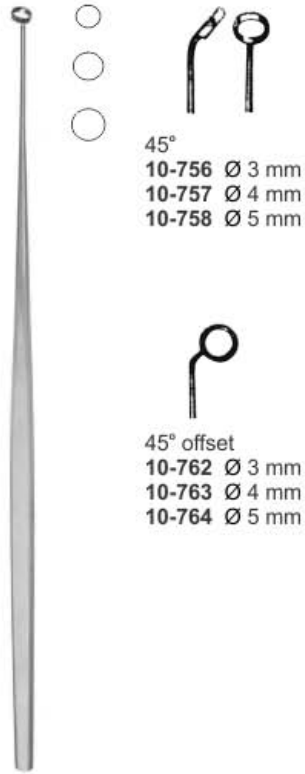

45°
10-756 Ø 3 mm
10-757 Ø 4 mm
10-758 Ø 5 mm

45° offset
10-762 Ø 3 mm
10-763 Ø 4 mm
10-764 Ø 5 mm

90°
10-759 Ø 3 mm
10-760 Ø 4 mm
10-761 Ø 5 mm

90° offset
10-765 Ø 3 mm
10-766 Ø 4 mm
10-767 Ø 5 mm



**Volkmann
Curette**
Oval / Oval

10-768
13cm

10-769
14cm

10-770
17cm



**Volkmann
Curette**
Round / Oval

10-771
13cm

10-772
16cm

10-773
20cm

Ray Bone Curette, 19 cm
Pituitary Curette



Curette
10-774
21cm
round / oval



**Martini
Curette**
13.5cm

- 10-775 00
- 10-776 0
- 10-777 0
- 10-778 1
- 10-779 1
- 10-780 2



**Martini
Curette**
15.5cm

- 10-781 00
- 10-782 0
- 10-783 1



**Williger
Curette**
13.5cm

- 10-784 00
- 10-785 0
- 10-786 0
- 10-787 1
- 10-788 1
- 10-789 2



**Williger
Curette**
15.5cm

- 10-790 00
- 10-791 0
- 10-792 1

Scharfe Löffel
Curettes tranchantes

cucharillas cortantes
Cucchiai taglianti

↑ ↓
10-796 13cm
Double Ended
6.2 mm & 6.7 mm

↑ ↓
10-797 16cm
Double Ended
7 mm & 9 mm

↑ ↓
10-798 20cm
Double Ended
9.1 mm & 11.1 mm

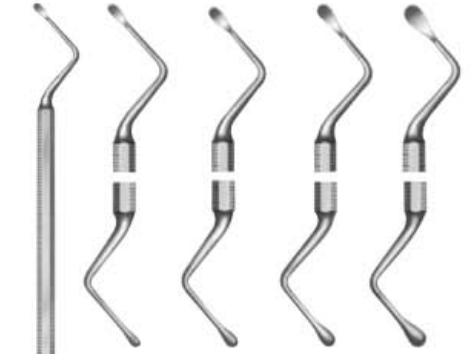

Fig. 1 R/L 10-799 Fig. 2 R/L 10-800 Fig. 3 R/L 10-801 Fig. 4 R/L 10-802



Jansen Curette
10-793 16cm



Jansen Curette
10-794 15cm



Williger Curette
10-795 13.25cm
Double Ended 00/0



Curette

Lucas Curette
double-ended
18cm

PERIOSTEAL ELEVATORS



Obwegeser
Elevator



10-803
17cm
6 mm



10-804
17cm
7 mm



10-805
17cm
9 mm



10-806
17cm
11 mm



10-807
20cm
5 mm



10-808
20cm
8 mm



10-809
20cm
9 mm



Obwegeser-
Freer
Elevator
10-810 21cm

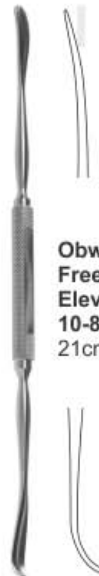

Obwegeser-
Freer
Elevator
10-811
21cm



Sachs Nerve
elevator
10-812
18.5cm
3 mm blunt



Kleinert Kutz
Elevator and
Dissector
10-813
19.5cm
2 mm x 3 mm
Sharp ends



Freer Elevator
10-814 18.5cm
double ended
5 mm sharp end
5 mm blunt end

Raspatorien
Periostótomos

Rugines-raspatoires
Periostotomi

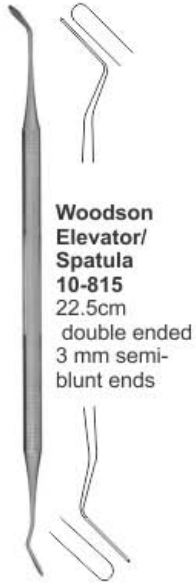

**Woodson Elevator/
Spatula
10-815**
22.5cm
double ended
3 mm semi-
blunt ends



**Woodson Dural
Separator/Packer
10-816** 17.5cm
double ended with
grooved
blade 3 mm blunt
end

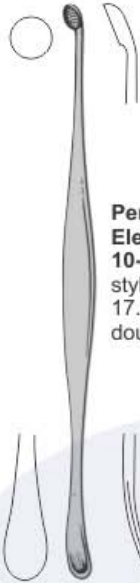

**Penfield
Elevators
10-817**
style #1
17.5 cm
double ended

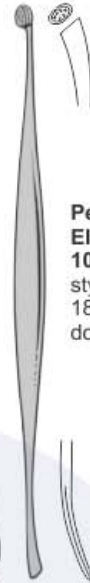

**Penfield
Elevators
10-818**
style #2
18.5 cm
double ended

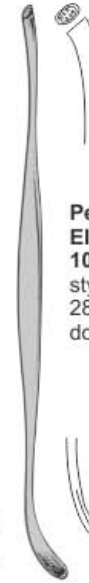

**Penfield
Elevators
10-819**
style #3
28 cm
double ended



**Penfield
Elevators
10-820**
style #4
28 cm
single
ended

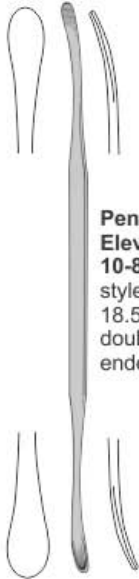

**Penfield
Elevators
10-821**
style #5
18.5 cm
double
ended



**Alderdyce
Elevators
10-822**
21.5 cm
double
ended

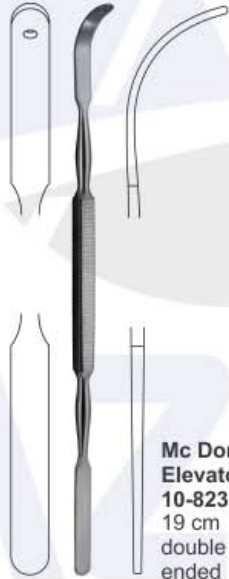

**Mc Donald
Elevators
10-823**
19 cm
double
ended

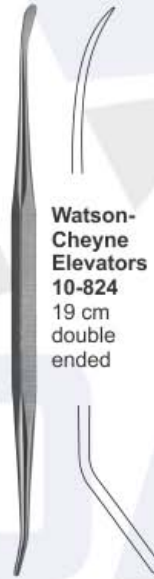

**Watson-
Cheyne
Elevators
10-824**
19 cm
double
ended



**Obwegeser
Needle
10-825**
17.5cm



**Obwegeser
Needle
10-826**
23cm



**Obwegeser
Needle
10-827**
18cm



**Obwegeser
Needle
10-828**
14cm



Doyen Rib Raspatory
17cm



10-829
Right Crved
For Adults



10-830
Right Crved
For Children



Doyen Rib Raspatory
17cm



10-831
Left Crved
For Adults



10-832
Left Crved
For Children



**Sedillot
Elevator
10-833**
18.5cm
10-834
21cm

Raspatorien
Periostótomos

Rugines-raspatoires
Periostotomi



Crego Periosteal Elevator 10-835
15.5cm



Williger Elevator 10-836
13cm
5mm



Williger Elevator 10-837 4mm
10-838 6mm
16cm

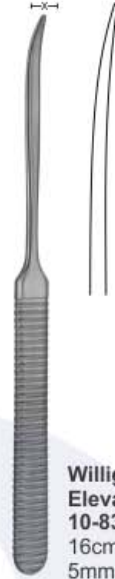

Williger Elevator 10-839
16cm
5mm

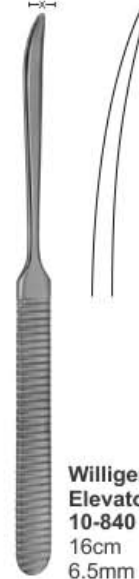

Williger Elevator 10-840
16cm
6.5mm

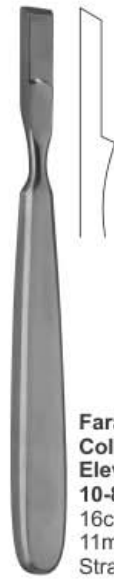

Farabeuf-Collin Elevator 10-841
16cm
11mm
Straight



Farabeuf-Collin Elevator 10-842
16cm
11mm
Curved



Farabeuf Elevator 10-843
15cm
Straight



Farabeuf Elevator 10-844
15cm
Curved



Lambotte Elevator 10-845 5mm
10-846 10mm
10-847 15mm
10-848 20mm
10-849 25mm
21cm Straight

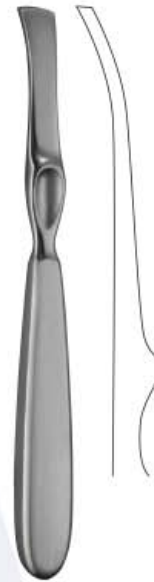

Lambotte Elevator 10-850 5mm
10-851 10mm
10-852 15mm
10-853 20mm
10-854 25mm
21cm Curved



Adson Elevator

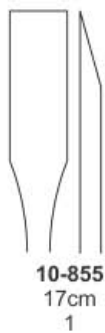

10-855
17cm
1

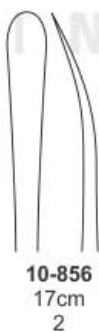

10-856
17cm
2



10-857
17cm
3

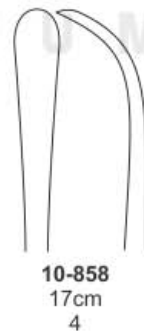

10-858
17cm
4



Quervain Elevator 10-859
06mm
19.5cm



Trelat Elevator 10-860
8mm
15cm

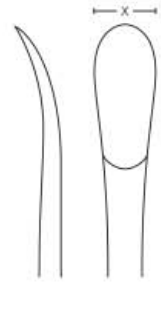

Raspatorien
Periostótomos

Rugines-raspatoires
Periostotomi

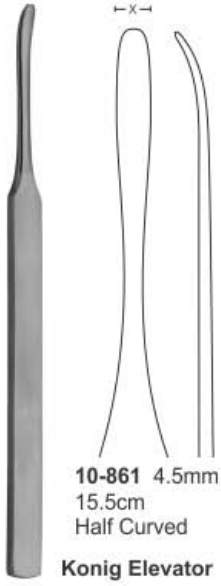

10-861 4.5mm
15.5cm
Half Curved
Konig Elevator

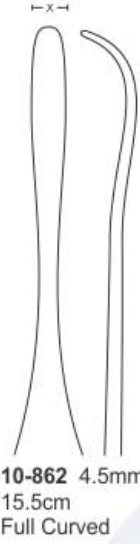

10-862 4.5mm
15.5cm
Full Curved



10-863
15cm
2.5mm

10-864
15cm
2.5mm

Obwegeser Elevator



Obwegeser Elevator 10-865
18.5cm



Obwegeser - Freer Osteotome Elevator 10-866
18.5cm



Howarth Periosteal Elevator 10-867
21.5cm
Sharp / Blunt



Langen-Beck Periosteal Elevator 10-868
18cm



Langen-Beck Periosteal Elevator 10-869
19cm



Alexander Periosteal Elevator 10-870
20cm



Periosteal Elevator 10-871
17 cm



10-872
8 mm



Semb Periosteal Elevator



10-873
17.5cm
12mm



10-874
21cm
12mm



10-875
17.5cm
12mm



10-876
21cm
13mm



10-877
22.5cm
13mm



10-878
22.5cm
15mm

I N S T R U M E N T

Raspatorien
Periostótomos

Rugines-raspatoires
Periostotomi

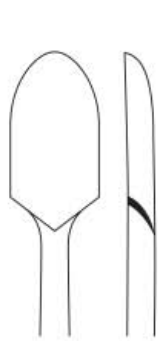

10-879
14mm
Straight
1

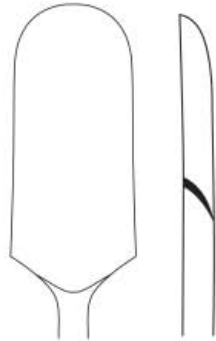

10-880
20mm
Straight
3

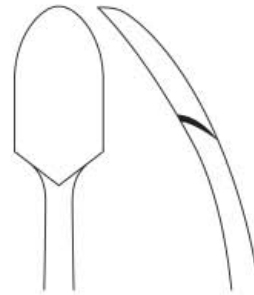

10-881
14mm
Curved
2

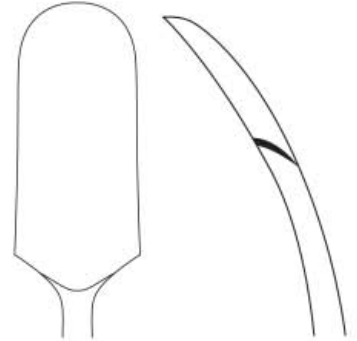

10-882
20mm
Curved
3

Ferozell Periosteal Elevator
20cm

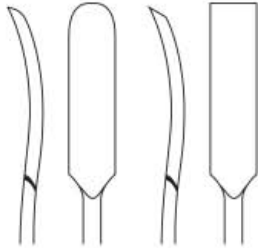

10-883
6mm
1

10-884
3mm
2

10-885
6mm
3

Ferozell Periosteal Elevator
18cm



Periosteal
Raspatories
10-886
18.5cm
cvd



Periosteal Elevator
10-887 18cm
Fiber/Phenolic Handle
blade 6mm



Hoen Periosteal Elevator
10-888
16.5cm



Chandler Bone Elevator
10-889 19cm
13 mm
10-890 20cm
20 mm
10-891 23cm
25 mm
10-892 25cm
31 mm



Key Periosteal Elevator 19cm
10-893
6 mm
10-894
12 mm
10-895
20 mm
10-896
25 mm
sharp,
slightly
curved



Pennybacker Periosteal Elevator
10-897
6 mm
17 cm sharp,
curved



Langenbeck Periosteal Elevator
10-898
15 mm
19 cm
sharp, slightly
curved



Cushing Periosteal Elevator 15 mm
10-899
Round Edge
10-900
Square Edge
18 cm

Raspatorien
Periostótomos

Rugines-raspatoires
Periostotomi



Hoen Periosteal Elevator
10-901 7mm, 16cm
10-902 15mm, 19cm
10-903 20mm, 19cm
Semisharp



Sayre Periosteal Elevator
10-904 17cm
one straight blunt
and one curved
sharp



Langenbeck Periosteal Elevator
10-905 7mm
10-906 10mm
20 cm Blunt



Cushing Periosteal Elevator
19cm
10-907
Left
10-908
Right



Cobb Periosteal Elevator
10-909 10mm
10-910 13mm
10-911 19mm
29cm
Spinal Raspatory

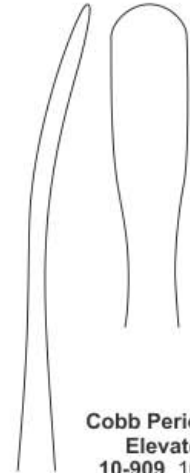

Key Periosteal Elevator

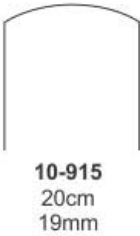

Cobb Periosteal Elevator
10-917 23.4cm
Hex Handle



Darrach Elevator
10-918 26cm
19mm
10-919 35cm
25.4mm
Blunt, Slightly
Curved



Carroll Periosteal Elevator
10-920 14cm
sharp, double ended
3 mm round end,
10 mm flat end



Langenbeck Periosteal Elevator
19.5cm
10-921
blunt edge
10-922
sharp edge



Key Periosteal Elevator sharp edge
10-923 17.7 cm 6.5 mm width
10-924 18.5 cm 9.5 mm width
10-925 18.5 cm 12.7 mm width
10-926 20.0 cm 19.0 mm width
10-927 20.9 cm 25.0 mm width



Lane Bone Elevator
10-928
16cm
Serrated



Lane Bone Elevator
10-929
27cm



Trethowan's Bone Elevator
10-930
22cm



Bristow's Bone Lever
10-931
24cm

I N S T R U M E N T S

Raspatorien, Meniskotome
 Periostótomos, Bistouries a meniscos

Rugines-raspatoires, Bisturies para meniscos
 Periostotomi, Bisturi per menisco



St. Thomas
10-932
 16cm
 Pointed



St. Thomas
10-933
 16cm
 Rounded



Robinson's
10-934
 17cm



Freer D
Septum
Knife
10-935
 15cm



Bircher
Meniscotomy
Knife
10-936
 19cm



Matson
Meniscotomy
Knife
10-937
 22cm



Downing
Cartilage
Knife
10-938
 25.5cm
 Curved tip,
 Straight shaft



Smillie
Meniscotomy
Knife
10-939 16cm
 Straight Shaft
 Blade tip width
 is 7.8mm
 Straight tip



Smillie
Meniscotomy
Knife
10-940 16cm
 Curved Shaft
 Blade tip width
 is 7.8mm
 Curved left tip



Kanadisches
Modell
Meniscotomy
knife
10-941
 20cm



Kanadisches
Modell
Meniscotomy
knife
10-942
 20cm

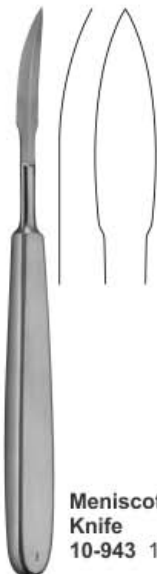

Meniscotomy
Knife
10-943 18cm



Neff Meniscotomy
Knife



10-944
 22cm
 left

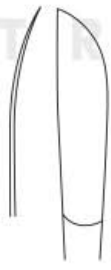

10-945
 22cm
 right



Bunnell Tendon
Strippers
 23cm
 Malleable shaft



10-946
 4mm



10-947
 4.5mm



10-948
 5.5mm



Bunnell
Tendon
Strippers
 15.2cm

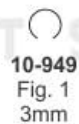

10-949
 Fig. 1
 3mm

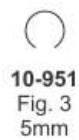

10-951
 Fig. 3
 5mm

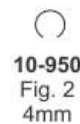

10-950
 Fig. 2
 4mm



10-952
 Fig. 4
 6mm



10-953
 Fig. 5
 7mm



Fischer
Tendon
Strippers
10-954
 31cm

Sehnenstripper, Knochenhebel
enucleadores de tendones, Elevadores para huesos
Instruments a ecorcher les tendons, Leviers a os
Scollatendini, Elevatori per ossa

Bunnell Tendon Strippers
10-955 23cm
Tendon passer



Kleinert-Kutz Tendon Retriever
10-956
20cm
Serrated



Kleinert-Kutz Tendon Retriever
10-957
20cm
Serrated,
flexible shaft



Brand Tendon Tunelling Forceps
10-958 15cm
10-959 19cm
10-960 24cm
Straight, serrated
2 x 3 teeth



Hohmann Bone Elevator
10-961 43mm
24.5 cm



Hohmann Bone Elevator
10-962 22mm
26cm



Hohmann Bone Elevator
10-963 33mm
28cm



Hohmann Bone Elevator
10-964 24mm
26.5cm



Hohmann Bone Elevator
10-965 22mm
26cm



Capsule Retractor
10-966 25.5cm
3 sharp-pronged,
22mm width blade



Bristow-Bankart Humeral Retractor
10-967 19cm
Double-pronged,
25mm width x 102mm
depth blade



Bristow-Bankart Soft Tissue Retractor
10-968 20cm
3-pronged
21mm width blade,



Humeral Head Retractor
10-969 22cm
18mm width blade



Hohmann Bone Elevator
10-970 22cm
08mm width blade
10-971 23cm
10mm width blade



Hohmann Bone Elevator
10-972 24cm
18mm



Hohmann Bone Elevator
10-973 24cm 70mm
10-974 28.5cm 35mm width blade
10-975 33cm 40mm width blade



**Hohmann Long
Shank Retractor**
10-976 23cm
43mm width blade



**Mini-Hohmann
Bone Elevator**

10-977 16cm
6mm width
blade



10-978 16cm
8mm width
blade



**Hohmann
Bone Lever**
10-979
15cm



**Hohmann
Bone Lever**
10-980
15.4cm
Short tip



**Hohmann
Retractor**
10-981
15cm
15mm width
blade



**Hayes Hand
Retractor**
10-982
16cm
3mm width
blade



**Hayes Hand
Retractor**
10-983
15cm
6mm width
blade



Bone Lever



10-984
14cm
2.8mm



10-985
14cm
4.5mm



10-986
14cm
6mm



**Bristow Bone
Lever**
10-987
23cm



**Lane Bone
Lever**
10-988
21cm



Periosteal Elevator 17.5cm
For Metacarpals Small
10-989 6 mm width
For Metacarpals Medium
10-990 10 mm width
Light Curve, Rounded End,
10-991 5 mm width
Contra Angled Curve
10-992 4.5 mm width

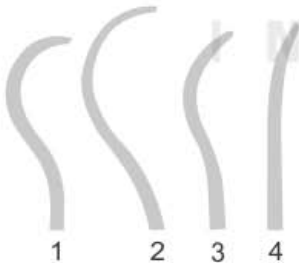

Hohmann Retractor
10-993 18cm
Small, width 6 mm
short, narrow tip



Hohmann Retractor
10-994 18cm
Small, width 8 mm
short, narrow tip



Hohmann Retractor
10-995 12.5cm
Finger Ring handle,
16mm width blade



Hohmann-Williger Retractor
10-996
 16cm

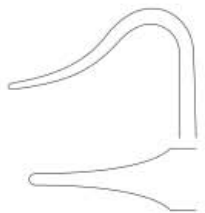

Blount Retractor
10-997
 17.5cm



Taylor Retractor
 16.5cm
10-998
 a=75mm - b=30mm
10-999
 a=100mm - b=30mm



Cushing Vein Retractor
10-1000 22.5cm
 with fenestrated handle
 Blade 12 mm width x 10 mm



Cushing Decompression Retractor
10-1001 21.5cm
 with fenestrated blade and handle
 Blade 13 mm width x 22 mm



Scoville Nerve Retractor
10-1002
 24cm
 7 mm straight



Scoville Nerve Retractor
10-1003
 24 cm, 7 mm angled



Taylor Retractor
 17cm
10-1004 30 x 75 mm
10-1005 30 x 100 mm



Hibbs Retractor
10-1006
 25 x 75 mm, 23cm
10-1007
 25 x 80 mm, 24cm



Meyerding Retractor
10-1008
 16 X 50 mm, 20cm
10-1009
 25 X 75 mm, 23cm
10-1010
 50 X 90 mm, 24cm



Nail Extracting Forceps
10-1011
 14cm



Nail Extracting Forceps
10-1012
 14.5cm

Orthopädie, Sehnenstripper

Orthopédie, enucleadores de tendones

Ortopedia, Instruments a ecorcher les tendons

Ortopedia, Scollatendini

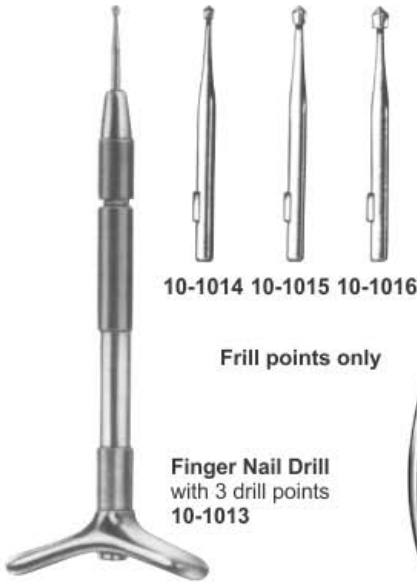

10-1014 10-1015 10-1016

Frill points only

Finger Nail Drill
with 3 drill points
10-1013



Nail Splitting
Forceps
10-1017
13.5cm



10-1019
Saw Blade Only
for 10-1018

Ring Cutter
10-1018
17cm



10-1021
Saw Blade Only
for 10-1020

Ring Cutter
10-1020
17cm



Tendon Tunelling Forceps
10-1022 13cm



10-1023
15cm

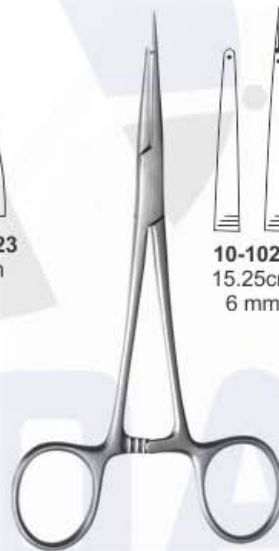

10-1024
15.25cm
6 mm



Lead Hand
10-1025 Adult Size



Brand Tendon
Forceps
10-1026 15 cm
10-1027 19 cm
10-1028 24 cm



Carroll Tendon Forceps
10-1029 13cm
Curved Shaft
2 mm x 6 mm



10-1030
14cm
Cross
serrated



10-1031
19cm
Serrated



Flat Nose
Plier
10-1032
18cm



Flat Nose Pliers
10-1033
13.5cm
Broad, 4mm tip,



Flat Nose Pliers
10-1034 16.5cm
Combination plier and
cutter



Needle Nose Pliers
10-1035 13.5cm



Flat Nose Pliers
10-1036
15cm Delicate,
1.5mm tip



**K-Wire Extraction Pliers
W/Screw Lock**
10-1037
13cm, 3mm tip



**Flat Nose
K-Wire Pliers**
10-1038
14cm
10-1039
17cm



Nose Pliers
10-1040
17cm



**Utility Technical
Forceps Pliers**
10-1041 19cm
adjustable



**Wire Bending
Forceps**
10-1042 18.5cm



Flat Nose Plier
10-1043 18.5cm
parallel grip, incorporated
cutter, for hard wires up to
1.6mm



Locking Plier
10-1044 18cm
10-1045 20cm
10-1046 24cm



Plate Bending Plier
10-1047 20cm
 for plates up to 2.7mm
10-1048 24cm
 for plates up to 4mm



Locking Plier
10-1049 22cm
10-1050 25cm
10-1051 30cm
 Locking plier, only
10-1052 30cm
 with holding pins
10-1053 46cm
 with extraction device



Needle-Nose Locking Pliers
10-1054



Needle-Nose Locking Pliers
10-1055



Needle-Nose Locking Pliers
10-1056



Flat Nosed Plier
10-1057 18cm
 parallell, with lateral
 wire cutter



Cast Spreader Model Usa
10-1058 23cm
 3 Prong



Nail Extractor
10-1059 16cm
 with Longitudinal Grove
 (for Intramudullary Gliding Nails)

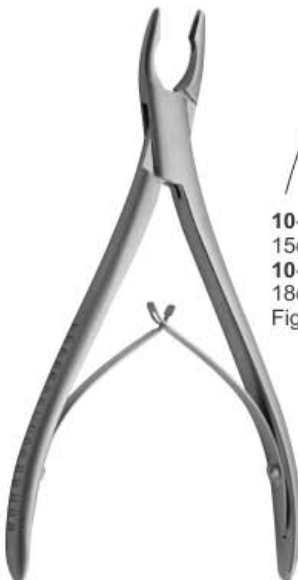

10-1060
 15cm
10-1061
 18cm
 Fig.1



10-1062
 15cm
10-1063
 18cm
 Fig.2

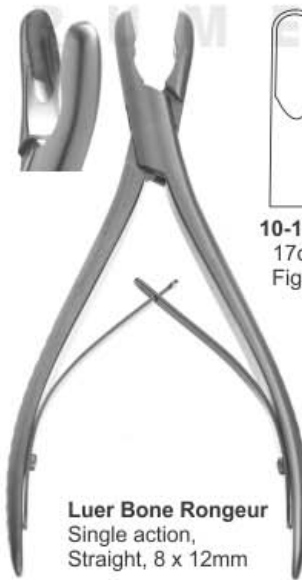

10-1064
 17cm
 Fig. 1



10-1065
 17cm
 Fig. 2



Friedmann Bone Rongeur
10-1066 14.5cm
 Single action, Curved,
 4 x 11mm

Hohlmeißelzangen
Pinzas gubias
Pincès-gouges
Pinze-sgorbie

10-1067
 15.5cm
 Fig. 1

10-1068
 15.5cm
 Fig. 2

10-1069
 15.5cm
 Fig. 3

10-1070
 18cm
 Fig. 1

10-1071
 18cm
 Fig. 2

Jansen Bone Rongeur
10-1072 19cm

10-1073
 17.5cm
 slightly curved

10-1074
 17.5cm
 Strongly curved

10-1075
 15.5cm
10-1076
 19cm
 Straight

10-1077
 15.5cm
10-1078
 19cm
 Curved

Rongeur #4
10-1079 14cm
Rongeur #4A
10-1080 16.5cm
 Single action,
 Curved, 4 x 9mm

Chichirelli (Blumenthal) Rongeur
10-1081 15cm
 Single action, Curved 45°,
 4 x 13mm

Dean (Blumenthal) Rongeur
10-1082 15cm
 Single action,
 Curved 90°, 4 x 11mm

Dean Rongeur
10-1083 14.5cm
 Single action
 Curved, 3mm

Hohlmeißelzangen
Pinzas gubias

Pinces-gouges
Pinze-sgorbie



Hartmann Bone Rongeur
10-1084 18.5cm
Single action
Curved, 4 x 14mm

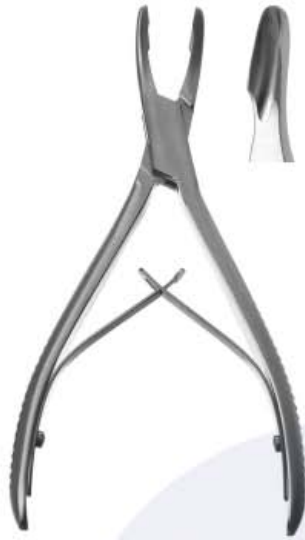

Mead Bone Rongeur
10-1085 16.5cm
Single action,
Curved, 5 x 13mm



Cleveland Bone Rongeur
10-1086 14cm
10-1087 17cm

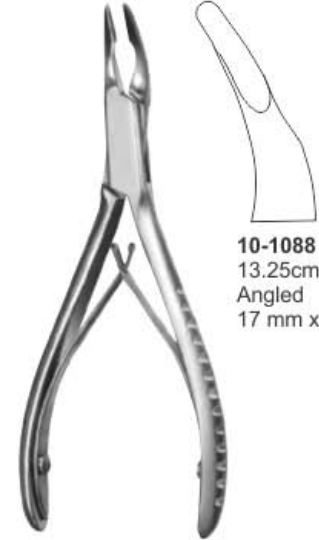

Universal Bone Rongeur

10-1088
13.25cm
Angled
17 mm x 3.5 mm



Bane Bone Rongeur



10-1089
18cm
Single action
Curved,
3 x 16mm



Bohler Bone Rongeur

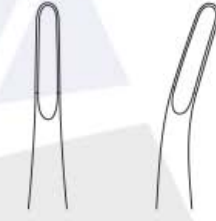

10-1090 15c
Straight

10-1091 15cm
Curved



Zaufal-Jansen Bone Rongeur
10-1092 18cm
Double action
Curved, 5x15mm



Marquardt Bone Rongeur
10-1093 18cm



Beyer Bone Rongeur
18cm
10-1094 3 x 14mm
10-1095 4 x 15mm
Double action, Curved



Smith-Peterson Laminectomy Rongeur
10-1096 24cm
Double action,
Straight 3 x 16mm



Smith-Peterson Laminectomy Rongeur
10-1097 24cm
Double action
Curved 3 x 16mm

Hohlmeißelzangen
Pinzas gubias

Pinces-gouges
Pinze-sgorbie



Ruskin Rongeur
10-1098 18cm 4x16mm
10-1099 18.5cm 5x10mm
Double action, Curved on side



Ruskin Rongeur
10-1100 18.5cm
Double action, 6 x 16mm,
Straight, Curved



Ruskin Rongeur
10-1101 15.5cm Straight, 3.2mm
10-1102 15cm Curved, 2 x 15mm
10-1103 15cm Curved, 3 x 15mm
Double action,



Riskin Bone Rongeur



10-1104 15.5cm
10-1105 18cm
Double action
Straight, 2 x 14mm

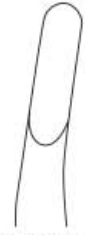

10-1106 15.5cm
10-1107 18cm
Double action
Curved 2 x 14mm



Mayfield Bone Rongeur
10-1108 18cm



Stille-Ruskin Bone Rongeur



10-1109
23cm
Curved



10-1110
23cm
Straight



Leksell Bone Rongeur
10-1111 24.5cm 5 x 13mm
10-1112 24cm 8 x 14.5mm
Double action, Curved 50°



Leksell Rongeur
10-1113 24cm
6 x 15mm
10-1114 24cm
7 x 13mm
Double action, Curved



Leksell Rongeur
10-1115 24cm
3 x 18mm
Double action, Curved



Leksell Rongeur
10-1116 23cm
4 x 13mm
Double action
Fully curved



Stille Bone Rongeur



10-1117
23cm
4mm



10-1118
23cm
6mm



10-1119
23cm
8mm



Stille-Luer Rongeur Forceps



10-1120
23cm
10-1121
27cm
straight



10-1122
23cm
10-1123
27cm
curved



Echlin Duckbill Bone Rongeur 23cm



10-1124
2 x 12mm
Double action
Curved on side



10-1125
3 x 12mm
Double action
Curved on side



10-1126
4.5 x 11mm
Double action
Curved on side



Stille-Leur Rongeur
10-1127 21.5cm
Curved, Straight
Double action, 10 x 18mm



Stille-Leur Rongeur
10-1128 26.5cm
Straight, Curved
Double action, 10 x 18mm



**Stille-Luer Echlin
Duckbill Rongeur**
23cm
10-1129 6 x 13mm
10-1130 6 x 15mm
Double action Curved on side



Stille-Leur Rongeur
10-1131 21.5cm
Double action
Curved 10 x 16mm



**Rottgen-Ruskin
Bone Rongeur**
10-1132 23cm



Semb Bone Rongeur
10-1133 24cm



Frykholm Bone Rongeur
10-1134 24cm



Sauerbruch Bone Rongeur
30cm



10-1135
Round
Fig. 1

10-1136
Straight
Fig. 2



Luer-Stille Bone Rongeur
27cm

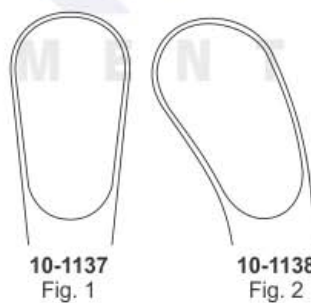

10-1137
Fig. 1

10-1138
Fig. 2



Leksell-Stille Bone Rongeur



10-1139
24cm

10-1140
24cm

Hohlmeißelzangen
Pinzas gubias

Pinces-gouges
Pinze-sgorbie



Leksell Bonerongeur



- 10-1141 25cm 3 x 16mm
- 10-1142 23cm 5 x 16mm
- 10-1143 25cm 4.5 x 16mm
- 10-1144 25cm 6 x 16mm
- 10-1145 25cm 7 x 16mm
- 10-1146 25cm 8 x 16mm
- Double action, Curved 15°



Hakansson Bone Rongeur
10-1147 20cm



Kleinert-Kutz Bone Rongeur

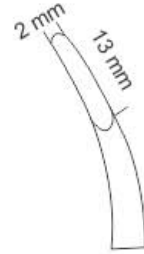

10-1148
15.25cm
2 x 13 mm



Ruskin-Mini Bone Rongeur



10-1149
15.25cm
Curved
18 x 5 mm



Sybert Rongeur

- 10-1150 35.5cm 4 x 16mm
- 10-1151 35.5cm 8 x 16mm
- 10-1152 35.5cm 12 x 16mm
- 10-1153 37cm 5 x 16mm
- Double action, Angled



Cottle-Kazanjian Bone
Cutting Rongeur Forceps
10-1154 19cm



Littauer / Liston Bone
Cutting Rongeur Forceps



10-1155
15cm
Straight,

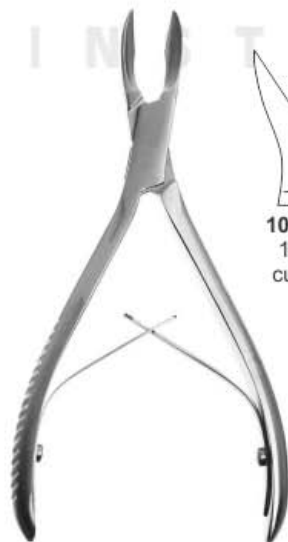

Cleveland Bone Cutting
Rongeur Forceps



10-1156
15cm
curved



10-1157
17cm
curved



Liston Bone Cutting
Rongeur Forceps



10-1158
14cm
Angled



10-1159
17cm
Angled



10-1160
19cm
Angled



10-1161
22cm
Angled

Knochensplitterzangen
Pinces coupantes a os

Pinzas cortantes para huesos
Cesoie per ossa



10-1162 14 cm
10-1163 17 cm
10-1164 19 cm
10-1165 20 cm
10-1166 22 cm
Straight

Liston Bone Cutting Rongeur Forceps



10-1167
27 cm
Straight

10-1168
27cm
Angled 45°

10-1169
27 cm
Angled 90°

Stille-Liston Bone Cutting Rongeur Forceps



Semb Bone Cutting Rongeur Forceps
10-1170 24cm



Liston Key Horsley Bone Cutting Rongeur Forceps
10-1171 27cm



Horsley Bone Cutting Rongeur Forceps
10-1172 25cm



Ruskin Bone Cutting Rongeur Forceps
10-1173 20cm
Double-Action



10-1174
16cm

Cleveland-Gardner Bone Cutting Rongeur Forceps

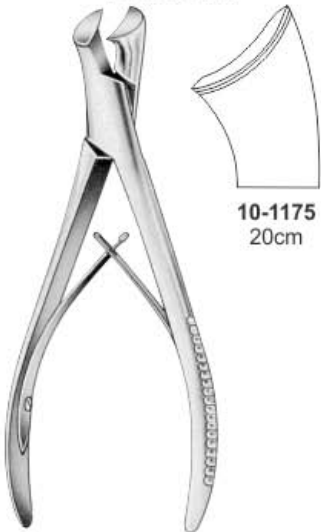

10-1175
20cm

Markwalder Bone Cutting Rongeur Forceps



Bone Cutting Rongeur Forceps
10-1176 15cm



10-1177
15cm
Straight

10-1178
15cm
Angled

Bohler Bone Cutting Rongeur Forceps

Knochensplitterzangen
Pinces coupantes a os

Pinzas cortantes para huesos
Cesoie per ossa

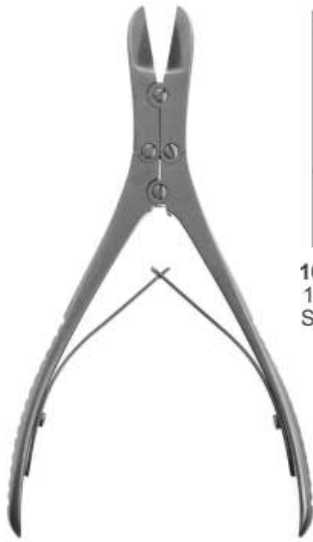

10-1179
18.5cm
Straight

Ruskin-Liston Bone Cutting Rongeur Forceps



10-1180
18.5cm
Angled

Walton-Liston Bone Cutting Rongeur Forceps



10-1181
15cm
Straight



10-1182
15cm
Angled



Ruskin-Liston Bone Cutting Rongeur Forceps



10-1183 Straight
10-1184 Curved
10-1185 Angled
19cm deicate



10-1186
17.5cm
Straight

Mc Indoe Bone Cutting Rongeur Forceps



10-1187
17.5cm
Curved



Mc Indoe Bone Cutting Forceps
10-1188 18cm
Angled, delicate,



Kleinert-Kutz Bone Cutting Forceps
10-1189 15cm
Straight, delicate,



Kleinert-Kutz Synovectomy Rongeur
10-1190 15cm 2 x 10mm
Double action,
Curved on side, delicate,



10-1191
27cm
Straight

Stille-Liston Bone Cutting Rongeur Forceps



Stille-Horsley Bone Cutting Forceps
10-1192 24cm



Liston Bone Cutting Rongeur Forceps

10-1193
23cm
Angled

10-1194
27cm
Angled

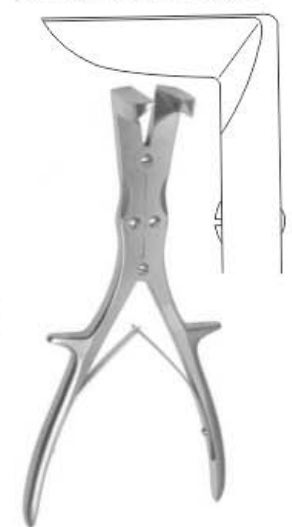

Liston-Stille Bone Cutting Rongeur Forceps
10-1195 26cm

Drahtschneidezangen
Pinces coupantes

Alicates para cortar alambre
Pinze taglia Filo

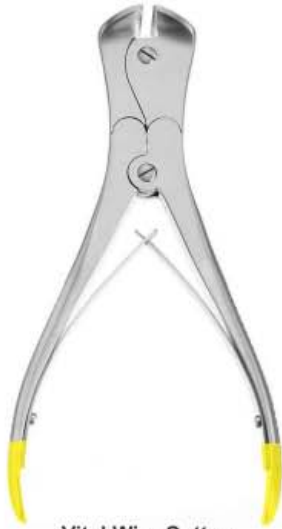

Vital Wire Cutter
10-1196 22cm
for hard wires up to 2.2mm,
for soft wires up to 3mm



Vital Wire Cutter
10-1197 22cm
for hard wires up to 2.2mm,
for soft wires up to 2.8mm



Vital Wire Cutter
10-1198 23cm
for hard wires up to 2.2mm,
for soft wires up to 3mm



Vital Wire Cutter
10-1199 18cm
for hard wires up to 1.5mm,
for soft wires up to 2mm



**Pin Puller W/
Groove TC**
10-1200 14cm



Vital Wire Cutter
10-1201 18cm
for hard wires up to 1.7mm,
for soft wires up to 2mm



Vital Wire Cutter
10-1202 15cm
for hard wires up to 1mm,
for soft wires up to 1.5mm



Vital Wire Cutter
10-1203 14.5cm
for hard wires up to 1mm,
for soft wires up to 1mm



**Cannulated Wire
/ Pin Cutter**
10-1204 19cm
Cuts wire upto 1.6 mm



Hard Wire Cutter Cuts
10-1205 26cm
for hard wires up to 3mm



**Kirschner Wires &
Steinmann
Pins Cutter**
10-1206 57cm
up to 6mm



Side Pin Cutter
10-1207
57.5cm
Side cutting w/
carbide inserts
max. cap: 5/32"



**Vital Heavy
Duty Pliers TC**
10-1208
22cm
Grip Forceps,
Combined
with cutter



**Vital Wire
Extraction
Pliers T.C**
10-1209 5mm
10-1210 7mm
18cm



Side Cutter
10-1211 18.5cm
 Welded carbide jaws
 max capacity. 1.6mm



Delicate Wire Cutter
10-1212 12.5cm
 Side cutting w/ carbide inserts
 max capacity. 0.7mm



Front & Side Wire Cutter
10-1213 17cm
 Front and side cutting w/ carbide inserts,
 double action. Max capacity. 1.6mm



Double Action Wire Cutter
 Angled, Side cutting w/
 carbide inserts
10-1214 17cm
 max cap 1.6mm
10-1215 21.5cm
 max cap. 2.4mm



Flush Wire Cutter
10-1216 17cm
 Front and side cutting w/ carbide inserts,
 double action. Max capacity. 1.5mm



Wire Forceps
10-1217 17cm
 Straight, serrated 5.4 mm tip



Pin Cutter Small
10-1218 26cm
 Max cap: 3.2mm



Pin Cutter Medium
10-1219 36.5cm
 Max cap: 4.7mm



Large Pin Cutter
10-1220 57.5cm
 Large, Straight, Max.
 capacity 6.3mm



Stille Plaster Shear
10-1221 37cm



**Schumacher Sternum
 Shears**
10-1222 21cm



Gerster-Lowmann Bone Clamp
 10-1223 12cm
 10-1224 14.5cm
 10-1225 18cm, 28mm
 10-1226 20cm, 35mm
 10-1227 22cm, 40mm
 1x2 Jaws



Lowmann Bone Clamp
 10-1228 12cm
 10-1229 15cm
 10-1230 17cm
 10-1231 18.5cm
 10-1232 20cm



Lambert-Lowman Bone Clamp
 10-1233 17.5cm
 10-1234 20.3cm
 2x2 Jaws

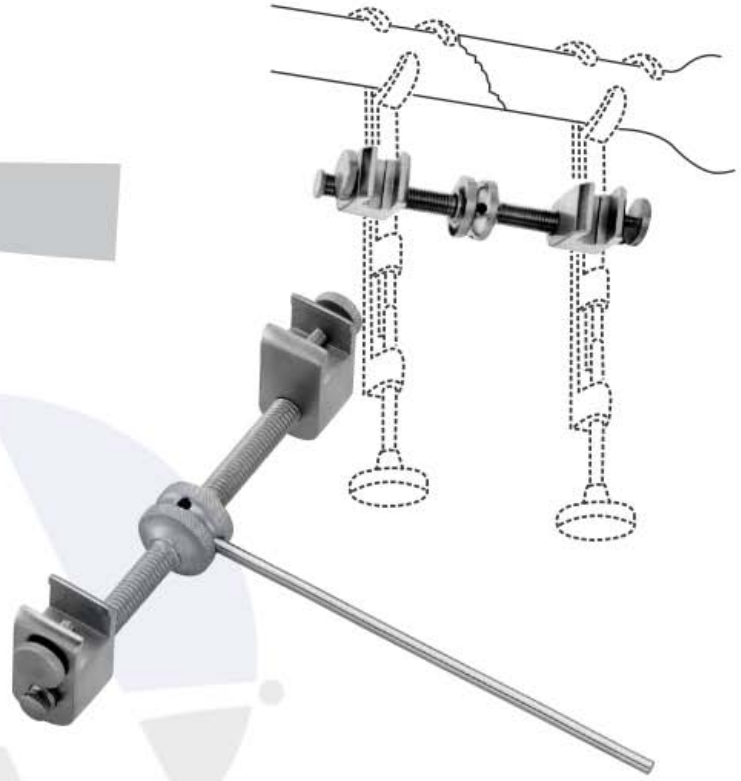

Gerster Bone Holding Clamp
 10-1235 15cm



Gerster Bone Holding Clamp
 10-1236

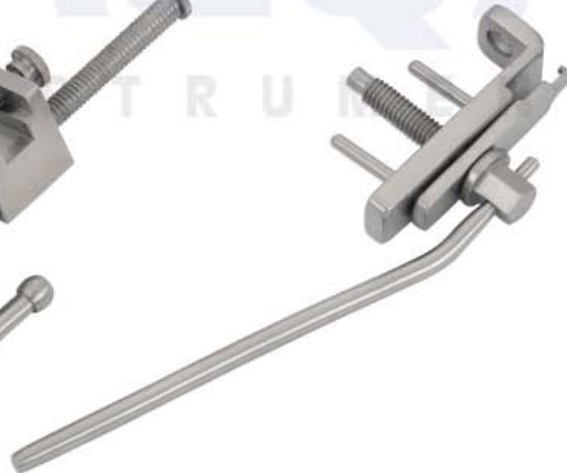

Gerster Bone Holding Clamp
 10-1237



Parham-Martin Bone Clamp
 10-1238 21cm
 Straight



Parham Martin Bands
 10-1239 19cm



Bone Reduction Forceps
10-1240 13.5cm



Locke Phalangeal Forceps
10-1241 14cm



Lewin Perforating Bone Holding Forceps

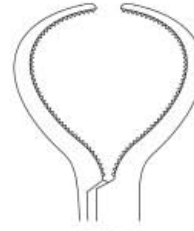

10-1242
17.5cm
serrated



Stagbeetle Bone Reduction Forceps
10-1243 Pointed tips, 13cm



10-1244
13.5cm
Angled
Serrated



Shoulder Percussion Awl
Pointed, 21.6cm
10-1245 Small
10-1246 Medium
10-1247 Large
10-1248 Pointed,
23.5cm



Meniscus Clamp
10-1249 13.5cm
Serrated



Meniscus Clamp
10-1250 13.5cm
Angled 20°, serrated



Preston Logamentum Flavum Forceps
10-1251 19cm
Curved, 1 x 2 teeth



Meniscus Clamp
10-1252 18cm
Straight, Curved shaft



Dingman Bone Clamp
10-1253 19cm
Straight, Serrated,
1 1/2" tip length, Curved shaft

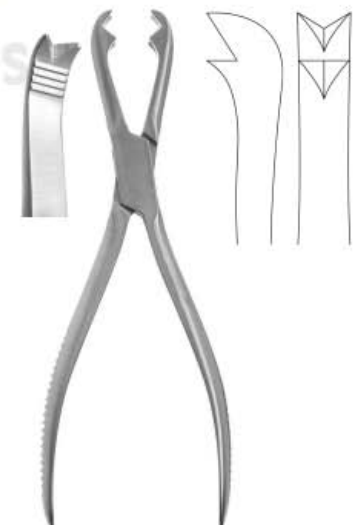

Fergusson Bone Holding Forceps
10-1254 21cm 2 x 2 teeth

Knochenhaltezaugen
Daviers porte-so

Pinzas para huesos
Tenaglie per ossa



Van Buren Sequestrum Forceps
10-1255 23cm
Curved on side, serrated



Langenbeck Bone Holding Forceps
10-1256 21cm

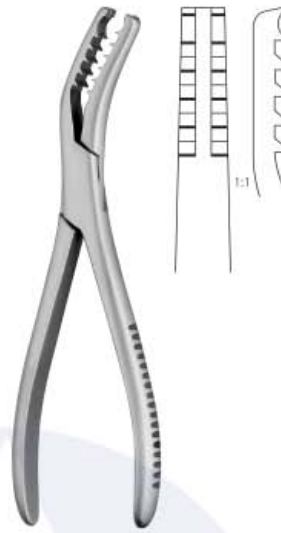

Semb Bone Holding Forceps
10-1257 19cm without ratchet
curved sideways deep teeth



Semb Bone Holding Forceps
10-1258 20.3cm, with ratchet
curved sideways deep teeth



Sequestrum (Nircosis) Bone Holding Forceps



Farabeuf Bone Holding Forceps with adjustable jaw



Farabeuf-Lambotte Bone Holding Forceps with adjustable jaw

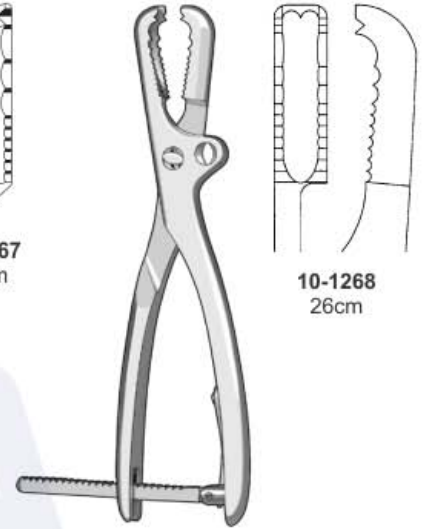

Farabeuf-Lambotte Bone Holding Forceps with adjustable jaw



Bishop Bone Clamp
10-1269 22.5cm
Straight



Kern Bone Holding Forceps
10-1270 17cm
10-1271 24cm
without ratchet



Kern Bone Holding Forceps
10-1272 17cm
10-1273 24cm
with ratchet



Hey Groves Bone Holding Forceps

Knochenhaltezaugen
Daviers porte-so

Pinzas para huesos
Tenaglie per ossa



- 10-1277
33cm 11 mm tip W/ Ratchet
- 10-1278
33cm 13 mm tip W/ Ratchet
- 10-1279
43cm 13.5 mm tip W/ Ratchet
- 10-1280
13cm 10 mm tip W/o Ratchet

Lane Bone Holding Forceps
Light Model



Lane Bone Holding Forceps
10-1281 33cm 13 mm tip
10-1282 43cm 12 mm tip
without ratchet



Ulrich Bone Holding Self Retaining Forceps



- 10-1283 18 cm mini
- 10-1284 22 cm
- 10-1285 26 cm
- 10-1286 28 cm
- Straight with speed lock

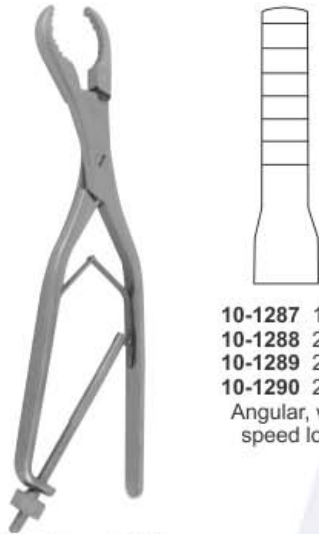

- 10-1287 18cm
- 10-1288 22cm
- 10-1289 26cm
- 10-1290 28cm
- Angular, with speed lock

Ulrich Bone Holding Forceps



- 10-1291
28cm

Ulrich Bone Holding Forceps
Angular With Speed Lock
& swivel jaw



- 10-1292
22cm
- 10-1293
27cm
- 10-1294
30cm

Lambotte Bone Holding Forceps
One Jaw Mobile
adjustable jaw



Lane Bone Holding Forceps
10-1295 31.5cm
10-1296 39cm



- 10-1297
15 cm, 2.5mm
- 10-1298
19 cm, 6.5mm
- 10-1299
24 cm, 9.5mm
- 10-1300
26 cm, 10mm
- 10-1301
28 cm, 11mm

Lambotte Bone Holding Forceps
Self-Centering, with speed lock



Subacromion Spreader
10-1302 26.75cm Right
10-1303 26.75cm Left



Bone Reduction Forceps
10-1304 14cm
Serrated with pointed tips



Bone Reduction Forceps
 10-1305 14cm Curved
 10-1306 15cm Serrated



10-1307
 14cm Serrated
 10-1308
 14cm Curved
 10-1309
 17cm Curved

**Bone Reduction Forceps,
 Pointed Tips**



Semb Bone Holding Forceps
 Curved on side
 10-1310 19cm 4 x 5 teeth
 10-1311 21cm 5 x 5 teeth



**Martin Cartilage Bone Holding
 Clamp Forceps**
 10-1312 19 cm Str.



10-1313
 20cm
 Str.

**Bircher-Ganske
 Bone Holding Forceps**



10-1314
 20cm
 Cvd.



10-1315
 17.5cm
 5.0mm

**Verbrugge Bone
 Holding Forceps**



10-1316
 25cm
 9.5mm

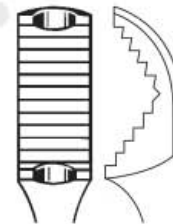

10-1317
 26cm
 10.5mm

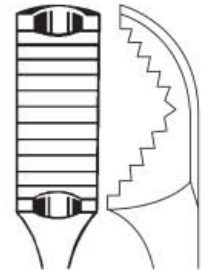

10-1318
 27cm
 12.0mm

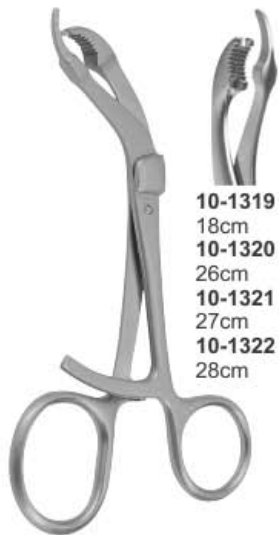

10-1319
 18cm
 10-1320
 26cm
 10-1321
 27cm
 10-1322
 28cm

**Verbrugge Bone
 Holding Forceps
 W/ Long Ratchet**

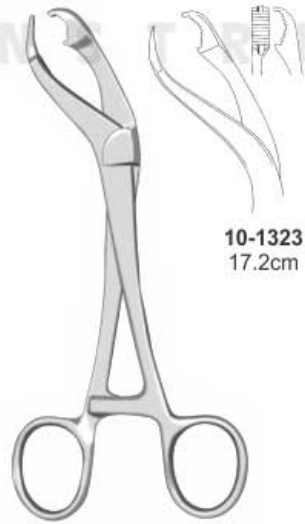

10-1323
 17.2cm

**Verbrugge Bone Holding
 Forceps
 with short ratchet**



10-1324 15 cm
 10-1325 19 cm
 10-1326 24 cm
 10-1327 26 cm
 10-1328 29 cm

**Verbrugge Self-Centering
 Bone Holding Forceps
 with long ratchet**



**Lane Bone Plate Holding
 Forceps**
 10-1329 22cm

Knochenhalte
Daviers porte-so

Pinzas para huesos
Tenaglie per ossa



Verbrugge Bone Holding Forceps
10-1330 18cm



Verbrugge Bone Holding Forceps
10-1331 18cm



10-1332
25cm
10-1333
26cm
10-1334
27cm

Verbrugge Bone Holding Forceps



10-1335
25cm
10-1336
26cm
10-1337
27cm

Verbrugge Bone Holding Forceps



Verbrugge Bone Holding Forceps
10-1338 18cm



10-1339
25cm
10-1340
26cm
10-1341
27cm

Verbrugge Bone Holding Forceps



Bone Reduction Forceps
10-1342 13.5cm



Reill Bone Reduction Forceps
10-1343 17cm
Curved, pointed tips

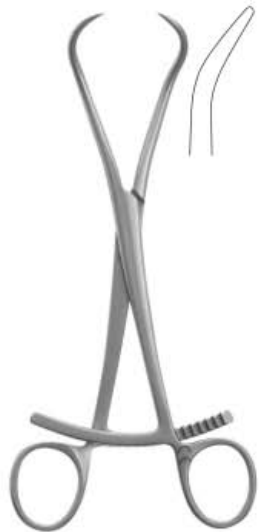

Bone Reduction Forceps
10-1344 20.4cm
Pointed tips



Bone Reduction Forceps
10-1345 13.5cm
for maxillary reposition



Haase
10-1346 16.5cm
for mandibular fractures



10-1347
9.5cm

10-1348
9.5cm

Bone Holding forceps

Knochenhaltezaugen
Daviers porte-os
Pinzas para huesos
Tenaglie per ossa

Fibula Bone Holding Forceps
10-1349 22cm

Glennoid Perforating Forceps
10-1350 17cm
 Lightly curved, pointed tips
 Strongly curved, pointed tips

Reil Bone Holding Forceps
10-1351 17cm

Bone Reduction Forceps
10-1352 20cm
 with Points

Pelvic Reduction Forceps Asymmetric
10-1353 40cm

Malleolar Bone Holding Forceps
10-1354 21cm
 Straight, 1 x 1 teeth

Patella Malleolar Forceps
10-1355 21cm

10-1356
 16cm
10-1357
 24cm

Reposition Forceps
10-1358 23cm

Pelvic Reposition Forceps
10-1359 19cm
10-1360 23cm

Pelvic Reposition Forceps
10-1361 25cm

Pelvic Reposition Forceps
10-1362 25cm
 3 Balls Spikes

Pelvic Reduction Forceps Asymmetric
 with 3 ball Spikes
10-1363
 25cm

Pelvic Reduction Forceps Asymmetric
10-1364 25cm

Pelvic Reposition Forceps
10-1365 40cm

Pelvic Reposition Forceps
10-1366 40cm



Bunnell Drill
10-1367 16cm
Opening up to 4mm
10-1368 spare key
light metal housing
longitudinally cannulated



Ralk Drill
10-1369 16cm
Opening up to 6.35mm
light metal housing
longitudinally cannulated



10-1372



Plaster Saw Electronic Power
Volt #110
10-1370
Volt #220
10-1371



10-1373
Spare Blade



Moore Drill And Bit Set Complete
10-1374

I N S T R U M E N T S



Fig. 1 10-1376 2.5mm
Fig. 2 10-1377 3.0mm
Fig. 3 10-1378 3.5mm
Fig. 4 10-1379 4.0mm
Fig. 5 10-1380 5.0mm
Fig. 6 10-1381 8.0mm
Fig. 7 10-1382 12.0mm
Fig. 8 10-1383 16.0mm
Fig. 09 10-1384
Fig. 10 10-1385 1.0mm
Fig. 11 10-1386 1.5mm
Fig. 12 10-1387 2.0mm

Stille Pattern Drill Set
10-1375
Complete set of stainless
drill bits and burrs



10-1388
Hudson Brace 26.7cm
with standard thumb screw chuck

10-1389
Hudson Brace 27.9cm
with Improved Snap-Lock chuck

- C 10-1390 Hudson Bur, 9mm Diameter
- D 10-1391 Hudson Bur, 14mm Diameter
- E 10-1392 Hudson Bur, 16mm Diameter
- F 10-1393 Hudson Bur, 22mm Diameter
- G 10-1394 Cushing Perforator, for Hudson Brace
- H 10-1395 Hudson Cerabellar Extension, 4" for Hudson Brace
- I 10-1396 McKenzie Perforator for Hudson Brace



Jacobs
10-1397 28cm
opening up to 6.35mm



Hand Drill
10-1398
opening up to 6.35mm



T-Handle
10-1399
AO Coupling



Jacob's Chuck
10-1400 T-Handle and key
10-1401 only
10-1402 Key

I N S T R U M E N T S



Key Handle
10-1403



T-Handle
10-1404
for AO Coupling



Memoral Head Extractor
10-1405



HEXAGONAL HEAD

	Size of screws	Head Size	Fiber-Handle	AO Coupling	Dental Coupling
A	1.5mm	1.5mm	10-1406	10-1409	10-1412
B	2.0mm				
C	2.7mm	2.5mm	10-1407	10-1410	
D	3.5mm				
E	4.0mm				
F	4.5mm	3.5mm	10-1408	10-1411	
G	6.5mm				



Parallel Target Device
10-1413
for guide wires 2mm



Mortising Chisel
10-1414



Wire Guide
10-1415
45mm



Wire Guide
10-1416
70mm



Countersink
10-1417



Countersink
10-1418



Countersink
10-1419



Perthes
10-1420 18cm
10-1421 21cm



10-1422
14cm



10-1423
14cm



Mini Drill Sleeve
10-1424
1.1 mm and 1.5 mm drill bits
10-1425
1.5 mm and 2.0 mm drill bits



Drill Guide
10-1426
drill sleeve for 2.0 mm drill bit



10-1427 Tap Sleeve, 2.0 mm \emptyset
10-1428 Drill Sleeve, 2.7 mm \emptyset
10-1429 Tap Sleeve, 2.5 mm \emptyset
10-1430 Drill Sleeve, 3.5 mm \emptyset



Neutral & Load Drill Guide
10-1431 1.5 mm for 2.0 mm Screws
10-1432 2.0 mm for 2.7 mm Screws
10-1433 2.5 mm for 3.5 mm Screws
10-1434 3.2 mm for 4.5 mm Screws



Tap Sleeve
10-1435
 3.5 mm



Tap Sleeve
10-1436
 3.5 mm also for used
 as 3.2 mm drill Guide



Tap Sleeve
10-1437
 4.5 mm



Drill Sleeve
10-1438 3.2 mm
 for Round Hole Plates



Drill Guide
10-1439 4.5 mm Screws
 Drill Bit 4.5 mm & 3.2 mm



Drill Guide
10-1440 6.5 mm Screws
 Drill Bit 3.2 mm



Drill Guide
10-1441 3.5 mm for neutral and
 compression Positioning Drill Bit 2.5 mm



C - Clamp
10-1442
 Drill Guide with thread
 for Drill Bit 4.5 mm



Insert Drill Sleeve
10-1443 2.7 / 2.0 mm Drill Bit 2.0 mm
10-1444 3.5 / 2.5 mm Drill Bit 2.5 mm
10-1445 4.5 / 3.2 mm Drill Bit 3.2 mm



Drill Small Pointed
10-1446 Drill Bit 3.5 mm



Drill Pointed Guide
10-1447 6.5 mm



Drill Pointed Guide
10-1448 6.5 mm



**Bending Device
10-1449**
21.5cm
to bend straight
and angled plates



**Bending Device
10-1450**
21.5cm
to bend straight
and angled plates



**Rod Bender
10-1451**
to bend straight
and angled



**Universal Rod Bender
10-1452** 28.5cm
to bend straight
and angled



**Rod Bender
10-1453**
to bend straight
and angled



**Slotted Hammer
10-1454** 14mm



**Plate Bender
10-1455**



**Plate Bender
10-1456**



**Plate Bender
10-1457**



**Plate Bender
10-1458**



**Plate Bender
10-1459**



**Plate Bender
10-1460**



**Plate Bender
10-1461**



10-1462 18cm
Wire strainer for
kirschner wires



Kirschner Extension Bows

- 10-1463** x=95mm y=70mm
- 10-1464** x=100mm y=100mm
- 10-1465** x=120mm y=120mm
- 10-1466** x=155mm y=155mm
- 10-1467** x=200mm y=155mm
with 3 traction hooks



Kirschner Extension Bows

- 10-1468** x=130mm
- 10-1469** x=185mm
- 10-1470** x=220mm
with 3 traction hooks



**Wrench
Kirschner
Extension Bows
10-1471**
14mm/17mm



Kirschner Extension Bows

- 10-1472** x=180mm y=100mm
- 10-1473** x=270mm y=160mm
with 3 traction hooks



Bohler Kirschner Extension Bows

- 10-1474** x=75mm y=90mm
- 10-1475** x=90mm y=160mm
- 10-1476** x=110mm y=210mm
- 10-1477** x=150mm y=210mm
with 3 traction hooks



**Charnley-mueller
10-1478**
Compression Clamp



Screw Depth Gauges

- 10-1479 Mini Gauge, Longmeasures up to 30mm
- 10-1480 Small Gauge, Longmeasures up to 50mm
- 10-1481 Large Gauge, Longmeasures up to 100mm
- 10-1482 X-Large Gauge, Longmeasures up to 120mm



Screw Depth Gauges

- 10-1483 Mini Gauge, Longmeasures up to 30mm
- 10-1484 Small Gauge, Longmeasures up to 50mm
- 10-1485 Large Gauge, Longmeasures up to 100mm
- 10-1486 X-Large Gauge, Longmeasures up to 120mm

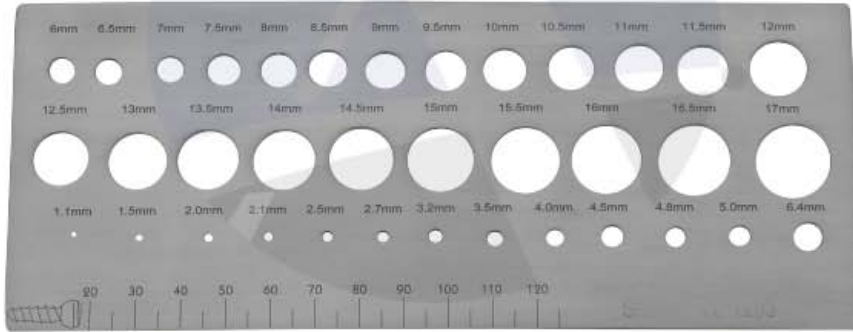

**Measuring Gauge
10-1487
for nail**

10-1488 Tri Angular Positioning Plate

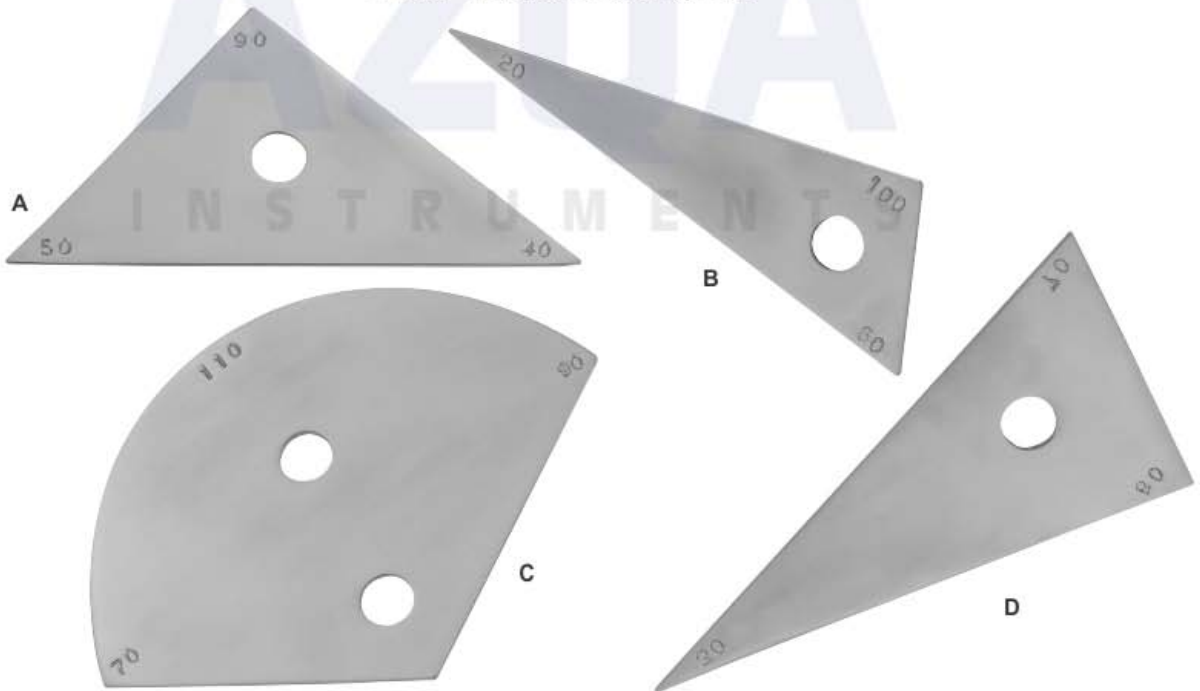

NEUROSURGERY INSTRUMENTS





GALT
11-001 Ø 12,5 mm
11-002 Ø 16 mm
11-003 Ø 19 mm

Hubson, Brace Hand Drill 11-004 27cm
complete with 4 twist drills
(Fig. 1 - Fig. 4) and extension piece

Hudson Brace 11-005
28cm with Improved
Snap-Lock chuck



Huson Hand
drill bit
Fig.1
11-006
9mm

Huson Hand
drill bit
Fig.2
11-007
14mm

Huson Hand
drill bit
Fig.3
11-008
16mm

Huson Hand
drill bit
Fig.4
11-009
22mm

Cushing
Hand drill bit
11-010
14mm

Hudson
Cerabellar
Extension
10cm
11-011
Hudson Brace

McKenzie
Hand drill bit
11-012
13mm

Schadelhalter

Pinzas de traccion cranial

Pinces de traction Cranienne

Pinze per trazione craniale



**Crutchfield
Traction Tongs
11-013 13cm
small**

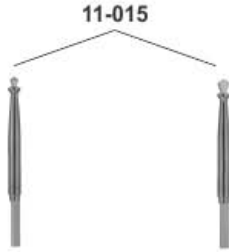

Crutchfield drill bit 3.5mm **Crutchfield drill bit 5mm**

Set of 2 Pieces for
11-013 and 11-014



**Crutchfield
Traction Tongs
11-014 18.5cm**



11-015
Wrench double-ended for



**Crutchfield Skull
11-016**

large type, cervical traction tongs -
pins adjustable no drilling to be done
11cm



**Cloward Vertebral Cervical
Spreader
11-017**



**Spinal Distractor
11-018 24cm
45° angle / small style
6mm rods**



**Spinal Distractor
11-019 25.5cm
small style**



**Inge Retractor
11-020 20.5cm
toothed w/spindle**



Supra Cut Distraction Screw
 11-021 12mm Non Sterile
 11-022 14mm Non Sterile
 11-023 16mm Non Sterile
 11-024 18mm Non Sterile
 11-025 12mm Sterile
 11-026 14mm Sterile
 11-027 16mm Sterile
 11-028 18mm Sterile



Supra Cut Distraction Screw Driver
11-029



Cloward Retractor
11-030 15.5 cm

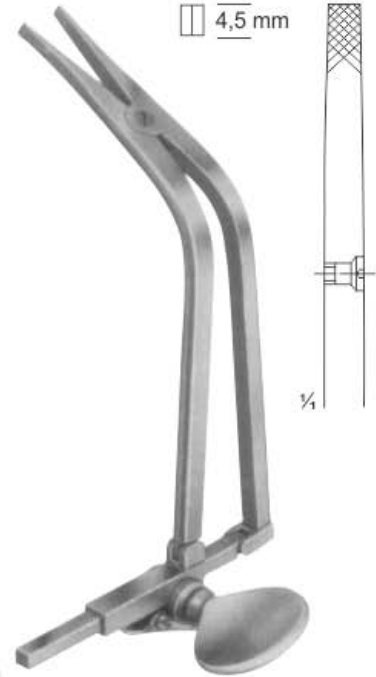

Cloward Retractor
11-031 13.5 cm



Inge Lamina Spreader
11-032
16 cm



Inge Retractor
11-033 17 cm

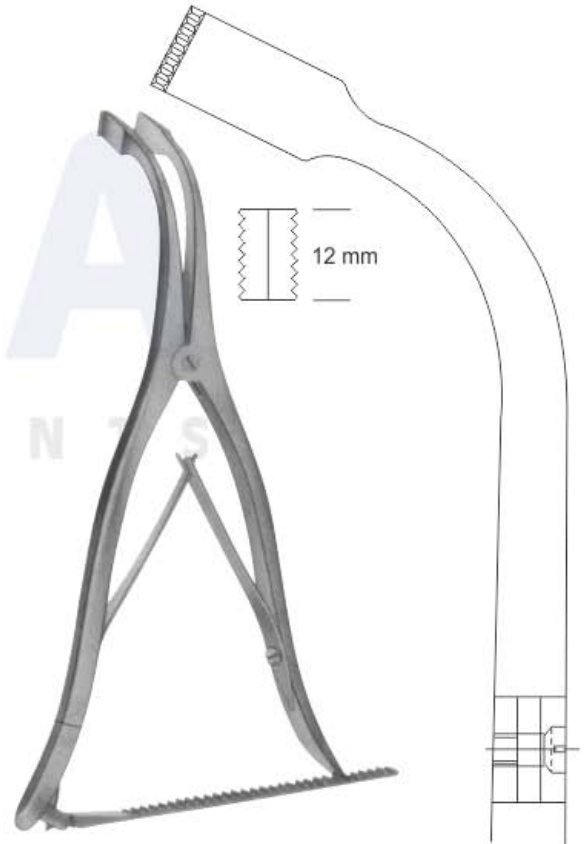

Inge Retractor
11-034 27.5 cm



De Martel
Saw Conductor
11-035 33cm



Adson
Drill guide
11-036
15cm



De Vibiss
Skull Forceps
11-037
20cm



Dahlgren
11-038
Cranial Rongeur
20 cm



Gigle-Strully
Handle for
wire saw
11-039

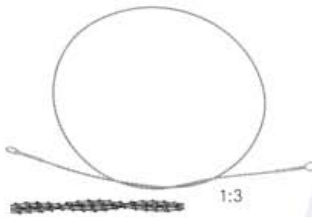

Olivecrona
Wire Saw
11-040 30cm
11-041 40cm
11-042 50cm
11-043 60cm
11-044 70cm

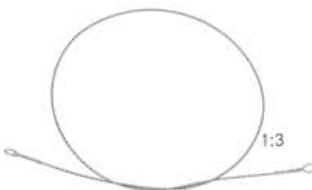

Gigle, Wire Saw
11-045 30cm
11-046 40cm
11-047 50cm
6 wires twisted



Bailey-Gigli
11-048
Saw Guide 30.5cm
flexible



Davis
11-049
Guide for Gigli Saws,
20cm



Michele Trepine,
11-050 16cm shaft, 0.47cm
O.D graduated 0.64cm To 3.2cm
11-051 16cm shaft, 0.79cm
O.D graduated 0.64cm To 3.2cm
11-052 16cm shaft, 0.56cm
O.D graduated 0.64cm To 3.2cm

11-050

11-051

11-052

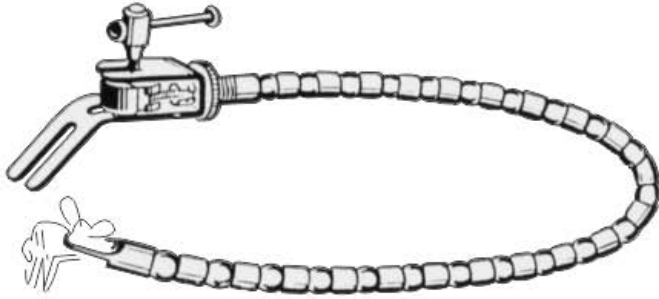

11-053
wire cable only

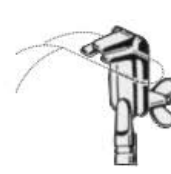

11-054
Support only,
flat brain spatulas,

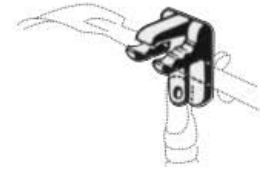

11-055
Support only,
for brain spatulas
with round shaft
up to 5.5 mm diam.
Fixing for flexible



Riechert
11-056
Fixation base, for skull
mounting, holding 1
flexible arms



Riechert
11-057
Fixation base, for skull
mounting, holding 2
flexible arms



11-058
Fixation base, for skull
mounting, holding 1
flexible arms

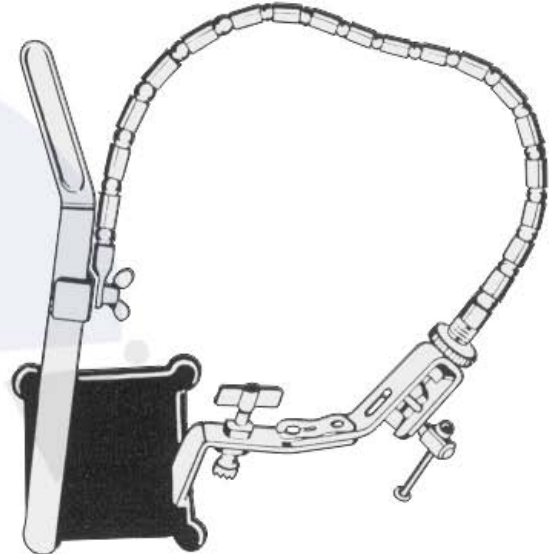

Leyla
Self-Retaining Brain
Retractor
with 1 flexible arm, complete consisting of
11-059
11-060
11-061

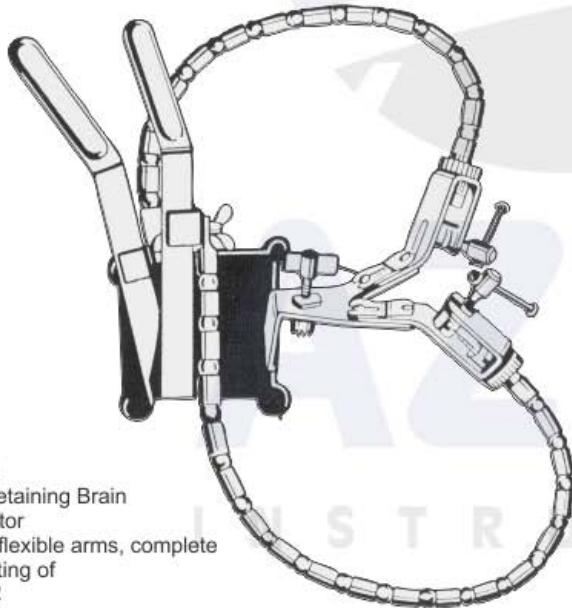

Leyla
Self-Retaining Brain
Retractor
with 2 flexible arms, complete
consisting of
11-062
11-063
11-064



11-070
Brain retractor self retaining, with 1 flexible arm,
complete consisting of fixation base for 1 flexible
arm flexible arm only support for flat brain spatulas

11-071
Brain retractor self retaining, with 2 flexible arm,
complete consisting of fixation base for 2 flexible
arm flexible arm only support for flat brain spatulas



11-065
Fixation base only
holding 2 flexible arms
11-066
Support only for flat
brain spatulas

11-067
Fixation base only
holding 1 flexible arms
11-068
Support only for brain spatulas with round shaft of
4mm and 5mm to fix on the flexible arm
11-069
Flexible arm only for attaching
coupling heads and for fixation bases

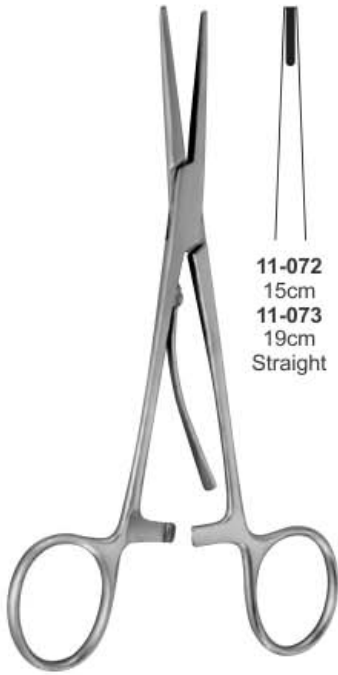

McKenzie Clip Applying Forceps

11-072
15cm
11-073
19cm
Straight

11-074
15cm
11-075
19cm
Curved



McKenzie 11-076
148mm x 40mm x 6mm
Brain clip rack for 20 clips



McKenzie Clip Applying Forceps 11-077
Straight Handle, Curved Jaws, 15cm



McKenzie Clip Applying Forceps 11-078
Curved Handle, Curved Jaws, 15cm



Smithwick Clip Applying Forceps
11-079 23 cm
11-080 26.5 cm
Curved Jaws
Straight Handle



Schwartz Clip Applying Forceps 11-081 20cm
Schwartz Vessel Clip



11-082
2.5cm Straight Jaws 1.7x 8mm



11-083
2.5cm Slightly Angled Jaws 1.7x 8mm



11-084
2.5cm Strong Angled Jaws 1.7x 8mm



Olivecrona Toennis (Scoville), Clip Forceps 11-085 14cm



11-087
Raney Hemostasis Clip



11-088
Kolner Scalp Clip

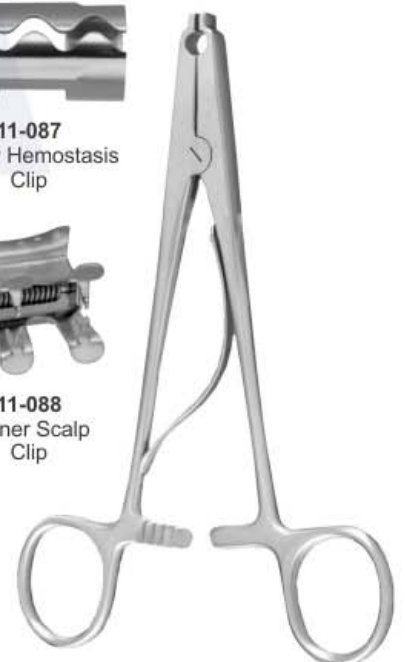

Raney Applyig & Removing Forceps 11-086 15cm

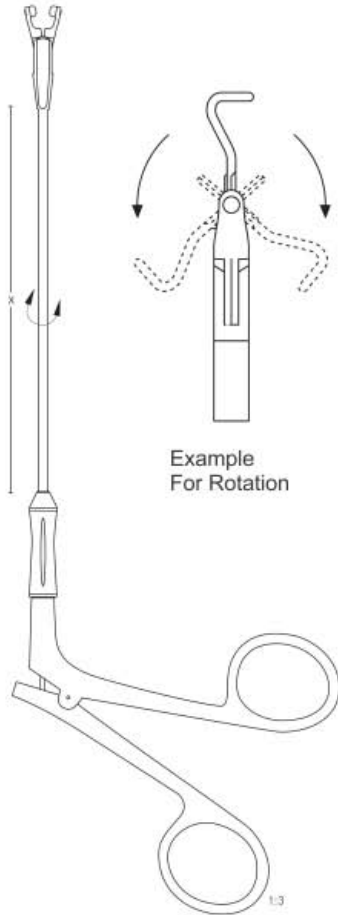

Example For Rotation

- Mini**
 11-089 7cm
 11-090 9cm
 11-091 11cm
 11-092 13cm
 non rotating
Standard
 11-093 7cm
 11-094 9cm
 11-095 11cm
 11-096 13cm
 non rotating

- Mini**
 11-097 7cm
 11-098 9cm
 11-099 11cm
 11-100 13cm
 rotating
Standard
 11-101 7cm
 11-102 9cm
 11-103 11cm
 11-104 13cm
 rotating



Applying Forceps

- Mini**
 11-105 18cm
 Straight with ratchet
Standard
 11-106 18cm
 Straight with ratchet

- Mini**
 11-107 17cm
 11-108 21cm
 11-109 23cm
 bayonett shaped, with ratchet
Standard
 11-110 17cm
 11-111 21cm
 11-112 23cm
 bayonett shaped, with ratchet

Applying Forceps



1:2

- Cushing, brain spatula**
 11-113 7mm x 9mm
 11-114 11mm x 13mm
 11-115 15mm x 18mm
 11-116 18mm x 22mm
 18cm



1:2

- Olivecrona**
 11-117
 brain spatula
 18cm



- Brain Spatula**
 11-118 7mm x 9mm
 11-119 11mm x 13mm
 11-120 15mm x 18mm
 11-121 18mm x 22mm
 18cm Convex



- Brain Spatula**
 11-122 7mm x 9mm
 11-123 11mm x 13mm
 11-124 15mm x 18mm
 11-125 18mm x 22mm
 18cm Concave



1:2

- Heifetz, brain spatula**
 11-126 8mm
 11-127 11mm
 11-128 14mm
 11-129 17mm
 11-130 20mm
 20cm Malleable

NERVE HOOKS



Scoville, Nerve Root Retractor
11-131 23cm
8mm



Holsher Nerve Root Retractor
11-132 24cm
7mm



Martin Nerve Root Retractor
11-133 21cm
7mm



Toennis Nerve Dura Hook



Halle Nerve Dura Hook
11-136 20cm



Smithwick Nerve Dura Hook
11-137 17cm
11-138 21cm



Hoen Nerve Dura Hook
11-139 22cm

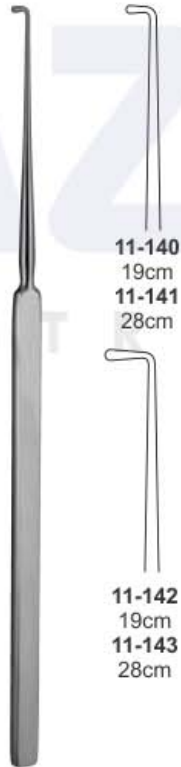

Cushing Nerve Dura Hook



Olivecrona Dura Dissector
11-144 18 cm



Olivecrona Dura Dissector
11-145 20 cm



Milligan Dura Dissector
11-146 21.5 cm



Davis Dura Dissector sharp
11-147 21.5 cm

Nervenhaken - Durahaken

Ganchos para nervios - Ganchos para duramadre

Crochets a nerfs - Crochets pour duremers

Uncini per nervi - Uncini per duramadre



Graham Nerve Dura Hook
11-148
18.5cm



Frazier Nerve Dura Hook
11-149
17cm



Dandy Nerve Dura Hook
11-150
20cm



Dandy Nerve Dura Hook
11-151
20cm



Dandy Nerve Dura Hook
11-152
20cm



Adson Nerve Dura Hook



11-153
20cm



11-154
20cm



Yasargil Nerve Dura Hook Retractor
11-155 21cm
11-156 41cm
Galea retractor



Love Nerve Dura Hook Retractor
11-157 19cm
Straight



Love Nerve Dura Hook Retractor
11-158 19cm
45° Angled



Love Nerve Dura Hook Retractor
11-159
19cm
90° Angled



Cushing Nerve Dura Hook Retractor
11-160 14cm



Frazier Nerve Dura Hook Retractor



11-161
13cm



11-162
18cm



Blunt



Lahey Nerve Dura Hook Retractor
11-163
13cm

Dura-Dissektoren

Disectores de duramadre

Decolleurs duremere

Dissetori per duramadre



Toennis Dura Dissector
11-164
25cm



Davis Dura Dissector
11-165
24.5cm



Dura Dissector
11-166 22cm



Sachs Dura Dissector
11-167 21cm



Sachs Dura Dissector
11-168 21cm



Sachs Dura Dissector
11-169
21cm



Horsley Dura Dissector
11-170
20cm



Smithwich Dura Dissector
11-171
30.5cm



Groningen
11-172
Nerve Hook
26.5 cm



Groningen
11-173
Nerve Hook
26.5 cm



11-174
A



11-175
B



Cushing
Nerve Hook blunt
19 cm

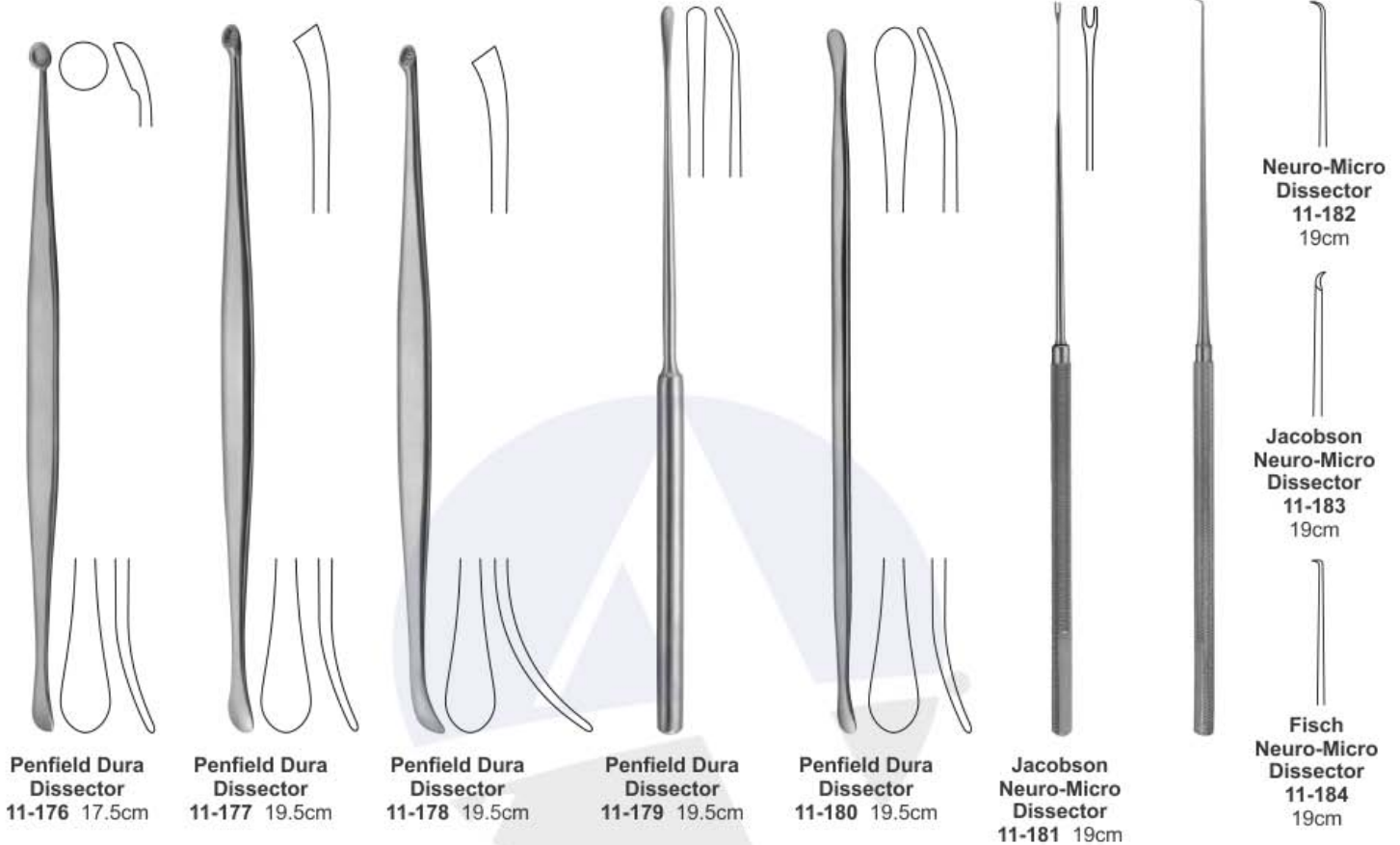

NEURO-DISSECTORS AND CURETTES





Yasargil Neuro-Micro Dissector



11-191
19cm
Straight
11-192
19cm
bayonet

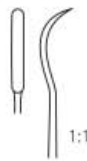

11-193
19cm
Straight
11-194
19cm
bayonet



11-195
19cm
Straight
11-196
19cm
bayonet



11-197
19cm
Straight
11-198
19cm
bayonet



11-199
19cm
Straight
11-200
19cm
bayonet



11-201
19cm
Straight
11-202
19cm
bayonet

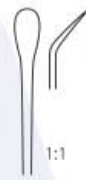

11-203
19cm
Straight
11-204
19cm
bayonet



11-205
19cm
Straight
11-206
19cm
bayonet



11-207
19cm
Straight
11-208
19cm
bayonet



11-209
19cm
Straight, with
Twist-fixationhook



11-210
19cm
Straight, with
Twist-fixationhook



Kraus
11-211
19cm
bayonet



Yasargil
11-212
19cm
bayonet



Koos
11-213
19cm
bayonet



Koos
11-214
19cm
bayonet



Koos
11-215
19cm
bayonet



Neuro-Micro Dissector

Laminektomiestanzen
Pincas emporte-pieces a laminectomie

Pinzas cortantes para laminectomia
Pinze taglienti per laminectomia



Cushing Intervertebral Disc Rongeurs
2 X 10mm, 15cm
11-216 straight
11-217 UP
11-218 Down



Love-Gruenwald Intervertebral Disc Rongeurs
3 X 10mm, 15cm
11-240 straight
11-241 Up
11-242 Down



Spurling Intervertebral Disc Rongeurs
4 X 10mm, 15cm
11-258 straight
11-259 Up
11-260 Down

1.5 X 10mm, 18cm
11-219 straight
11-220 Up
11-221 Down

3 X 10mm, 18cm
11-243 straight
11-244 Up
11-245 Down

4 X 10mm, 18cm
11-261 straight
11-262 Up
11-263 Down

2 X 10mm, 18cm
11-222 straight
11-223 UP
11-224 Down

3 X 10mm, 23cm
11-246 straight
11-247 Up
11-248 Down

4 X 10mm, 23cm
11-264 straight
11-265 Up
11-266 Down

1.5 X 10mm, 23cm
11-225 straight
11-226 Up
11-227 Down

3 X 10mm, 25.5cm
11-249 straight
11-250 Up
11-251 Down

4 X 10mm, 25.5cm
11-267 straight
11-268 Up
11-269 Down

2 X 10mm, 23cm
11-228 straight
11-229 UP
11-230 Down

3 X 10mm, 28cm
11-252 straight
11-253 Up
11-254 Down

4 X 10mm, 28cm
11-270 straight
11-271 Up
11-272 Down

2 X 10mm, 25.5cm
11-231 straight
11-232 UP
11-233 Down

3 X 10mm, 30.5cm
11-255 straight
11-256 Up
11-257 Down

4 X 10mm, 30.5cm
11-273 straight
11-274 Up
11-275 Down

2 X 10mm, 28cm
11-234 straight
11-235 UP
11-236 Down

2 X 10mm, 30.5cm
11-237 straight
11-238 UP
11-239 Down



- 11-276
- 11-277
- 11-278
- 11-279
- 11-280

Cushing
Laminectomy Rongeur jaw 2 x 10 to 4 x 10 mm straight shaft length 180 mm



- E
- 11-281
- D
- 11-282
- C
- 11-283
- B
- 11-284
- A
- 11-285

Cushing
Laminectomy Rongeur jaw 2 x 10 to 4 x 10 mm upwards 45 degree

**Wilde Intervertebral
Disc Rongeurs**

18cm Straight
11-286 2.5mm
11-287 3mm
11-288 4mm
11-289 5mm

18cm Angled up
11-290 2.5mm
11-291 3mm
11-292 4mm
11-293 5mm

23.5cm Straight
11-294 3mm
11-295 4mm
11-296 5mm

**Caspar Type Intervertebral
Disc Rongeurs**

16cm Straight
11-297 2 x 12mm
11-298 3 x 12mm
11-299 4 x 14mm
11-300 5 x 14mm
11-301 6 x 16mm

16cm Up
11-302 3 x 12mm
11-303 4 x 14mm
11-304 5 x 14mm

16cm Down
11-305 3 x 12mm
11-306 4 x 14mm

**Caspar Type Intervertebral
Disc Rongeurs**

18.5cm Straight
11-307 2 x 12mm
11-308 3 x 12mm
11-309 4 x 14mm
11-310 5 x 14mm
11-311 6 x 16mm

18.5cm Up
11-312 2 x 12mm
11-313 3 x 12mm
11-314 4 x 14mm
11-315 5 x 14mm

18.5cm Down
11-316 2 x 12mm
11-317 3 x 12mm
11-318 4 x 14mm

**Cushing Intervertebral
Disc Rongeurs**

w/teeth 2 x 10mm, 18cm
11-319 Straight
11-320 Up
11-321 Down

**L-G Intervertebral
Disc Rongeurs**

w/teeth 3 x 10mm, 18cm
11-322 Straight
11-323 Up
11-324 Down

 3 x 10mm, 25.5cm
11-325 Straight

**Schlesinger Intervertebral
Disc Rongeurs**

11-326 2 x 10mm, 13cm Straight
11-327 3 x 10mm, 13cm Straight
11-328 4 x 10mm, 13cm Straight
11-329 3 x 10mm, 13cm Angled Up

**Cloward Intervertebral
Disc Rongeurs**

serrated 6 x 10mm, 13cm
11-330 Straight
11-331 Up
11-332 Down

**Cushing Intervertebral
Disc Rongeurs**

2 X 10mm, 13cm
11-336 Straight
11-337 UP
11-338 Down

**Oldberg Intervertebral
Disc Rongeurs**

11-333 6mm Diameter
 18.5cm

**Selverstone Intervertebral
Disc Rongeurs**

11-334 2 x 3mm, 15cm
11-335 2 x 5mm, 15cm

**Love-Gruenwald
Intervertebral Disc Rongeurs**

3 X 10mm, 13cm
11-339 Straight
11-340 Up
11-341 Down

**Spurling Intervertebral
Disc Rongeurs**

4 X 10mm, 13cm
11-342 Straight
11-343 Up
11-344 Down



Decker Intervertebral Disc Rongeurs
2 x 5mm, 15cm
11-345 Right
11-346 Left
11-347 Down
11-348 Up
11-349 Straight



Jackson Intervertebral Disc Rongeurs
70° Up 18cm
11-350 2 x 8mm
11-351 3 x 8mm
11-352 4 x 8mm



Williams Style Micro Disc Intervertebral Disc Rongeurs
1 x 2 teeth, Straight
11-353 14cm
11-354 18cm
11-355 25.5cm



Micro Cup Forceps
14cm, 0.5mm
11-356 Straight
11-357 Right
11-358 Left

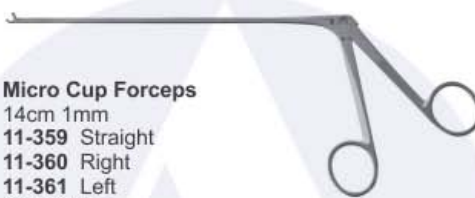

Micro Cup Forceps
14cm 1mm
11-359 Straight
11-360 Right
11-361 Left
14cm 2mm
11-362 Straight



Micro Cup Forceps
20.5cm, 2mm
11-363 Straight
11-364 Up
11-365 Down



Well Blakesley Laminectomy rongeurs

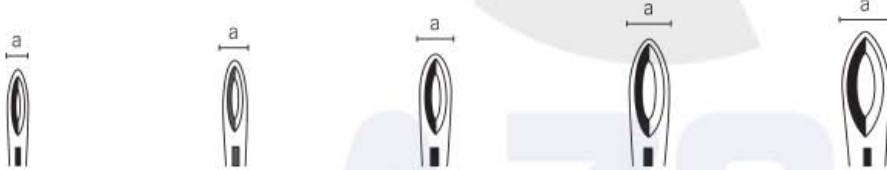

12cm
Straight

Fig. 1
3.0mm
11-366

Fig. 2
3.5mm
11-367

Fig. 3
4.5mm
11-368

Fig. 4
5.0mm
11-369

Fig. 5
5.5mm
11-370



12cm
45° up

11-371

11-372

11-373

11-374

11-375



12cm
90° up

11-376

11-377

11-378



18cm
45° up

Fig. 1
3.0mm
11-379

Fig. 2
3.5mm
11-380

Fig. 3
4.5mm
11-381

Fig. 4
5.0mm
11-382

Fig. 5
5.5mm
11-383



18cm 7"
90° up

11-384

11-385

11-386

11-387

Ferris Smith Micro Kerrison Laminectomy Rongeurs

45° UP 9mm bite opening 18cm

- 11-388 1mm
- 11-389 2mm
- 11-390 3mm
- 11-391 4mm
- 11-392 5mm
- 11-393 6mm

90° UP 9mm bite opening 20.5cm

- 11-394 1mm
- 11-395 2mm
- 11-396 3mm
- 11-397 4mm
- 11-398 5mm
- 11-399 6mm

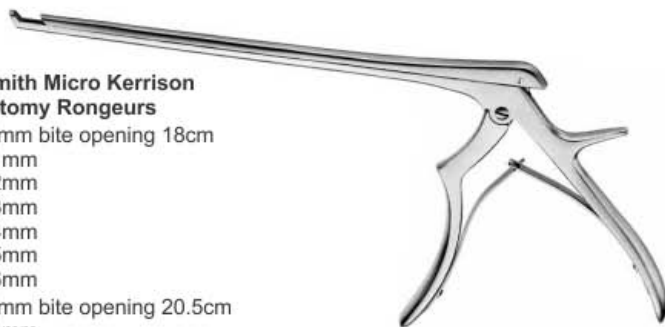

Ferris Smith Micro Kerrison Laminectomy Rongeurs

45° Down 9mm bite opening 18cm

- 11-400 1mm
- 11-401 2mm
- 11-402 3mm
- 11-403 4mm
- 11-404 5mm
- 11-405 6mm

90° Down 9mm bite opening, 20.5cm

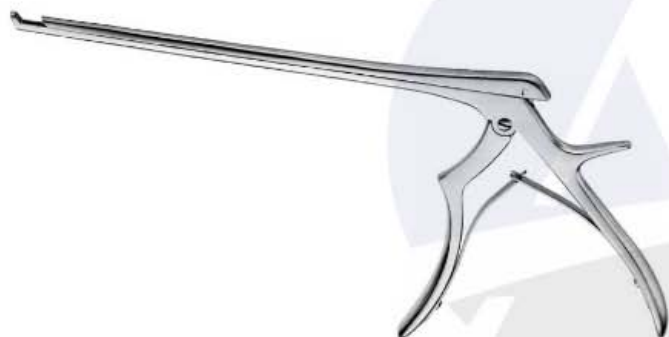
- 11-406 1mm
- 11-407 2mm
- 11-408 3mm
- 11-409 4mm
- 11-410 5mm
- 11-411 6mm

Ferris Smith Micro Kerrison Laminectomy Rongeurs UPWARD

40° UP

9mm bite opening, 18cm

- 11-412 1mm
- 11-413 2mm
- 11-414 3mm
- 11-415 4mm
- 11-416 5mm
- 11-417 6mm

40° UP

9mm bite opening, 23cm

- 11-435 1mm
- 11-436 2mm
- 11-437 3mm
- 11-438 4mm
- 11-439 5mm
- 11-440 6mm

40° Down

9mm bite opening, 18cm

- 11-418 2mm
- 11-419 3mm
- 11-420 4mm
- 11-421 5mm
- 11-422 6mm

40° UP

9mm bite opening, 25.5cm

- 11-441 2mm
- 11-442 3mm
- 11-443 4mm
- 11-444 5mm
- 11-445 6mm

40° UP

9mm bite opening, 20.5cm

- 11-423 1mm
- 11-424 2mm
- 11-425 3mm
- 11-426 4mm
- 11-427 5mm
- 11-428 6mm

40° UP

9mm bite opening,

- 11-446 2mm
- 11-447 3mm
- 11-448 4mm
- 11-449 5mm
- 11-450 6mm

40° Down

9mm bite opening, 20.5cm

- 11-429 1mm
- 11-430 2mm
- 11-431 3mm
- 11-432 4mm
- 11-433 5mm
- 11-434 6mm

40° UP

9mm bite opening, 30.5cm

- 11-451 2mm
- 11-452 3mm
- 11-453 4mm
- 11-454 5mm
- 11-455 6mm

Ferris Smith Micro Kerrison Laminectomy Rongeurs DOWNWARD

130° Down

9mm bite opening, 18cm

- 11-456 1mm
- 11-457 2mm
- 11-458 3mm
- 11-459 4mm
- 11-460 5mm
- 11-461 6mm

130° Down

9mm bite opening, 28cm

- 11-480 1mm
- 11-481 2mm
- 11-482 3mm
- 11-483 4mm
- 11-484 5mm
- 11-485 6mm

130° Down

9mm bite opening, 20.5cm

- 11-462 1mm
- 11-463 2mm
- 11-464 3mm
- 11-465 4mm
- 11-466 5mm
- 11-467 6mm

130° Down

9mm bite opening, 30.5cm

- 11-486 1mm
- 11-487 2mm
- 11-488 3mm
- 11-489 4mm
- 11-490 5mm
- 11-491 6mm

130° Down

9mm bite opening, 23cm

- 11-468 1mm
- 11-469 2mm
- 11-470 3mm
- 11-471 4mm
- 11-472 5mm
- 11-473 6mm

130° Down

9mm bite opening, 25.5cm

- 11-474 1mm
- 11-475 2mm
- 11-476 3mm
- 11-477 4mm
- 11-478 5mm
- 11-479 6mm

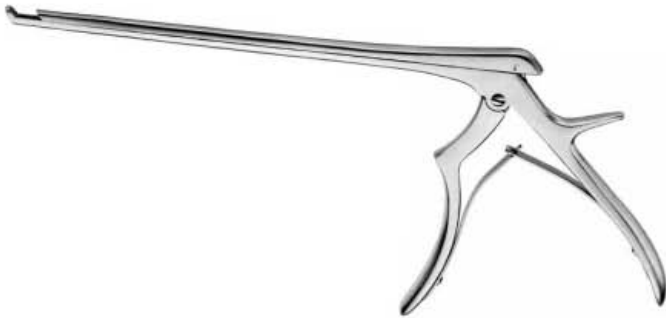

**Micro Ejector Kerrison
Laminectomy Rongeurs**

40° Up 20.5cm
11-492 2mm
11-493 3mm
11-494 4mm
11-495 5mm
11-496 6mm

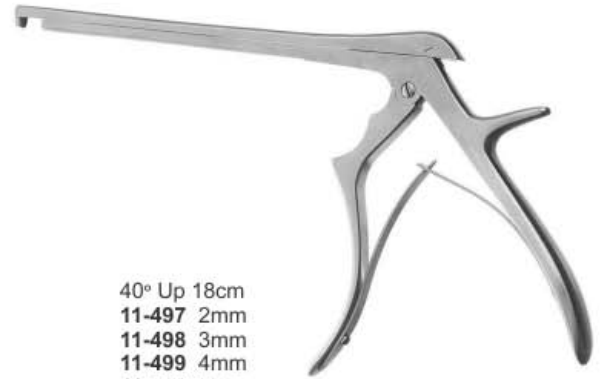

**Wide Mouth Ejector Kerrison
Laminectomy Rongeurs**

40° Up 18cm
11-497 2mm
11-498 3mm
11-499 4mm
11-500 5mm
11-501 6mm

40° Up 20.5cm
11-502 2mm
11-503 3mm
11-504 4mm
11-505 5mm
11-506 6mm



**Spurling Kerrison
Laminectomy Rongeurs
Large Handle**

40° UP,
 15mm Bite Opening, 18cm
11-507 2mm
11-508 3mm
11-509 4mm
11-510 5mm
11-511 6mm



**Spurling Kerrison
Laminectomy Rongeurs
Large Handle**

40° UP,
 15mm Bite Opening, 25.5cm
11-522 2mm
11-523 3mm
11-524 4mm
11-525 5mm
11-526 6mm



**Spurling Kerrison
Laminectomy Rongeurs
Large Handle**

90° Down,
 15mm Bite Opening, 18cm
11-542 2mm
11-543 3mm
11-544 4mm
11-545 5mm
11-546 6mm

40° UP,
 15mm Bite Opening, 20.5cm
11-512 2mm
11-513 3mm
11-514 4mm
11-515 5mm
11-516 6mm

40° UP,
 15mm Bite Opening, 28cm
11-527 2mm
11-528 3mm
11-529 4mm
11-530 5mm
11-531 6mm

90° UP,
 15mm Bite Opening, 20.5cm
11-537 2mm
11-538 3mm
11-539 4mm
11-540 5mm
11-541 6mm

90° Down,
 15mm Bite Opening, 20.5cm
11-547 2mm
11-548 3mm
11-549 4mm
11-550 5mm
11-551 6mm

40° UP,
 15mm Bite Opening, 23cm
11-517 2mm
11-518 3mm
11-519 4mm
11-520 5mm
11-521 6mm



Foramenotomy Kerrison

Laminectomy Rongeurs, Curved

- 11-552 UP, 9mm Bite opening, 20.5cm 2mm
- 11-553 UP, 9mm Bite opening, 20.5cm 3mm
- 11-554 UP, 9mm Bite opening, 20.5cm 4mm
- 11-555 UP, 9mm Bite opening, 20.5cm 5mm
- 11-556 UP, 9mm Bite opening, 20.5cm 6mm
- 11-557 Left, 9mm Bite opening, 20.5cm 6mm
- 11-558 Right, 9mm Bite opening, 20.5cm 6mm

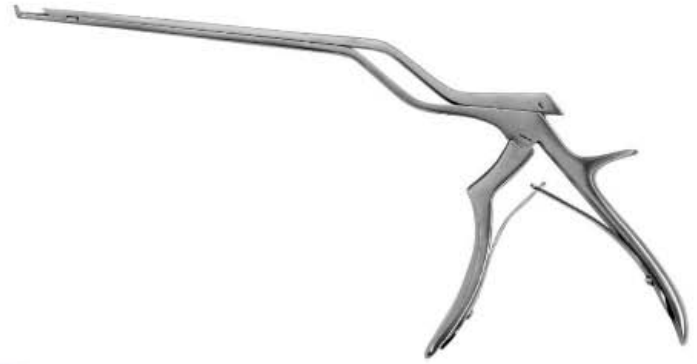

**Bayonet Micro Kerrison
Laminectomy Rongeurs**

- 40° Up, 150 mm Working Length 20.5cm
- 11-559 1mm
- 11-560 2mm
- 11-561 3mm
- 11-562 4mm
- 11-563 5mm
- 11-564 6mm

- 90° Up, 150 mm Working Length 20.5cm
- 11-565 1mm
- 11-566 2mm
- 11-567 3mm
- 11-568 4mm
- 11-569 5mm
- 11-570 6mm



Spurling Laminectomy Rongeurs

**Bayonet Spurling Kerrison
Laminectomy Rongeurs**

- 40° Up, 150 mm Working Length 20.5cm
- 11-571 1mm
- 11-572 2mm
- 11-573 3mm
- 11-574 4mm
- 11-575 5mm
- 11-576 6mm

- 90° Up, 150 mm Working Length 20.5cm
- 11-577 1mm
- 11-578 2mm
- 11-579 3mm
- 11-580 4mm
- 11-581 5mm
- 11-582 6mm

- 40° UP, 15mm Bite Opening, 18cm
- 11-583 2mm
- 11-584 3mm
- 11-585 4mm
- 11-586 5mm
- 11-587 6mm

- 40° UP, 15mm Bite Opening, 23cm
- 11-593 2mm
- 11-594 3mm
- 11-595 4mm
- 11-596 5mm
- 11-597 6mm

- 40° UP, 15mm Bite Opening, 20.5cm
- 11-588 2mm
- 11-589 3mm
- 11-590 4mm
- 11-591 5mm
- 11-592 6mm

- 40° UP, 15mm Bite Opening, 25.5cm
- 11-598 2mm
- 11-599 3mm
- 11-600 4mm
- 11-601 5mm
- 11-602 6mm

- 40° UP, 15mm Bite Opening, 28cm
- 11-603 2mm
- 11-604 3mm
- 11-605 4mm
- 11-606 5mm
- 11-607 6mm

Laminektomiestanzen

Pinces emporte-pieces a laminectomie

Pinzas cortantes para laminectomia

Pinze taglienti per laminectomia

90° UP, 15mm Bite Opening, 18cm
11-608 2mm
11-609 3mm
11-610 4mm
11-611 5mm
11-612 6mm



Spurling Laminectomy Rongeurs

90° UP, 15mm Bite Opening, 20.5cm
11-613 2mm
11-614 3mm
11-615 4mm
11-616 5mm
11-617 6mm

90° Down, 15mm Bite Opening, 18cm
11-618 2mm
11-619 3mm
11-620 4mm
11-621 5mm
11-622 6mm



Spurling Laminectomy Rongeurs

90° Down, 15mm Bite Opening, 20.5cm
11-623 2mm
11-624 3mm
11-625 4mm
11-626 5mm
11-627 6mm

Micro Ejector Kerrison Laminectomy Rongeurs

40° Up 20.5cm
11-628 2mm
11-629 3mm
11-630 4mm
11-631 5mm
11-632 6mm

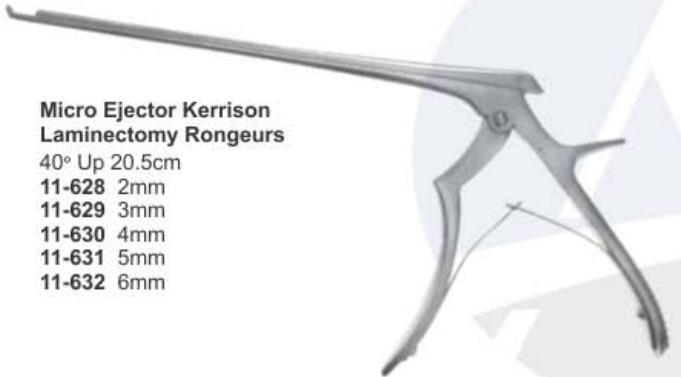

Wide Mouth Ejector Kerrison Laminectomy Rongeurs

40° Up 18cm	40° Up 20.5cm
11-633 2mm	11-638 2mm
11-634 3mm	11-639 3mm
11-635 4mm	11-640 4mm
11-636 5mm	11-641 5mm
11-637 6mm	11-642 6mm



Ferris Smith Micro Kerrison Laminectomy Rongeurs

130° Down Bite, 28cm
11-643 4mm
11-644 5mm
11-645 6mm

130° Down Bite, 30.5cm
11-646 1mm
11-647 2mm
11-648 3mm
11-649 4mm
11-650 5mm
11-651 6mm



Spurling Intervertebral Disc Rongeurs

w/teeth 4 x 10mm, 18cm
11-652 Straight
11-653 Up
11-654 Down

4 x 10mm, 25.5cm
11-655 Straight

5 x 10mm, 25.5cm
11-656 Straight



Kerrison Cervical Rongeur

11-657
 17.8 cm shaft, 3 mm
 40 degree forward angle



Schlesinger Cervical Rongeur

11-658
 thin tips, 15 cm shaft, up-bite, 3 mm





Ferris-Smith Intervertebral Disc Rongeurs
 18cm straight
 11-659 2 x 10mm
 11-660 3 x 10mm
 11-661 4 x 8mm
 11-662 4 x 10mm
 11-663 6 x 10mm
 11-664 6 x 12mm

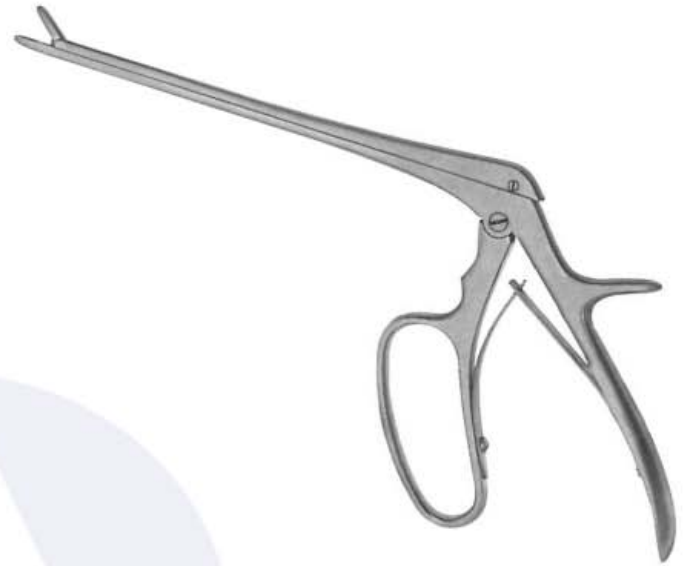

Ferris-Smith Intervertebral Disc Rongeurs
 18cm Up
 11-665 2 x 10mm
 11-666 3 x 10mm
 11-667 4 x 10mm
 11-668 6 x 10mm

18cm Down
 11-669 2 x 10mm
 11-670 3 x 10mm
 11-671 4 x 10mm
 11-672 6 x 10mm







Peapod Intervertebral Disc Rongeurs, 14cm
 11-673 Angle up 1.5mm, x-small
 11-674 Angle up 2mm, small
 11-675 Angle up 2.5mm, medium
 11-676 Angle up 3mm, large

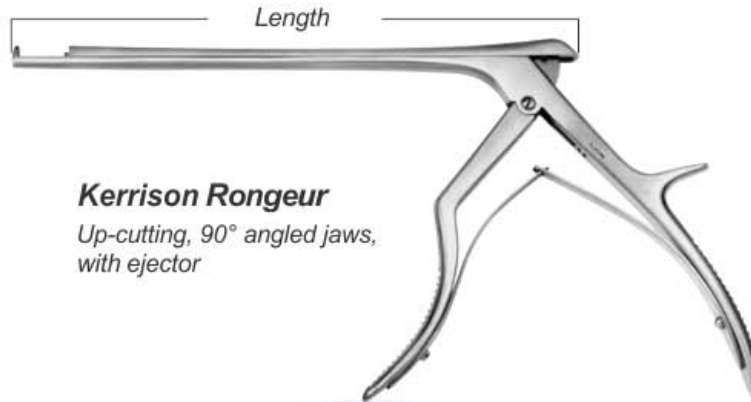

Peapod Intervertebral Disc Rongeurs,
 11-677 Angle up 2.5mm, 18cm
 11-678 Angle up 3mm, 18cm
 11-679 Angle up 4mm, 18cm
 11-680 Straight 2mm, 14cm
 11-681 Straight 2.5mm, 14cm
 11-682 Straight 3mm, 14cm

Kerrison Rongeur
*Up-cutting, 90° angled jaws,
with ejector*

<i>Ferris-Smith Kerrison handle</i>	<i>Kerrison Small handle</i>	<i>Kerrison Large handle</i>	 <i>Jaw size (width x height) Length*</i>	
				
		11-707	2,0 x 2,0 mm	18 cm
11-683	11-695	11-708	2,5 x 2,5 mm	18 cm
11-684	11-696	11-709	2,0 x 3,0 mm	18 cm
11-685	11-697	11-710	3,0 x 4,0 mm	18 cm
11-686	11-698	11-711	4,0 x 5,0 mm	18 cm
11-687	11-699	11-712	5,0 x 5,0 mm	18 cm
11-688	11-700	11-713	6,0 x 5,0 mm	18 cm
		11-714	7,0 x 6,0 mm	18 cm
		11-715	2,0 x 2,0 mm	20 cm
11-689	11-701	11-716	2,5 x 2,5 mm	20 cm
11-690	11-702		2,0 x 3,0 mm	20 cm
11-691	11-703	11-717	3,0 x 4,0 mm	20 cm
11-692	11-704	11-718	4,0 x 5,0 mm	20 cm
11-693	11-705	11-719	5,0 x 5,0 mm	20 cm
11-694	11-706	11-720	6,0 x 5,0 mm	20 cm
		11-721	7,0 x 6,0 mm	20 cm
		11-722	2,0 x 2,0 mm	22 cm
		11-723	2,5 x 2,5 mm	22 cm
		11-724	2,0 x 3,0 mm	22 cm
		11-725	3,0 x 4,0 mm	22 cm
		11-726	4,0 x 5,0 mm	22 cm
		11-727	5,0 x 5,0 mm	22 cm
		11-728	6,0 x 5,0 mm	22 cm
		11-729	7,0 x 6,0 mm	22 cm
		11-730	2,0 x 2,0 mm	25 cm
		11-731	2,0 x 3,0 mm	25 cm
		11-732	3,0 x 4,0 mm	25 cm
		11-733	4,0 x 5,0 mm	25 cm
		11-734	5,0 x 5,0 mm	25 cm
		11-735	2,0 x 2,0 mm	30 cm
		11-736	3,0 x 4,0 mm	30 cm
		11-737	4,0 x 5,0 mm	30 cm
		11-738	5,0 x 5,0 mm	30 cm

Maulgrößen / Jaw sizes:







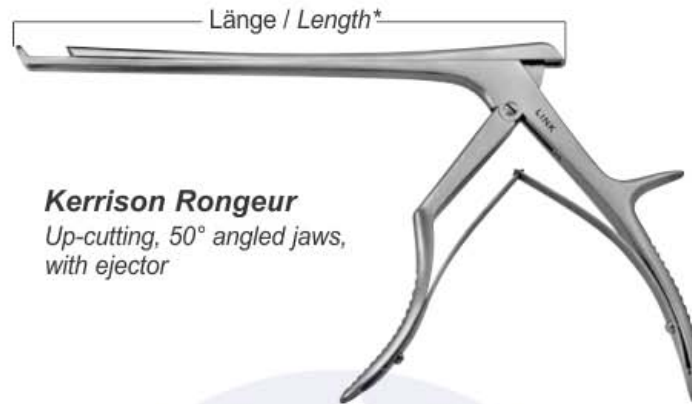







- 2,0 x 2,0 mm
- 2,5 x 2,5 mm
- 2,0 x 3,0 mm
- 3,0 x 4,0 mm
- 4,0 x 5,0 mm
- 5,0 x 5,0 mm
- 6,0 x 5,0 mm
- 7,0 x 6,0 mm

* Lengths are measured with closed jaws



Kerrison Rongeur
Up-cutting, 50° angled jaws,
with ejector

<i>Ferris-Smith Kerrison handle</i>	<i>Kerrison Small handle</i>	<i>Kerrison Large handle</i>		
			<i>Jaw size (width x height)</i>	<i>Length*</i>
		11-763	2,0 x 2,0 mm	18 cm
11-739	11-751	11-764	2,5 x 2,5 mm	18 cm
11-740	11-752		2,0 x 3,0 mm	18 cm
11-741	11-753	11-765	3,0 x 4,0 mm	18 cm
11-742	11-754	11-766	4,0 x 5,0 mm	18 cm
11-743	11-755	11-767	5,0 x 5,0 mm	18 cm
11-744	11-756	11-768	6,0 x 5,0 mm	18 cm
		11-769	7,0 x 6,0 mm	18 cm
		11-770	2,0 x 2,0 mm	20 cm
11-745	11-757	11-771	2,5 x 2,5 mm	20 cm
11-746	11-758	11-772	2,0 x 3,0 mm	20 cm
11-747	11-759	11-773	3,0 x 4,0 mm	20 cm
11-748	11-760	11-774	4,0 x 5,0 mm	20 cm
11-749	11-761	11-775	5,0 x 5,0 mm	20 cm
11-750	11-762	11-776	6,0 x 5,0 mm	20 cm
		11-777	7,0 x 6,0 mm	20 cm
Maulgrößen / Jaw sizes:		11-778	2,0 x 2,0 mm	22 cm
	2,0 x 2,0 mm	11-779	2,5 x 2,5 mm	22 cm
	2,5 x 2,5 mm	11-780	3,0 x 4,0 mm	22 cm
	2,0 x 3,0 mm	11-781	4,0 x 5,0 mm	22 cm
	3,0 x 4,0 mm	11-782	5,0 x 5,0 mm	22 cm
	4,0 x 5,0 mm	11-783	6,0 x 5,0 mm	22 cm
	5,0 x 5,0 mm	11-784	7,0 x 6,0 mm	22 cm
	6,0 x 5,0 mm	11-785	2,0 x 2,0 mm	25 cm
	7,0 x 6,0 mm	11-786	3,0 x 4,0 mm	25 cm
		11-787	4,0 x 5,0 mm	25 cm
		11-788	5,0 x 5,0 mm	25 cm
		11-789	2,0 x 2,0 mm	30 cm
		11-790	3,0 x 4,0 mm	30 cm
		11-791	4,0 x 5,0 mm	30 cm
		11-792	5,0 x 5,0 mm	30 cm

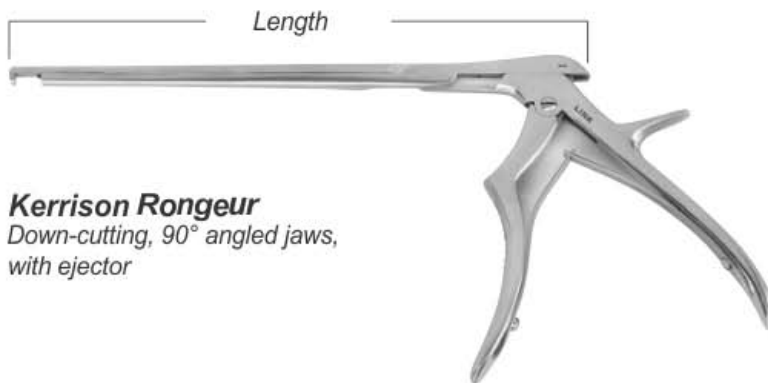

*Lengths are measured with closed jaws



Kerrison Rongeur
Down-cutting, 90° angled jaws,
with ejector





Ferris-Smith Kerrison handle	Kerrison Small handle	Kerrison Large handle		
			Jaw size (width x height)	Length*
		11-817	2,0 x 2,0 mm	18 cm
11-793	11-805	11-818	2,5 x 2,5 mm	18 cm
11-794	11-806		2,0 x 3,0 mm	18 cm
11-795	11-807	11-819	3,0 x 4,0 mm	18 cm
11-796	11-808	11-820	4,0 x 5,0 mm	18 cm
11-797	11-809	11-821	5,0 x 5,0 mm	18 cm
11-798	11-810	11-822	6,0 x 5,0 mm	18 cm
		11-823	7,0 x 6,0 mm	18 cm
		11-824	2,0 x 2,0 mm	20 cm
11-799	11-811	11-825	2,5 x 2,5 mm	20 cm
11-800	11-812	11-826	2,0 x 3,0 mm	20 cm
11-801	11-813	11-827	3,0 x 4,0 mm	20 cm
11-802	11-814	11-828	4,0 x 5,0 mm	20 cm
11-803	11-815	11-829	5,0 x 5,0 mm	20 cm
11-804	11-816	11-830	6,0 x 5,0 mm	20 cm
		11-831	7,0 x 6,0 mm	20 cm
		11-832	2,0 x 2,0 mm	22 cm
		11-833	2,5 x 2,5 mm	22 cm
		11-834	2,0 x 3,0 mm	22 cm
		11-835	3,0 x 4,0 mm	22 cm
		11-836	4,0 x 5,0 mm	22 cm
		11-837	5,0 x 5,0 mm	22 cm
		11-838	6,0 x 5,0 mm	22 cm
		11-839	7,0 x 6,0 mm	22 cm
		11-840	2,0 x 2,0 mm	25 cm
		11-841	2,0 x 3,0 mm	25 cm
		11-842	3,0 x 4,0 mm	25 cm
		11-843	4,0 x 5,0 mm	25 cm
		11-844	5,0 x 5,0 mm	25 cm
		11-845	2,0 x 2,0 mm	30 cm
		11-846	2,0 x 3,0 mm	30 cm
		11-847	3,0 x 4,0 mm	30 cm
		11-848	4,0 x 5,0 mm	30 cm
		11-849	5,0 x 5,0 mm	30 cm

Maulgrößen/ Jaw sizes:

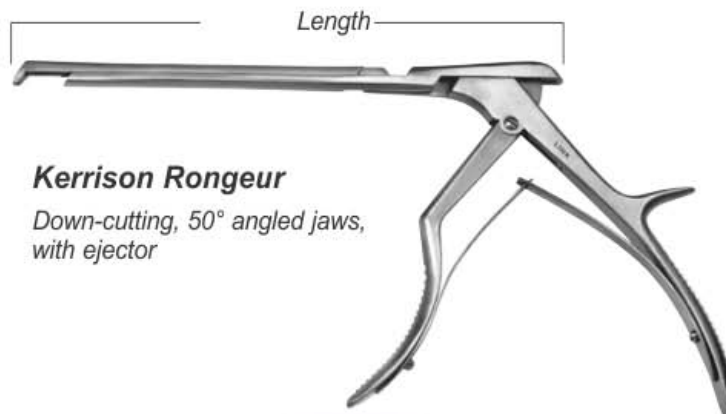







-  2,0 x 2,0 mm
-  2,5 x 2,5 mm
-  2,0 x 3,0 mm
-  3,0 x 4,0 mm
-  4,0 x 5,0 mm
-  5,0 x 5,0 mm
-  6,0 x 5,0 mm
-  7,0 x 6,0 mm

* Lengths are measured with closed jaws

Laminektomiestanzen
Pinces emporte-pieces a laminectomie
Pinzas cortantes para laminectomia
Pinze taglienti per laminectomia

Kerrison Rongeur
Down-cutting, 50° angled jaws, with ejector

<i>Ferris-Smith Kerrison handle</i>	<i>Kerrison Small handle</i>	<i>Kerrison Large handle</i>		
			<i>Jaw size (width x height)</i>	<i>Length*</i>
		11-874	2,0 x 2,0 mm	18 cm
11-850	11-862	11-875	2,5 x 2,5 mm	18 cm
11-851	11-863	11-876	2,0 x 3,0 mm	18 cm
11-852	11-864	11-877	3,0 x 4,0 mm	18 cm
11-853	11-865	11-878	4,0 x 5,0 mm	18 cm
11-854	11-866	11-879	5,0 x 5,0 mm	18 cm
11-855	11-867	11-880	6,0 x 5,0 mm	18 cm
		11-881	7,0 x 6,0 mm	18 cm
		11-882	2,0 x 2,0 mm	20 cm
11-856	11-868	11-883	2,5 x 2,5 mm	20 cm
11-857	11-869		2,0 x 3,0 mm	20 cm
11-858	11-870	11-884	3,0 x 4,0 mm	20 cm
11-859	11-871	11-885	4,0 x 5,0 mm	20 cm
11-860	11-872	11-886	5,0 x 5,0 mm	20 cm
11-861	11-873	11-887	6,0 x 5,0 mm	20 cm
		11-888	7,0 x 6,0 mm	20 cm
		11-889	2,0 x 2,0 mm	22 cm
		11-890	2,5 x 2,5 mm	22 cm
		11-891	2,0 x 3,0 mm	22 cm
		11-892	3,0 x 4,0 mm	22 cm
		11-893	4,0 x 5,0 mm	22 cm
		11-894	5,0 x 5,0 mm	22 cm
		11-895	6,0 x 5,0 mm	22 cm
		11-896	7,0 x 6,0 mm	22 cm
		11-897	2,0 x 2,0 mm	25 cm
		11-898	2,0 x 3,0 mm	25 cm
		11-899	3,0 x 4,0 mm	25 cm
		11-900	4,0 x 5,0 mm	25 cm
		11-901	5,0 x 5,0 mm	25 cm
		11-902	2,0 x 2,0 mm	30 cm
		11-903	2,0 x 3,0 mm	30 cm
		11-904	3,0 x 4,0 mm	30 cm
		11-905	4,0 x 5,0 mm	30 cm
		11-906	5,0 x 5,0 mm	30 cm

Maulgrößen Jaw sizes:

-  2,0 x 2,0 mm
-  2,5 x 2,5 mm
-  2,0 x 3,0 mm
-  3,0 x 4,0 mm
-  4,0 x 5,0 mm
-  5,0 x 5,0 mm
-  6,0 x 5,0 mm
-  7,0 x 6,0 mm

**Lengths are measured with closed jaws*

Laminektomiestanzen
Pincas emporte-pieces a laminectomie

Pinzas cortantes para laminectomia
Pinze taglienti per laminectomia

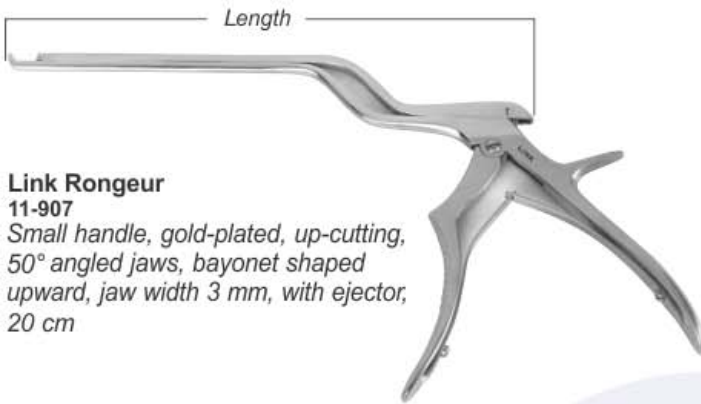

Link Rongeur
11-907
Small handle, gold-plated, up-cutting, 50° angled jaws, bayonet shaped upward, jaw width 3 mm, with ejector, 20 cm

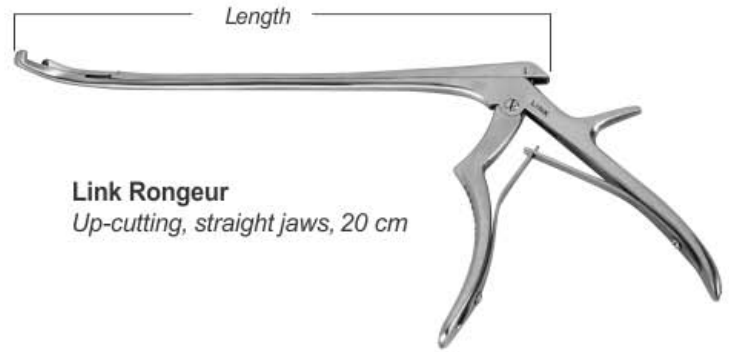

Link Rongeur
Up-cutting, straight jaws, 20 cm

Curved to left	Curved to right	Jaw size (width x height)
		3,0 x 4,0 mm
11-908	11-911	4,0 x 4,0 mm
11-909	11-912	5,0 x 4,0 mm
11-910	11-913	

Lengths are measured with closed jaws



LINK-Beatty Rongeur
Shank curved 70° / 90° upward, up-cutting, 20 cm

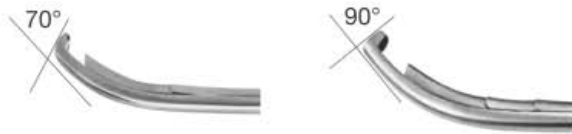

		Jaw size (width x height)
11-914	11-918	2,0 x 3,0 mm
11-915	11-919	3,0 x 4,0 mm
11-916	11-920	4,0 x 4,0 mm
11-917	11-921	5,0 x 4,0 mm

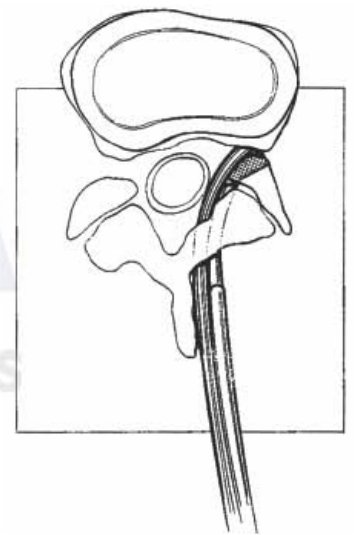

Lengths are measured with closed jaws



The angled LINK-Beatty Rongeur allows to perform foraminotomies while preserving dorsal processes and facet joints.



**LINK SimpleClean™
Kerrison Rongeur**
*Small handle, SimpleClean™
mechanism, up-cutting*

<i>50° angled jaws thin footplate</i>			<i>50° angled jaws</i>		
	<i>Jaw width</i>	<i>Length*</i>		<i>Jaw width</i>	<i>Length*</i>
11-922	2 mm	18 cm	11-934	2 mm	18 cm
11-923	3 mm	18 cm	11-935	3 mm	18 cm
11-924	4 mm	18 cm	11-936	4 mm	18 cm
11-925	5 mm	18 cm	11-937	5 mm	18 cm
			11-938	6 mm	18 cm
11-926	2 mm	20 cm	11-939	2 mm	20 cm
11-927	3 mm	20 cm	11-940	3 mm	20 cm
11-928	4 mm	20 cm	11-941	4 mm	20 cm
11-929	5 mm	20 cm	11-942	5 mm	20 cm
			11-943	6 mm	20 cm
11-930	2 mm	23 cm	11-944	2 mm	23 cm
11-931	3 mm	23 cm	11-945	3 mm	23 cm
11-932	4 mm	23 cm	11-946	4 mm	23 cm
11-933	5 mm	23 cm	11-947	5 mm	23 cm
			11-948	6 mm	23 cm

Lengths are measured with closed jaws



The SimpleClean™ mechanism makes cleaning of the Rongeurs an easy matter

To open the SimpleClean™ mechanism pull the handle, turn the release and lift up the pusher.

The coloured release help to recognize more easily the individual widths of the jaw.

Laminektomiestanzen

Pinzas cortantes para laminectomia

Pinces emporte-pieces a laminectomie

Pinze taglienti per laminectomia



40° UPWARD

Black Line' Kerrison Laminectomy Punch
40° UPWARD Jaw angle
with special titanium coating on surface
Bone ejector



Reduced footplate

40° UPWARD

Thin Footplate Kerrison Laminectomy Punch
40° UPWARD Jaw angle
Thin Footplate For cervical surgery

40° UPWARD JAW

18cm/7" Shaft	20cm/8" Shaft	23cm/9" Shaft	Bite Size
11-949	11-955	11-961	1mm
11-950	11-956	11-962	2mm
11-951	11-957	11-963	3mm
11-952	11-958	11-964	4mm
11-953	11-959	11-965	5mm
11-954	11-960	11-966	6mm

40° UPWARD JAW

18cm/7" Shaft	20cm/8" Shaft	Bite Size
11-967	11-972	2mm
11-968	11-973	3mm
11-969	11-974	4mm
11-970	11-975	5mm
11-971	11-976	6mm

A reduced footplate thickness useful for a restricted operating area

40° UPWARD



Ferris-Smith Kerrison Laminectomy Punch
40° UPWARD Jaw angle
Modified ring handle

40° UPWARD JAW

18cm/7" Shaft	20cm/8" Shaft	Bite Size
11-977	11-982	2mm
11-978	11-983	3mm
11-979	11-984	4mm
11-980	11-985	5mm
11-981	11-986	6mm

40° UPWARD



Long Anterior Kerrison Laminectomy Punch
40° UPWARD Jaw angle
with special Titanium coating on surface
Extra long shaft for Thoracic approach
Bone ejector

40° UPWARD JAW

28cm/11" Shaft	Bite Size
11-987	2mm
11-988	3mm
11-989	4mm
11-990	5mm
11-991	6mm

Brain Retractors Set

Conjunto de retractores cerebrales

Ensemble d'écarteurs cérébraux

Set di divaricatori per cervello



11-992
Book Walter Retractor
Complete Set with Box



11-993
Book Walter Retractor
Complete Set with Wooden Box



11-994
Leyla
Self-Retaining Brain Retractor

CARDIOVASCULAR & THORACIC INSTRUMENTS

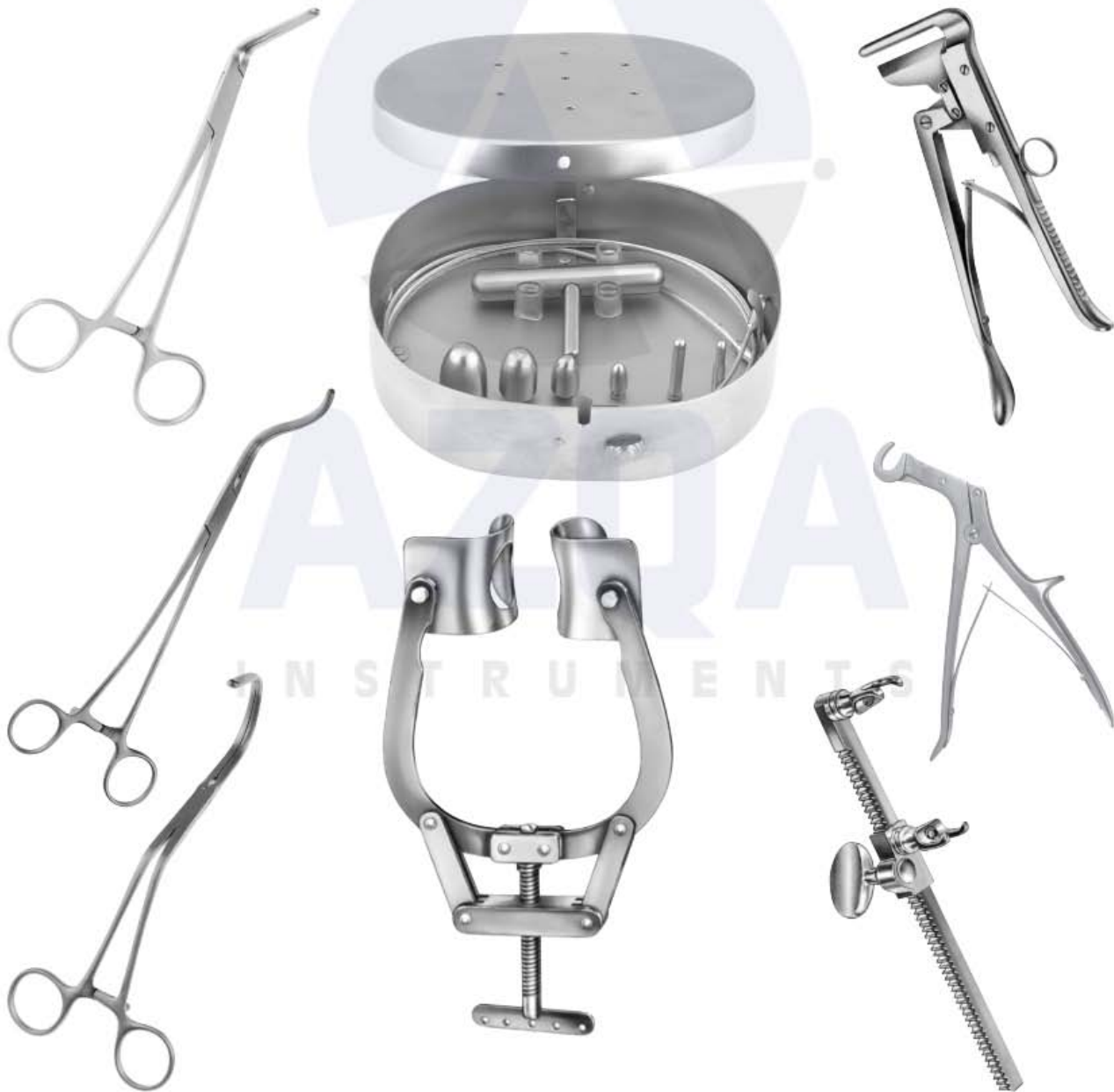

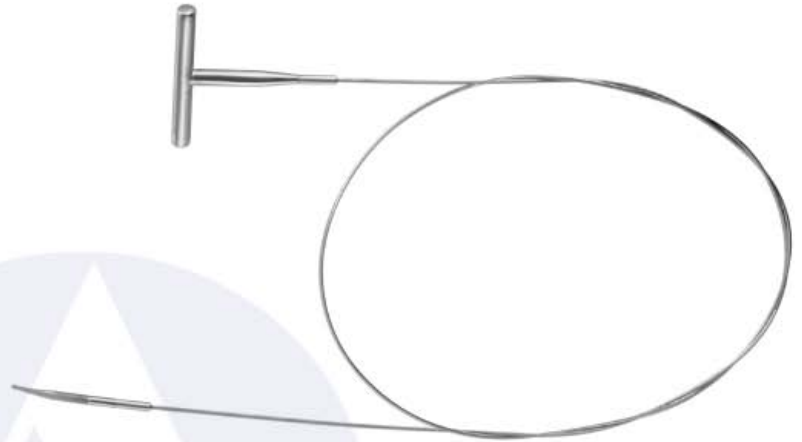
Nabatoff Varicose Vein Stripper
12-001
 135mmx100mmx25mm

complete

12-002
Nabatoff
 Metal Case

12-003
Nabatoff
 Handle

12-004
Nabatoff
 Cable 900mm



3mm



6mm



9mm



12mm

12-005
Nabatoff
 Probe tip in plastic

 AZQA
 INSTRUMENTS

Nabatoff
Metal Probe
12-006
 3mm

Nabatoff
Metal Olive
12-007
 6mm

Nabatoff
Metal Olive
12-008
 9mm

Nabatoff
Metal Olive
12-009
 12mm

Nabatoff
Metal Olive
12-010
 15mm



De Bakey

12-011
7.5 cm



12-012
8.5 cm



12-013
10 cm



12-014
12 cm



De Bakey



12-015
7.5 cm



12-016
8.5 cm



12-017
9.5 cm

12-018
11 cm



Glover



12-020
7 cm



12-021
8 cm



12-022
9.5 cm



12-023
11 cm

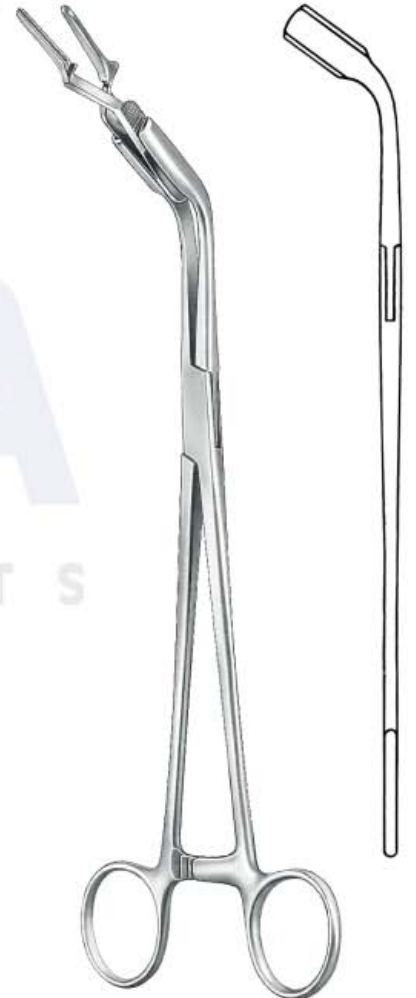

**Applying forceps
for bulldog clamps**
12-019
24 cm



Glover



12-024
6.5 cm



12-025
7.5 cm



12-026
9 cm



12-027
10.5 cm



De Bakey
2.7 mm



12-028
16 cm



12-029
20 cm



De Bakey
1.5 mm



12-032
16 cm



12-033
20 cm



De Bakey
2 mm



12-035
16 cm



12-036
20 cm



12-030
25 cm



12-031
30 cm



12-034
25 cm



12-037
24 cm



12-038
30 cm



De Bakey
2 mm



12-039
16 cm



12-040
19.5 cm



De Bakey
3.5 mm



12-043
16 cm



12-044
20 cm



Cooley
2.0 mm



12-047
16 cm



12-041
25 cm



12-042
30 cm



12-045
25 cm



12-046
30 cm



12-048
20 cm

Hemostatic forceps



De Bakey-Rankin
16 cm



12-049
Straight



12-050
Curved



De Bakey-Mosquito
15 cm



12-051
Straight



12-052
Curved



Ochsner
12-053
22 cm



Diethrich
12-054
21 cm

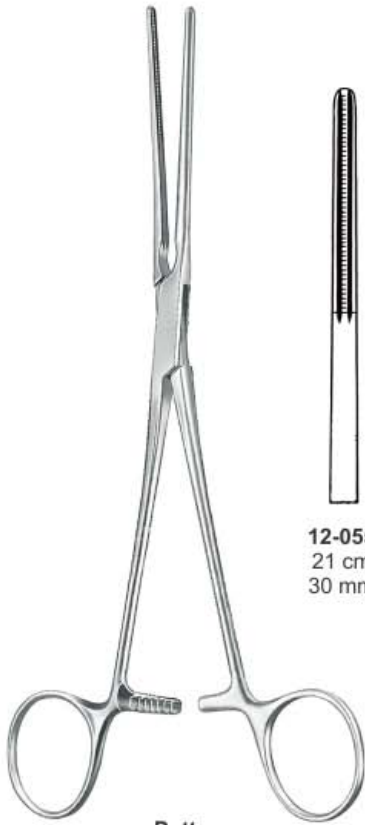

12-055
21 cm
30 mm

Potts



12-056
22.5 cm
55 mm



Potts



12-057
20.5 cm
angled
30 mm

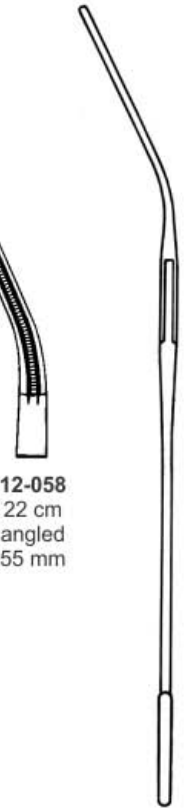

12-058
22 cm
angled
55 mm



Potts

12-059
20.5 cm
angled
30 mm



12-060
22 cm
angled
55 mm



Potts
12-061
21.5 cm
55 mm



Anastomosenklemmen, Ligaturklemmen

Pinzas para anastomosis, Pinzas para ligaduras

Pinces-clamps à anastomose, Pinces à ligatures

Morsetti per anastomosi, pinze per legature



Potts
12-062
22 cm
55 mm



De Bakey



12-063
19 cm



12-064
24 cm



De Bakey
12-065
16 cm



De Bakey
12-066
19 cm

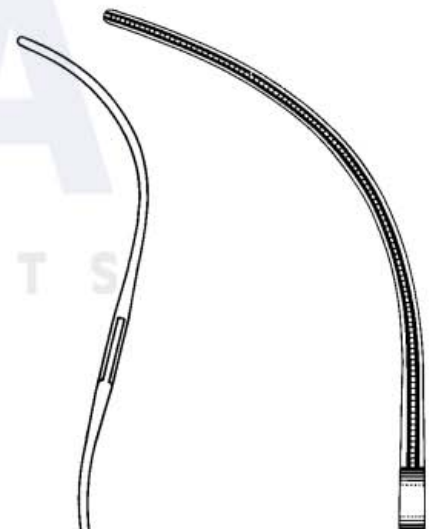

Multi purpose Vascular Clamps



De Bakey
12-067
20 cm



De Bakey
12-068
angled, 20 cm

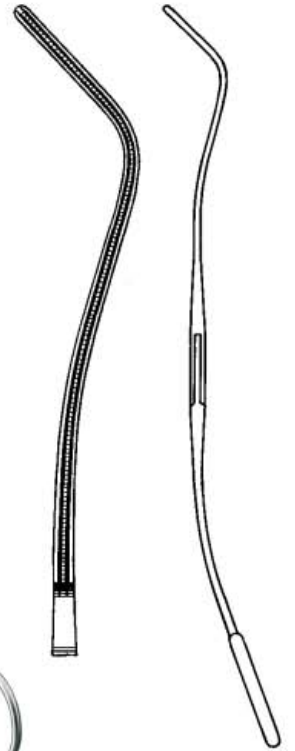

Leland-Jones

12-069
18 cm



12-070
19 cm



12-071
20 cm

MULTI PURPOSE VASCULAR CLAMPS



Bainbridge



12-072
15 cm



12-073
18.5 cm



Bainbridge



12-074
15 cm



12-075
18.5 cm



De Bakey



12-076
26 cm



12-077
27 cm



12-078
31 cm



12-079
33 cm



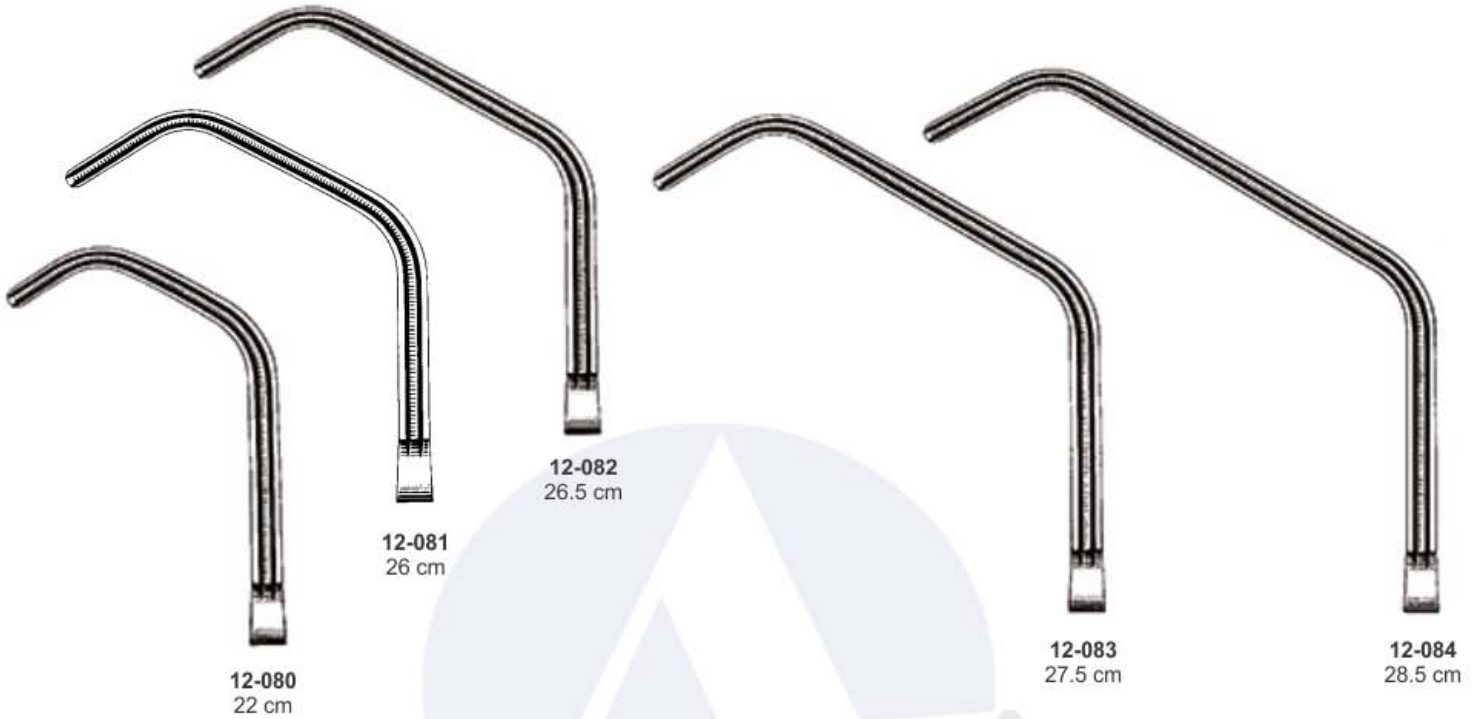

Aneurysm Clamps



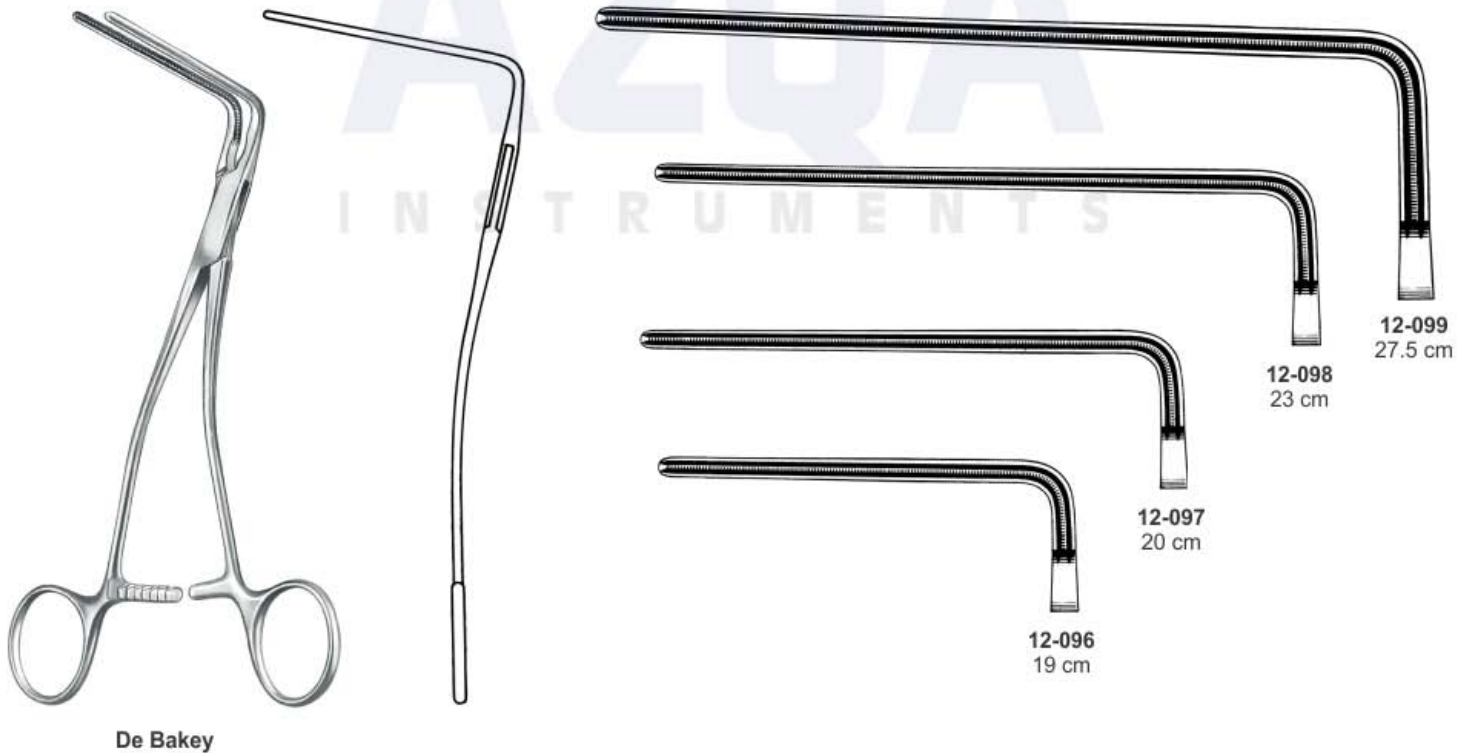



De Bakey



12-100
21 cm

12-101
22 cm

12-102
26 cm

12-103
31.5 cm



De Bakey
12-104
straight
17.5 cm



De Bakey



12-105
strongly
angled
15 cm



De Bakey Beck
12-106
17 cm

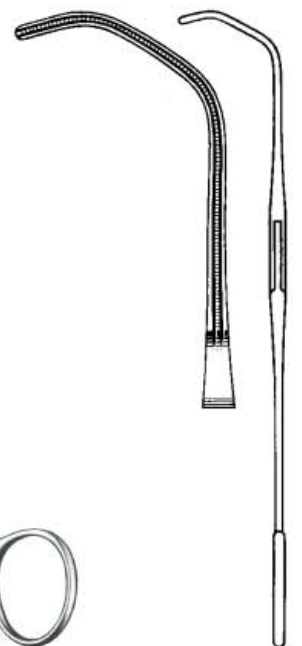

Anastomosis Clamps



Glover
12-107
curved
17 cm



Glover
12-108
spoon-shape
17.5 cm



De Bakey



12-110
16.5 cm

12-109
16.5 cm



Derra



12-111
16.5 cm



12-112
17 cm



12-113
17.5 cm

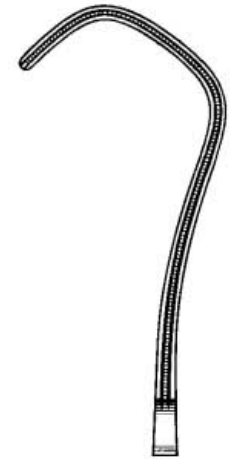



De Bakery

12-114
90° angled
10 cm

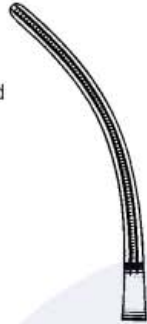

12-115
curved
13 cm



12-116
straight
13 cm



De Bakery

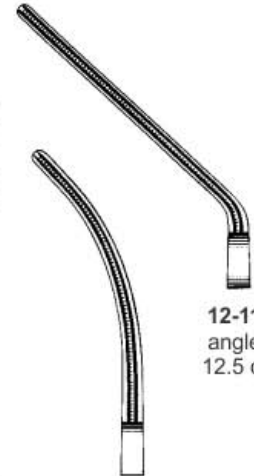

12-118
angled
12.5 cm

12-117
s-shape
12.5 cm

Anastomosis Clamps



Cooley

12-119
straight
14.5 cm



12-120
angled
14.5 cm



12-121
angled
14.5 cm



12-122
double curved
14 cm



12-123
spoon shape
14.5 cm



Cooley
12-124
angled
22 cm

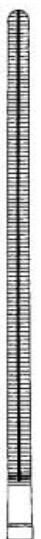

Neonatal Vascular Clamps



Castaneda Multipurpose Clamp & Atraumatic Cardiovascular Forceps

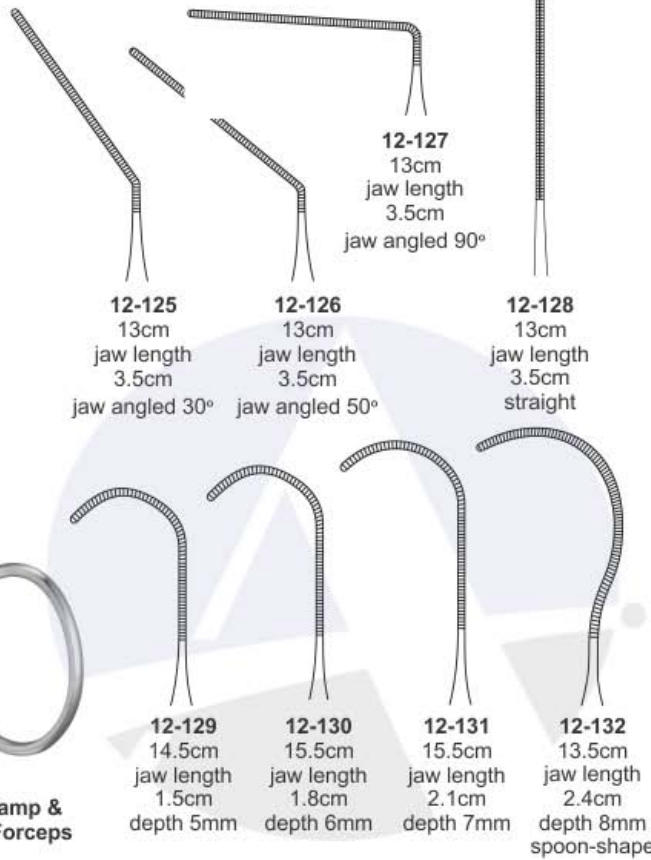

Cooley 12-133
curved sideways
17 cm



Cooley 12-134
double curved
16 cm



12-135
straight angled
14.5 cm



12-136
medium angled
16 cm



12-137
slight angled
16.5 cm



**Bailey-Gibbon
Rib Contractors
12-138
20 cm
For Adult**



**Bailey-Gibbon
Rib Contractors
12-139
20 cm
For children**



**Bailey-Baby
Rib Contractors
12-140
15 cm**



**Sellers Rib Contractor
12-141 20 cm**



**Blalock
Rib Contractors**

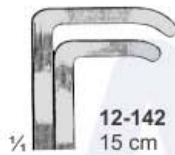

**12-142
15 cm**



**12-143
20 cm**

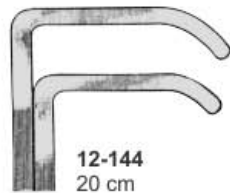

**12-144
20 cm**



**Johns-Hopkins
(Potts Modif.)
Rib Contractors**



**12-145
20 cm**



**12-146
20 cm**

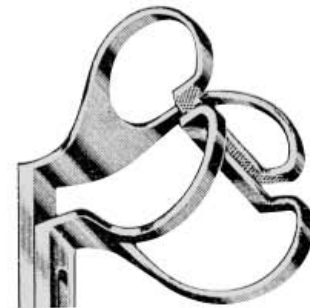

**12-147
20 cm**

Lungenspatel, Aorta-Dilatatoren

Spatules pulmonaires, Dilatateurs pour aorte

Espátulas pulmonares, Dilatadores aórticos

Spatole per pulmone, Dilatatori per aorta



Allison Lung Spatula Retractor
 12-148 25 cm
 12-149 30 cm
 12-150 32 cm
 wide 3.8cm
 Small Size



Allison Lung Spatula Retractor
 12-151 32.4 cm
 wide 5.2cm
 large size



Tubbs Mitral Valve Aortic Dilator
 12-152
 Blade Opening
 From 8 To 42 mm



Cooley Blade Aortic Dilator
 12-153
 Blade Opening
 From 8 To 15 mm



Morse 12-154
Sternal Retractor 4 movable
blades 22 x 27mm spreading 200 mm
Size 1,



DeBakey 12-155
Rib Retractor spreading 150 mm
Size 1,



DeBakey 12-156
Rib Retractor spreading 200 mm
Size 1,



Cherry 12-157
mm mm mm
44 70 135



Cooley Rib Retractors 12-158
lateral blades 12 x 16 mm spreading 95 mm



Cooley Rib Retractors 12-159 lateral blades 15 x 30 mm, spreading 140 mm
12-160 lateral blades 21 x 44 mm, spreading 150 mm

Rippensperrer

Ecarteur de côtes

Separador costal

Divaricatore costale



Cooley Rib Retractors

12-161

lateral blades 35 x 50 mm, spreading 200 mm

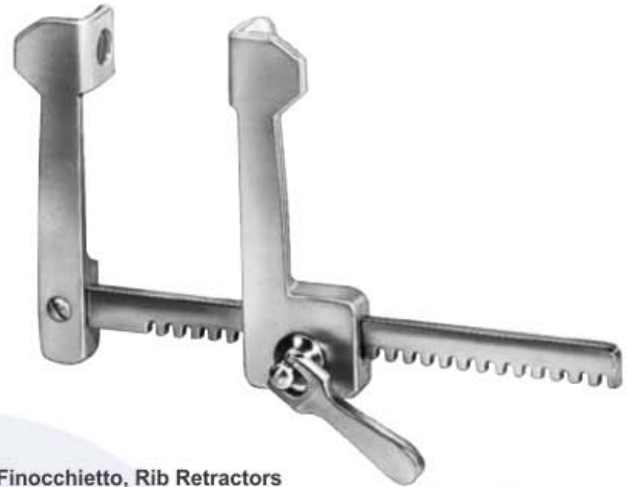

Finocchietto, Rib Retractors

12-162 lateral blades 15 x 15 mm, spreading 75 mm, infant

12-163 lateral blades 31 x 31 spreading 100 mm, baby - height

12-164 lateral blades 40 x 45 spreading 135 mm, baby - height

12-165 lateral blades 52 x 62 spreading 175 mm, baby - height

12-166 lateral blades 84 x 65 spreading 175 mm, baby - height



Haight Rib Retractor

12-167

lateral blades 30 x 30 mm, spreading 120 mm



Morse-Favaloro Sternal Retractor

12-168

4 movable blades 17 x 22 mm, spreading 160mm for children



Finocchietto (Modif.) Rib Retractors

12-169

lateral blades 14 x 15 mm, spreading 120 mm



Tuffier Rib Retractor

12-170

lateral blades 45 x 45 mm, spreading 160 mm

12-171

lateral blades 22 x 27 mm, spreading 200 mm

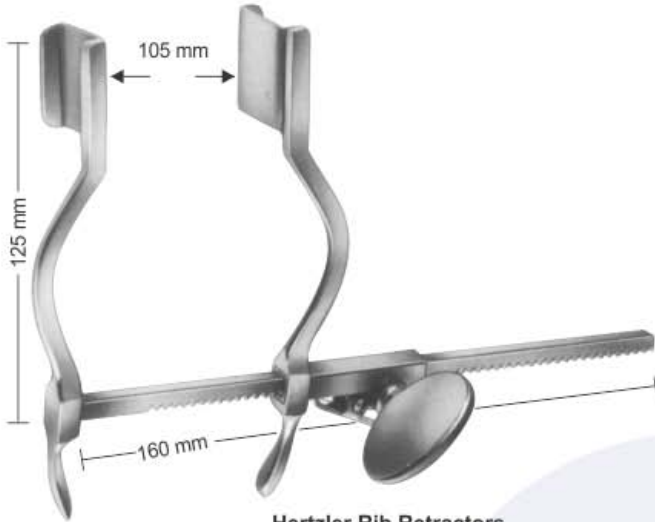

Hertzer Rib Retractors
12-172
blades 20 x 25 mm, spreading 105 mm

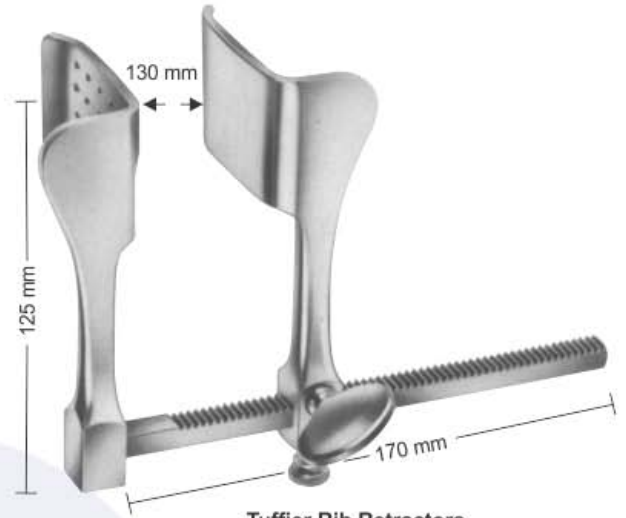

Tuffier Rib Retractors
12-173
blades 43 x 53 mm, spreading 130 mm



Thoracic Rib Retractors
12-174 Retractor only
12-175 pair of blades, 48 x 68 mm
12-176 1 pair of blades, 70 x 75 mm



Thoracic & I.M.A Rib Retractors
12-177 Complete set
12-178 lateral blades for I.M.A Retractor
left 40 x 50 x 80 mm
12-179 lateral blades for I.M.A Retractor
Right 40 x 50 x 80 mm

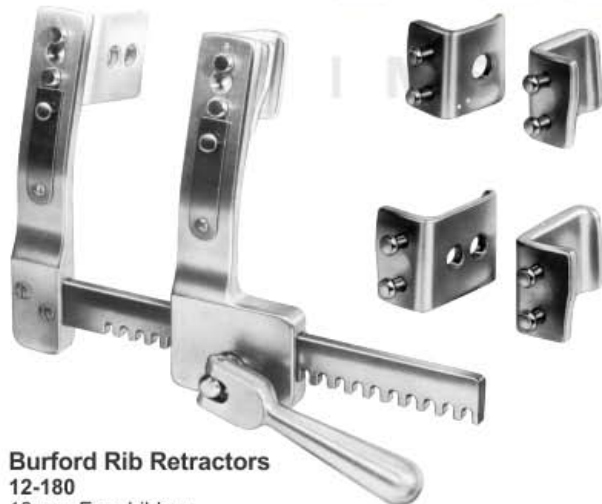

Burford Rib Retractors
12-180 18 cm For children
spread with 2 sets of Blades
12-181 48 mm x 42 mm spreading 135 mm
12-182 38 mm x 42 mm spreading 135 mm



Burford Rib Retractors
12-183 18 cm For Adults
spread with 2 sets of Blades
12-184 with two pair of blade 47 x 62 mm + 65 x 62 mm spreading 200 mm
12-185 with 2 pair of blade 47 x 62 mm + 65 x 62 mm spreading 260 mm
12-186 with 2 pair of blade 47 x 62 mm + 65 x 62 mm spreading 300 mm



Finocchietto/Baby Rib Retractors
12-187 7.5 cm
 14 mm x 15 mm spreading 75 mm



Finocchietto, Rib Retractors

- 20 cm
- 12-188** 30 mm x 45 mm spreading 150 mm
- 12-189** 46 mm x 62 mm spreading 190 mm
- 12-190** 80 mm x 65 mm spreading 190 mm



Castaneda Rib Retractors
12-191 10.5 mm x 32 mm
 spreading 65 mm



Castaneda Rib Retractors
12-192 12 mm x 45 mm
 spreading 70 mm



Castaneda Rib Retractors
12-193 15 mm x 60 mm
 spreading 120 mm

Rippenscheren, Sternummeißel
Costotomos, Cinceles

Costotomes, ciseau-Burin à sternum
Costotomi, Scalpello per sterno



Sauerbruch-Frey Rib Shears
12-194
for the first rib
37 cm



Schumacher Rib Shears
12-195
sternum shears
21 cm



Bone Rib Shear
12-196
23 cm



Rib Shear
12-197
23 cm



Gluck Rib Shear
12-198
22 cm



Lebsche Sternum Chisel
12-199 24.5 cm



Semb Rib Shears
12-200 20 cm



Semb Rib Shears
12-201 20 cm

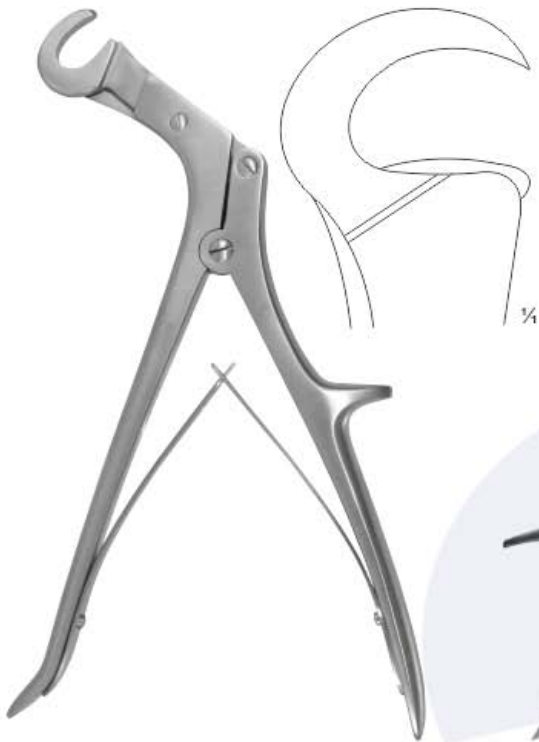

Giertz-Stille Rib Shears
12-202 27 cm

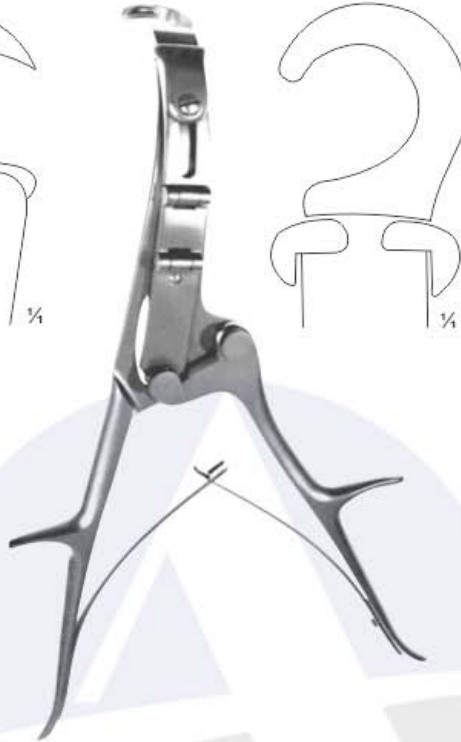

Brunner Rib Shears
12-203 33.5 cm



Maurer-Collin Rib Shears



12-204
Hooked Left
23 cm



12-205
Hooked Right
23 cm



Sauerbruch Rib Shears
12-206 24 cm, For Children
12-207 27 cm, For Adults



Schuardt Rib Shears
12-208 17 cm



Collin Rib Shears
12-209 19 cm



Doyen Rib Shears
12-210 19 cm

OPHTHALMIC INSTRUMENTS



Micro Forceps



Chalazion Clamp
13-001
11cm



Chalazion Forceps
13-002
Oval 12 X 14mm, 10 cm long



13-003
Round 8mm,
10 cm long



13-004
Round 15mm,
10 cm long



13-005
Oval 17 X 9mm,
10 cm long



Chalazion Forceps
13-006



Cauer
13-007
10 cm
Chalazion Forceps



Suture Tying Forceps
13-008 9cm
13-009 11cm



McPherson Forceps
13-010 9cm
13-011 11cm



Corneal Forceps
1x2 (0.12)
13-012 9cm
13-013 11cm



Bonn Forceps
13-014
11cm



Utrata
Capsulorhexis
Forceps
13-015 11cm
Curved



Utrata
Capsulorhexis
Forceps
13-016 11cm
Straight



Colibri Forceps
1x2 (0.12)
13-017



Holding & Folding
Forceps
for Acrylic Lenses
13-018
11cm



Holding & Folding
Forceps
for Acrylic Lenses
13-019
11cm



Morefeldt Forceps
13-020
11cm

Round Handle Available



Suture Tying Forceps
13-021 9cm
13-022 11cm

Round Handle Available



McPherson Forceps
13-023 9cm
13-024 11cm



Corneal Forceps
 1x2 (0.12)
13-025 9cm
13-026 11cm



Bonn Forceps
13-027 9cm
13-028 11cm



Utrata Capsulorhexis Forceps
13-029 9cm
13-030 11cm
 Curved



Utrata Capsulorhexis Forceps
13-031 9cm
13-032 11cm
 Straight



Holding & Folding Forceps for Acrylic Lenses
13-033 9cm
13-034 11cm



Holding & Folding Forceps for Acrylic Lenses
13-035 9cm
13-036 11cm



Colibri Forceps
 with tying platform
13-037



Gerl Tying Forceps
 curved shanks
 6mm long platform
 For 8-0 to 11-0 sutures.
 titanium
13-038



Tennant Tying Forceps
 extra delicate smooth jaws
 with 6mm long platform
 round handle with guide pin
 For 9-0 to 11-0 sutures.
13-039 straight
13-040 straight, titanium
13-041 curved
13-042 curved, titanium



Self-Retaining Retractors

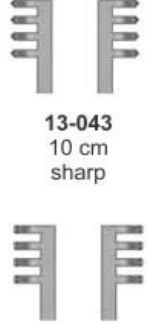

13-043
 10 cm
 sharp

13-044
 10 cm
 blunt



Berke Ptosis Forceps
13-045
 11 cm



Förster Conjunctiva Forceps
13-046
 10 cm



Fechtner Conjunctiva Forceps
13-047 11 cm long
 Very delicate ring tips,
 with tying platforms



Scleral Plug Forceps
13-048
 Designed to securely hold scleral plugs during insertion and removal. The cross-action handle reduces hand fatigue while grasping plug, 11.5 cm long

Round Handle Available



McPherson
Forceps
13-049



13-050



Suture Tying
Forceps
13-051



13-052



Utrata Capsulorhexis
Forceps
13-053



13-054



Corneal Forceps
1x2 (0.12)
13-055



13-056



Colibri
Forceps
extra delicate
1x2 teeth, 0.12mm
with tying platform
13-057



13-058
Cooley
18 cm



13-059
Castroviejo TC
18cm



13-060
Noyes Micro Scissors
CVD 18cm



Needle Holder
delicate, curved, without lock,
overall length: 115mm, titanium
Ideal for 9-0 to 10-0 sutures
13-061 with lock
13-062 without lock
13-063 titanium, with lock
13-064 titanium, without lock



Barraquer
Needle Holder
delicate jaws, straight
13-065 with lock
13-066 without lock
13-067 titanium, with lock
13-068 titanium, without lock

Micro Scissors



IOL Holding Forceps
13-069 11.5cm



Micro Needle Holders
13-070 11.5cm



Corneal Scissors
13-071 11.5cm



Cepulotomy Scissors
13-072 11.5cm



Vannas Scissors
13-073 11.5cm
Straight



Vannas Scissors
13-074 11.5cm
Curved



Westcott Scissors
13-075 11.5cm



Iris Scissors
13-076 11.5cm



Vannas Scissors
13-077

Sharp pointed tips. Curved 7.5mm blades, 9.5mm from pivot to tip, 8 cm long



Vannas Scissors
13-078

Sharp tips. Angled to side 7mm blades, 9mm from pivot to tip, 8 cm long



13-079



13-080



13-081



13-082



13-083



13-084



13-085

Capsulotomy Scissors Vannas

5mm long blades, sharp tips

13-079 straight

13-080 curved

13-081 angled forward

13-082 angled to side

Gills-Vannas

7mm long blades, sharp tips

13-083 straight

13-084 curved

13-085 angled forward

Mcpherson-Vannas

8mm long blades, sharp tips

13-086 curved



Barraquer
Needle Holder
delicate jaws, curved
13-087 with lock
13-088 without lock



McPherson
Needle Holder
very delicate jaws
13-089 with lock straight
13-090 without lock straight
13-091 with lock curved
13-092 without lock curved



Micro Needle Holder
Needle Holder
delicate jaws
strongly curved
13-093 with lock
13-094 without lock



Castroviejo
Needle Holder
delicate jaws, curved
13-095 with lock
13-096 without lock



Castroviejo
Needle Holder
standard jaws
straight, with lock
13-097
13-098 TC Tungsten Tip



Kalt
Needle Holder
delicate smooth jaws
straight, with lock
13-099



Micro Incision Forceps
13-100



Micro Incision Scissors
13-101



Endothelial Grasping Forceps
13-102
curved, 23 gauge
delicate end-gripping
platforms jaws 90°
off-set from "squeeze handle"
mechanism



Vitreoretinal Forceps
Lens Cartridge
Loading Forceps
straight, 20 gauge
13-103



Vitreotomy Scissors
T20 gauge shank
Stainless steel
construction with
flat handle.
Autoclavable.



Scissors
horizontal opening
straight
13-104



Scissors
horizontal opening
angled 60°
13-106



Scissors
horizontal opening
angled 30°
13-105



Scissors
horizontal opening
angled 80°
13-107



Troutman-Castroviejo
delicate patterns, with stop



13-108
10,5 cm
right



13-109
10,5 cm
left



Wecker
13-110
11 cm
pointed-pointed

11 mm

Cannulas



Sterilizing Boxes (with silicon Pads)

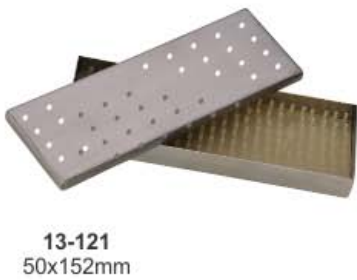



Curette
13-124



Wire Vectus
13-125



Strabismus Hook
13-126



Lense Expressor
13-127



Bimanual Hand Irrigation
13-128



Bimanual Hand Aspiration
13-129



Rosen
Phco Splitter
60° angled wedge
shaped inferior edge
with blunt tip
13-130
Titanium



Nagahara
Chopper
13-131



Sinskey
Hook
13-132



Sinskey
Hook
13-133



Nagahara
Chopper
13-134



Lachrymal Dilator
Double Ended
13-135



Lachrymal Dilator
13-136 Fine Taper
13-137 Medium Taper
13-138 Heavy Taper



Lachrymal Probes
13-139



Sinskeyll
 Lens Manipulating Hook
 0.2mm diameter blunt tip
 13-140 straight
 13-141 angled



Lens Manipulating Hook
 0.15mm diameter tip
 13-142
 Fenzl, round handle
 straight with guard
 13-143
 Fenzl, round handle, angled
 13-144
 Maltzman-Fenzl, round handle,
 13-145
 Maltzman-Fenzl, round handle,
 angled
 13-146
 Jaffe-Maltzman, flat handle, angled



Fixation Hook
 double, sharp
 13-147
 15 cm
 13-148
 18 cm



VON GRAEFE Knife
 Graefe
 1,2,3,4,5,

KNIVES



Jaeger Lid Plate
 13-155
 Jaeger
 4", 20mm, 23mm,

Eye Knives

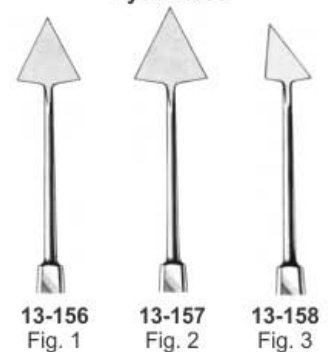

Jaeger



Barraquer Wire Speculums
13-159
heavy wire, 15mm blades



Barraquer Solid Blade
Wire Speculum
13-160
Barraquer, 10mm blades



Kratz - Barraquer
Wire Speculum
15mm blades
one solid and one open wire
13-161
for right eye



Kratz - Barraquer
Wire Speculum
15mm blades
one solid and one open wire
13-162
left eye



Wire
Speculums
13-163



Wire
Speculums
13-164



Laster-Burch Speculum
eye Speculum with flanges on
blades for retaining eye lashes
adjustable mechanism
with locking screw
13-165
11mm blades



Lieberman
Speculum
13-166



Clark
Speculums
13-167



Jameson
Caliper chrome
plated
13-168



Braunstein Caliper
3.5/4.0mm
Stainless Steel
13-169



13-170
Calliper
Fixed



Fixed
Caliper
13-171



Castroviejo Caliper
20mm spread
13-172 straight
13-173 angled
13-174 curved



Maloney
Intra-Operative
Keratometer titanium
For qualitative
measurement
of astigmatism.
13-175

ENT SURGERY





14-001
4.5 mm Ø



14-002
5.5 mm Ø



14-003
6.5 mm Ø



14-004
7.5 mm Ø



14-007
2 mm Ø



14-008
3 mm Ø



14-009
4 mm Ø



14-010
5 mm Ø



Toynbee Ear Speculum
3.6 cm 1 1/2"
Set for adults

14-005
Set of 3
5.5 mm
6.5 mm
7.5 mm

14-006
Set of 4
4.5 mm
5.5 mm
6.5 mm
7.5 mm



Poltzer Ear Speculum
Set for adults

14-011
Set of 3
2 mm
3 mm
4 mm

14-012
Set of 4
2 mm
3 mm
4 mm
5 mm



Gruber Ear Speculum
Set for adults



14-013
a - 4.5 mm Ø



14-014
a - 5.5 mm Ø



14-015
a - 6.5 mm Ø



14-016
a - 7.5 mm Ø



14-017
a - 4.5 mm Ø



14-018
a - 5.5 mm Ø



14-019
a - 6.5 mm Ø



14-020
a - 7.5 mm Ø



Gruber Ear Speculum
Set for adults

I N S T R U M E N T S



14-021
4.5 mm Ø



14-022
5.5 mm Ø



14-023
6.5 mm Ø



14-024
7.5 mm Ø



14-025
3 mm Ø



14-026
4.5 mm Ø



14-027
5.5 mm Ø



Boucheron Ear Speculum
Set for adults



Boucheron Ear Speculum
Set for children

Ohrspekulum

Espéculo de oreja

Spéculum auriculaire

Speculum auricolare

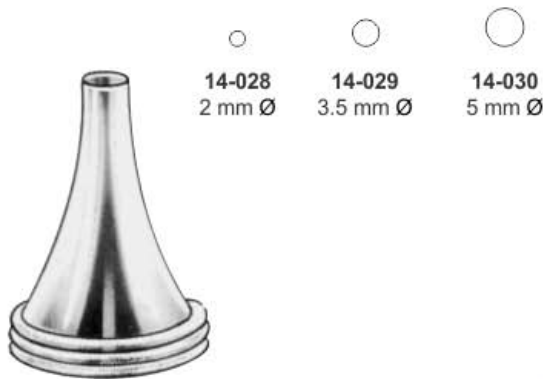

- **14-028**
2 mm Ø
- **14-029**
3.5 mm Ø
- **14-030**
5 mm Ø

Hartmann Ear Speculum
for children



- **14-031**
4.5 mm Ø
- **14-032**
5.5 mm Ø
- **14-033**
6.5 mm Ø
- **14-034**
7.5 mm Ø

Hartmann Ear Speculum
Set for adults



- **14-035**
4.5 mm X 6.5 mm
- **14-036**
6.5 mm X 7.5 mm
- **14-037**
7.5 mm X 8.5 mm
- **14-038**
8.5 mm X 9.5 mm
- **14-039**
9.5 mm X 10.5 mm
- **14-040**
10.5 mm X 11.5 mm

Zollner Ear Speculum
Set for adults, Black



- **14-041**
2 mm
- **14-042**
3.5 mm
- **14-043**
5 mm
- **14-044**
6.5 mm
- **14-045**
7.5 mm

Hartmann Ear Speculum
Set for adults, Black



Gruber Aural Specula Ear Speculum

- Black finish, 38 mm Ø
- 14-046** Set of 4
 - 14-047** 3 mm
 - 14-048** 4 mm
 - 14-049** 5 mm
 - 14-050** 7 mm



Rosen Ear Speculum

- Black finish, Slotted round ends 35 mm Ø
- 14-051** Set of 4
 - 14-052** 3 mm
 - 14-053** 4 mm
 - 14-054** 5 mm
 - 14-055** 7 mm



Rosen Ear Speculum

- slotted round ends
Black finish, 35 mm Ø
- 14-056** Set of 4
 - 14-057** 4 mm
 - 14-058** 5 mm
 - 14-059** 6 mm
 - 14-060** 7 mm



Tumarkin Ear Speculum

- Tapered slot set of 8
- 14-061** 4.5 mm
 - 14-062** 6.5 mm
 - 14-063** 7.0 mm
 - 14-064** 7.5 mm
 - 14-065** 8.0 mm
 - 14-066** 8.5 mm
 - 14-067** 9.0 mm
 - 14-068** 11 mm



14-069
6.5 mm Ø



14-070
7 mm Ø



14-071
8 mm Ø

Siegle Magnifier Ear Speculum
14-072
Complete Set
with 3 Ear Specula & Otoscope



Bruenings
complete
14-073

Bruenings Ear Speculum
Complete Set
with 4 Ear Specula & Otoscope



Siegle Magnifier
Otoscope



14-074
6.5 mm Ø



14-075
7.5 mm Ø



14-076
8.5 mm Ø



14-077
9.5 mm Ø



Bruening Magnifier
Otoscope



**Richnau Holmgren
Ear Speculum**
3.5 cm

- 14-078
3 mm Ø
- 14-079
4 mm Ø
- 14-080
5 mm Ø
- 14-081
6 mm Ø



Vacher Nasal Speculum
14-082

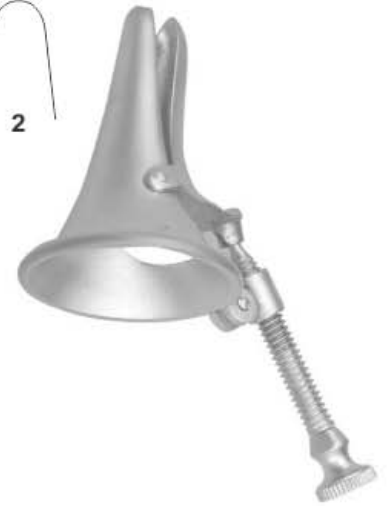
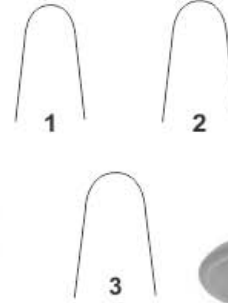

Votolini Nasal Speculum
14-083 Fig. 1
14-084 Fig. 2
14-085 Fig. 3



Yankauer
14-086
19cm

- 14-087
2 mm Ø
- 14-088
2,5 mm Ø
- 14-089
3 mm Ø
- 14-090
4 mm Ø
- 14-091
5 mm Ø



Hartmann
Eustachian Catheters



Reiner Ear syringe
14-092
50CC Complete
14-093
75CC Complete



**Reiner Ear
Syringe
Tip Only**
14-096
Tip Only



**Reiner Ear
Syringe
Tip Only**
14-097
Tip Only



**Reiner Ear
Syringe Shield**
14-098

14-094
100CC Complete
14-095
150CC Complete
Reiner Ear syringe
With Tip & Shield



**Hartmann
Tuning Fork
14-099**
C 64

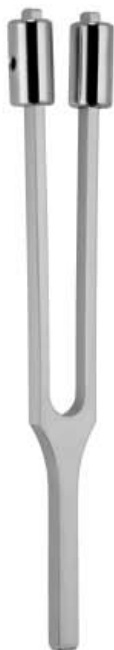

**Hartmann
Tuning Fork
14-100**
c 128



**Hartmann
Tuning Fork
14-101**
c1 256



**Hartmann tuning
fork with or without
plastic base a1 440**
14-102
a1 440



**Tuning Forks neuro
with hammer**
14-103



Barany Noise Drum
14-104

NOISE DRUM

Lärmtrommel	Aparato
Assourdisseur	Assordatore



**Lucae
Tuning Fork
14-105**
c 128
Variable up to h (ehn, b)



**Rydel-Seiffer
Tuning Fork
14-106**
C 64 / c 128
With clamps C 64,
Without clamps c 128



**French
Tuning Fork
14-107**
C2 16



**French
Tuning Fork
14-108**
C1 32



14-115
Hartmann tuning Forks Set case/5



14-121
TUNING FORKS Set in case of 5

14-116
c 128

14-117
c1 256

14-118
c2 512

14-119
c3 1024

14-120
c4 2048

Ohrpolypenschnürer

Polipótomos auriculares

Serre noeuds auriculaires

Serranodi auricolari



Nasal Polypus Snares
14-122
0.3 mm Ø X 100 mm
In bundles of 12 pieces



Krause Nasal Polypous Snares
14-123
25.4 cm



Kraus -Vosse Nasal Polypous Snares
14-124
25.4 cm
With 2 inserts



Kraus -Wilde Nasal Polypous Snares
14-125
24 cm



Krause
14-126
26 cm



EVE Tonsil Snare
28 cm
14-127 without ratchet
14-128 with ratchet



Eves Tonsil Snare

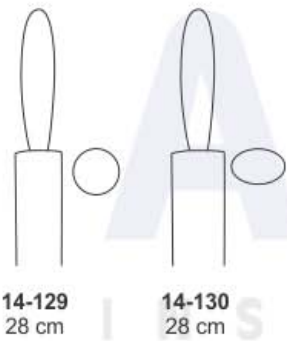

14-129
28 cm

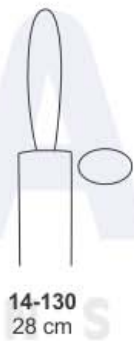

14-130
28 cm



Eves Tonsil Snare



14-131
28 cm



Bruenings Tonsil Snare

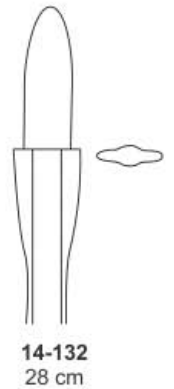

14-132
28 cm



Bruenings
14-133
10 m 33 ft
0.3 mm Ø
14-134
10 m 33 ft
0.4 mm Ø



Bruenings
14-135
40 mm
Package of 100 pieces
14-136
50 mm
Package of 100 pieces



Tyding Tonsil Snare
14-137
With one straight tip

NASAL SPECULUM

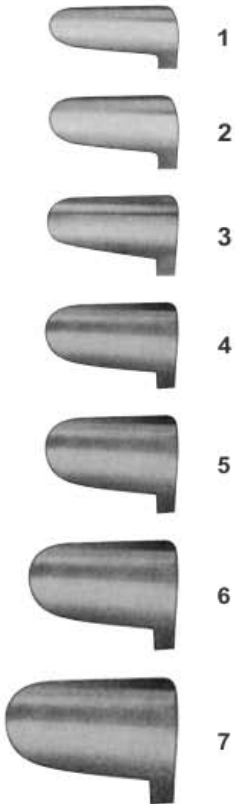

Thudichum (Goldsmith) Nasal Speculum
6.5cm
14-138 Fig. 1
14-139 Fig. 2
14-140 Fig. 3
14-141 Fig. 4
14-142 Fig. 5
14-143 Fig. 6
14-144 Fig. 7

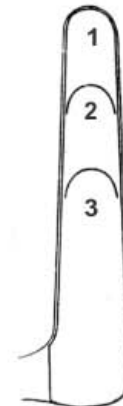

ST-CLAIR THOMSON
14-145 Fig 1
14-146 Fig 2
14-147 Fig 3

Nasenspekulum
Spéculum nasal

Espéculo nasal
Speculum nasale



**Thudichum
(Goldsmith)
Nasal Speculum**



14-148
6.5 cm
21 mm X 9.5 mm



14-149
6.5 cm
21 mm X 10.5 mm

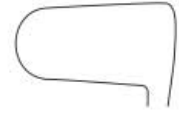

14-150
6.5 cm
21 mm X 11.5 mm



**Hartmann
Nasal Speculum**



14-151
16 cm
Tip Size
27mm



14-152
16 cm
Tip Size
31mm

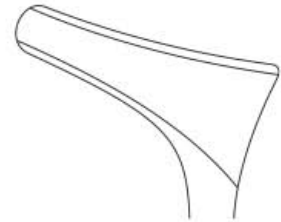

14-153
16 cm
Tip Size
35mm



**Hartmann-Halle
Nasal Speculum**



14-154
15 cm



14-155
15 cm



14-156
15 cm

Nasenspekulum
Spéculum nasal

Espéculo nasal
Speculum nasale



**Tieck-Halle
Nasal Speculum**



14-157
13.5 cm
For babies



Schwarz Nasal Speculum

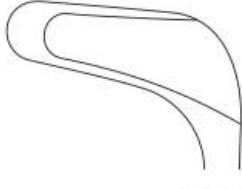

14-158
14 cm



Vienna Speculum
14-159 13cm
14-160 14.6cm
medium standard patter



14-161
Nose Speculum,
thigh 30mm



Killian Nasal Speculum



14-162
13 cm
X = 35 mm

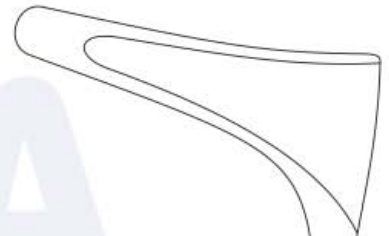

14-163
13 cm
X = 50 mm

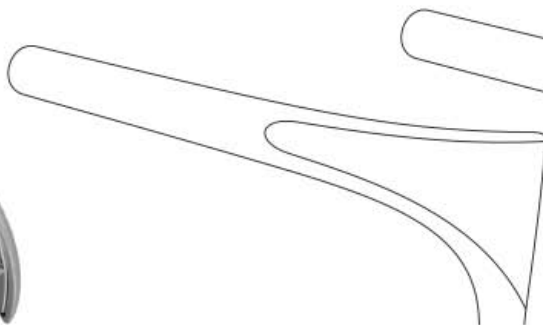

14-164
13 cm
X = 75 mm

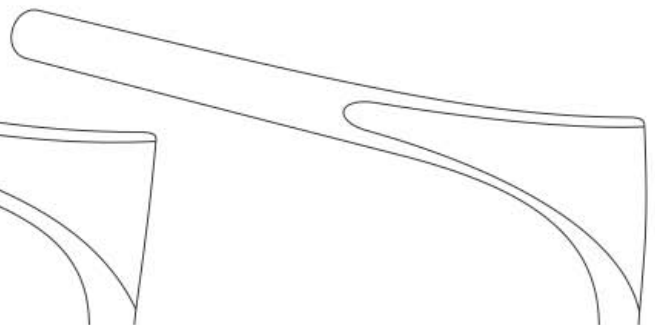

14-165
13 cm
X = 90 mm

Nasenspekulum
Spéculum nasal

Espéculo nasal
Speculum nasale



Killian Septum Speculum
14-166
15 cm
2.51 cm blades
with set screw



Killian Septum Speculum
14-167
15 cm
8.9cm blades
set screw



Killian Septum Speculum
14-168
Fiber Optic 15 cm
length 2.51mm deep



Beckmann
Nasal Speculum



14-169
15 cm
25mm



14-170
15 cm
28mm

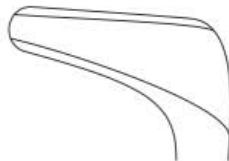

14-171
15 cm
32mm



Mod. Wien
Nasal Speculum



14-172
14.5 cm
25cm

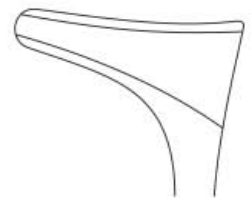

14-173
14.5 cm
27cm

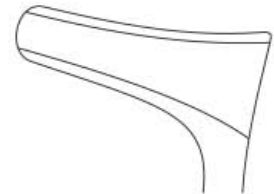

14-174
14.5 cm
30cm

Nasenspekulum
Spéculum nasal

Espéculo nasal
Speculum nasale



Cottle Nasal Speculum

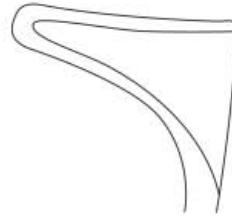

14-175
15 cm
X = 35 mm

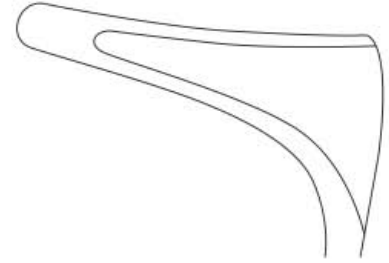

14-176
15 cm
X = 50 mm

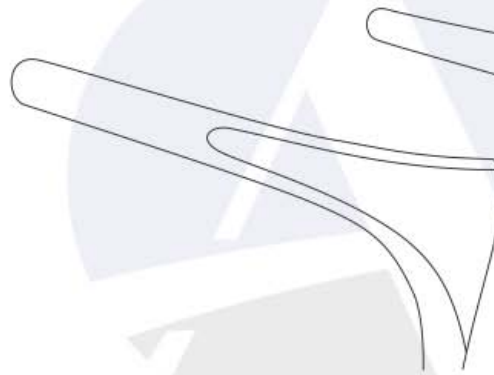

14-177
15 cm
X = 75 mm

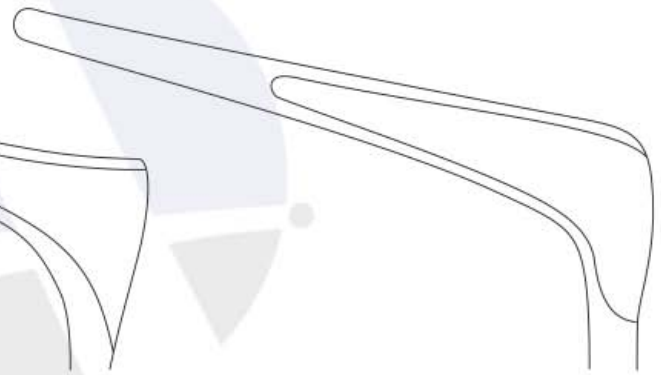

14-178
15 cm
X = 90 mm



Cottle Nasal Speculum



14-179
14 cm
X = 45 mm



14-180
14 cm
X = 75 mm

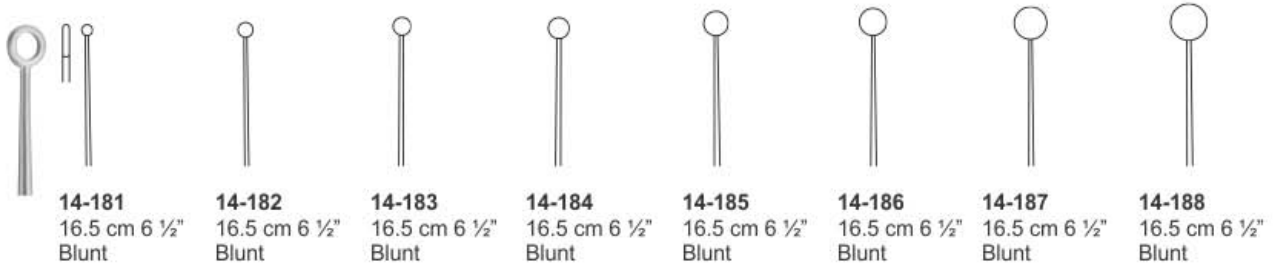

14-181 16.5 cm 6 1/2" Blunt	14-182 16.5 cm 6 1/2" Blunt	14-183 16.5 cm 6 1/2" Blunt	14-184 16.5 cm 6 1/2" Blunt	14-185 16.5 cm 6 1/2" Blunt	14-186 16.5 cm 6 1/2" Blunt	14-187 16.5 cm 6 1/2" Blunt	14-188 16.5 cm 6 1/2" Blunt
--	--	--	--	--	--	--	--



14-189 16.5 cm 6 1/2" Sharp	14-190 16.5 cm 6 1/2" Sharp	14-191 16.5 cm 6 1/2" Sharp	14-192 16.5 cm 6 1/2" Sharp	14-193 16.5 cm 6 1/2" Sharp	14-194 16.5 cm 6 1/2" Sharp	14-195 16.5 cm 6 1/2" Sharp	14-196 16.5 cm 6 1/2" Sharp
--	--	--	--	--	--	--	--

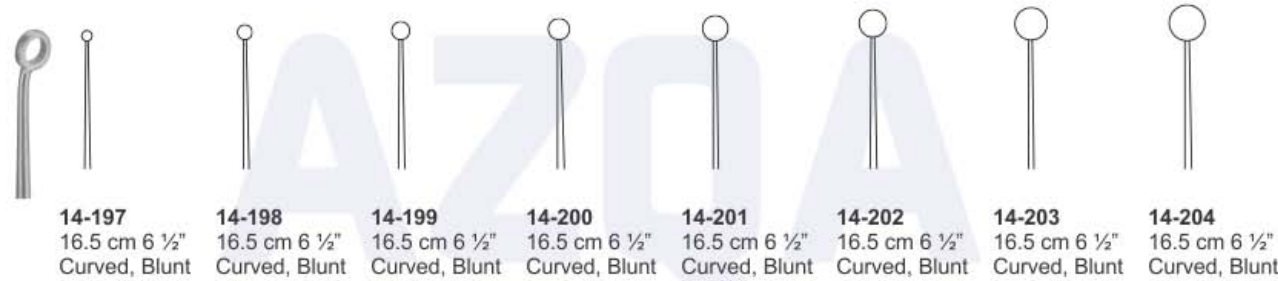

14-197 16.5 cm 6 1/2" Curved, Blunt	14-198 16.5 cm 6 1/2" Curved, Blunt	14-199 16.5 cm 6 1/2" Curved, Blunt	14-200 16.5 cm 6 1/2" Curved, Blunt	14-201 16.5 cm 6 1/2" Curved, Blunt	14-202 16.5 cm 6 1/2" Curved, Blunt	14-203 16.5 cm 6 1/2" Curved, Blunt	14-204 16.5 cm 6 1/2" Curved, Blunt
--	--	--	--	--	--	--	--

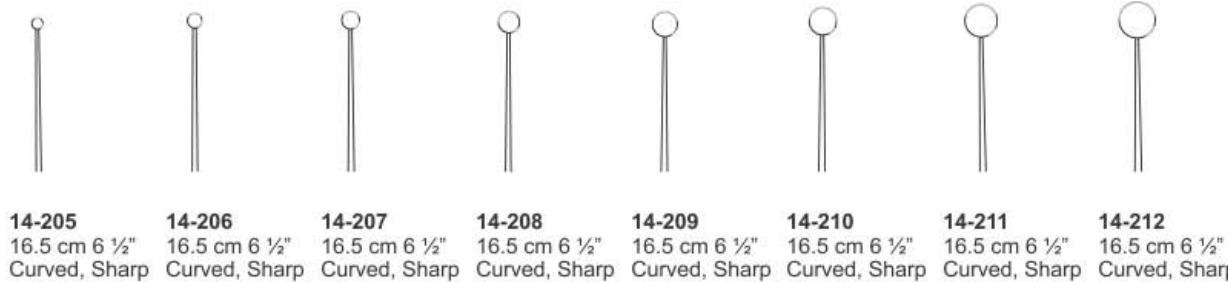

14-205 16.5 cm 6 1/2" Curved, Sharp	14-206 16.5 cm 6 1/2" Curved, Sharp	14-207 16.5 cm 6 1/2" Curved, Sharp	14-208 16.5 cm 6 1/2" Curved, Sharp	14-209 16.5 cm 6 1/2" Curved, Sharp	14-210 16.5 cm 6 1/2" Curved, Sharp	14-211 16.5 cm 6 1/2" Curved, Sharp	14-212 16.5 cm 6 1/2" Curved, Sharp
--	--	--	--	--	--	--	--



Buck, Ear Curette

I N S T R U M E N T S



Ohrküretten und scharfe Löffel

Curetas y cucharillas auriculares cortantes

Curettes auriculaires et cuillères tranchantes

Curette auricolari e cucchiari taglienti



Farrell Applicator
14-213
16.5 cm 6 1/2"
cross-serrated tip

Langenbeck Ear Curette
14-214
13 cm
Blunt

Jansen Ear Curette
14-215 15 cm
14-216 16 cm
14-217 17 cm
Sharp

Gross Ear Spoon
14-218 12 cm
Sharp, Not fenestrated

Gross Ear Curette
14-219 12 cm
Blunt, fenestrated

Gansen Ear Curette
14-220 16 cm
Sharp

Billeau Ear Loop

14-221
16.5 cm

14-222
16.5 cm

14-223
16.5 cm

EAR LOOPS - HOOKS

TONSIL KNIVES



Lucae Hooklet

Wagener Hooklet Buttoned

Freer Tonsil Knife
14-234
21 cm 8 1/4"

Freer Tonsil Knife
14-235
21 cm 8 1/4"

Tonsil Knife
14-236
20 cm 8"
Sharp

Tonsil Knife
14-237
20 cm 8"
Sickle knife



**Bruenings
Tonsil Knife**
14-238
23 cm 9"



**Abraham
Tonsil Knife**
14-239
22 cm 8 3/4"



**Fischer Tonsil
Knife and Dissector**
14-240
21.6 cm 8 1/2"
semi-sharp tip, with teeth



**Fomon
Nasal Knife**
14-241
16.5 cm



**14-242
Fig.1**
16.5 cm
S/S Str.

**14-244
Fig.1**
16.5 cm
S/S Cvd.



**14-243
Fig.2**
16.5 cm
S/S Str.



**14-245
Fig.2**
16.5 cm
S/S Cvd.



**Joseph
Nasal Knife**
14-246
14 cm



**Cottle
Nasal Knife**
14-247
15 cm



**Joseph
Nasal Knife**
14-248
17.5 cm



**Converse
Nasal Knife**
14-249
16 cm



**Freer
Nasal Knife**
14-250
15 cm



**Freer
Nasal Knife**
14-251
15 cm



**Freer
Nasal Knife**
14-252
15 cm



**Freer
Nasal Knife**
14-253
19 cm



**Freer
Nasal Knife**
14-254
19 cm



**Bruenings
Septatome**
14-255
16.5 cm
14-256
Bruenings
Spare blade



**Coakley
Antrum Curette**
14-257
21 cm



14-258
20 cm

14-259
20 cm

Antrum Curette



Antrum Curette
14-260
20 cm
7 mm X 11 mm



**Pratt Antrum
Curette**
14-261
21 cm



**Faulkner
Antrum Curette**
14-262
21 cm



**Coakley
Antrum Curette**



14-263
17 cm



14-264
17 cm



14-265
17 cm



14-266
17 cm



14-267
17 cm



14-268
17 cm

Antrum Curette
14-269
17 cm
Complete set



**Hypophyseal
Curette** 14-270
19cm



**Hypophyseal
Curette** 14-271
19cm

Septum elevatorien - Raspatorien
Elevadores - legras para el tabique nasal
Elevateurs - rugines pour la cloison nasale
Elevatori - periostotomi per setto

**Lempert
Septum
Elevators
Raspatory
14-272**
20.5 cm 8"
X = 6 mm



**Lempert
Septum
Elevators
Raspatory
14-273**
18 cm 7"
X = 6 mm



**Cottle
Septum
Elevators
Raspatory
14-274**
19 cm 7 1/2"
X = 8 mm
Sharp



**Joseph
Septum
Elevators
Raspatory
14-275**
16 cm 6 1/4"
X = 5 mm
Periosteal elevators



**Joseph-Masing
Septum Elevators
Raspatory
14-276**
21.5 cm 8 1/2"
Sharp



**Pennington
Septum
Elevators
Raspatory
14-277**
21.5 cm 8 1/2"
Blunt



**Freer
Septum
Elevators
Raspatory
14-278**
19 cm 7 1/2"
Blunt



**Freer
Septum
Elevators
Raspatory
14-279**
18 cm 7"
Sharp/Blunt



**Freer
Septum
Elevators
Raspatory
14-280**
20.5 cm 8"
Sharp/Blunt



**Cottle
Septum
Elevators
Raspatory
14-281**
23.5 cm 9 1/4"
X = 5 mm
Sharp

Periostelevatorien, Septumelevatorien

Legras para periostio, Elevadores para el tabique nasal

Elevateurs pour la périoste, Elevateurs pour la cloison nasale

Elevatori per il periostio, Elevatori per setto



Masing Periosteal Septum Elevators
14-282 20 cm 8"

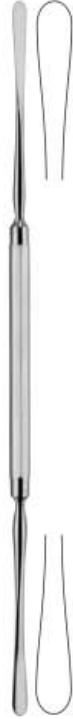

Ballenger-Hajek Periosteal Septum Elevators
14-283 19 cm 7 1/4"
14-284 22 cm 8 3/4"



Cottle Periosteal Septum Elevators
14-285 22 cm 8 3/4"



Cottle Periosteal Septum Elevators
14-286 21 cm 8 1/4"



Watson-Cheyne
13 cm 5" Raspatory

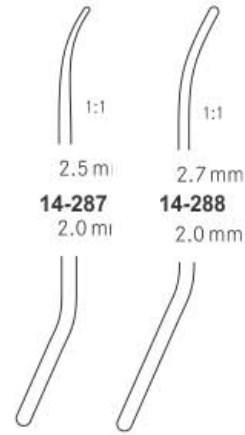

Boies
14-289 19 cm 7 1/2"
Nasal fracture elevator, Blunt



Goldman
14-290 17 cm 6 3/4"
Sptum displacer



Henke Tonsil Dissector
14-291 23 cm



Henke Tonsil Dissector
14-292 23 cm



Hurd Tonsil Dissector
14-293 22 cm

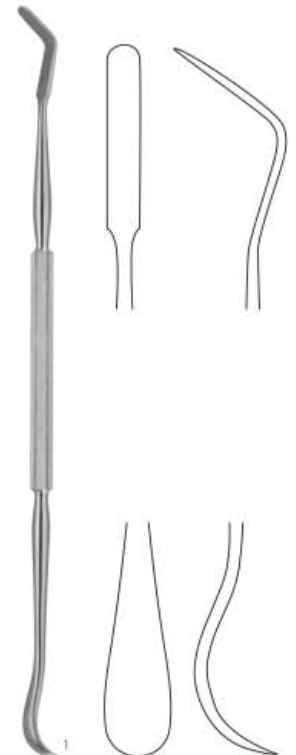

Carpenter Enucleator
14-294 25 cm



**Luniatschek
Tonsil
Tampon
Plugger
14-295
19 cm**



**Lewis
Tonsil
Screw
14-296
19.5 cm**



**Joseph
Nasal
Saw
14-297
19 cm 7 1/2"**



**Joseph
Nasal
Saw
14-298
19 cm 7 1/2"**



**Joseph
Nasal
Saw
14-299
19 cm 7 1/2"**

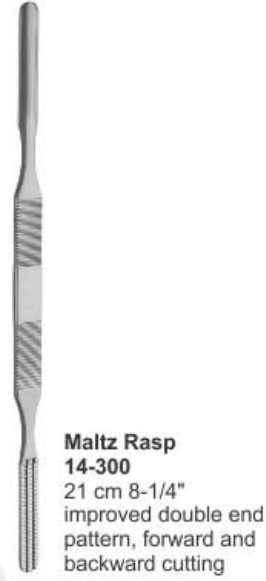

**Maltz Rasp
14-300
21 cm 8-1/4"
improved double end
pattern, forward and
backward cutting**



**Joseph
Rasp
14-301
15.9 cm
fine cross
serrations**



**Joseph Nasal Saw
14-302
17 cm 6 3/4"**

**Joseph Nasal Saw
14-303
17 cm 6 3/4"**

RASPS WITH TUNGSTEN CARBIDE



**Fomon Rasp
with Tungsten
Carbide TC
20cm 8"**

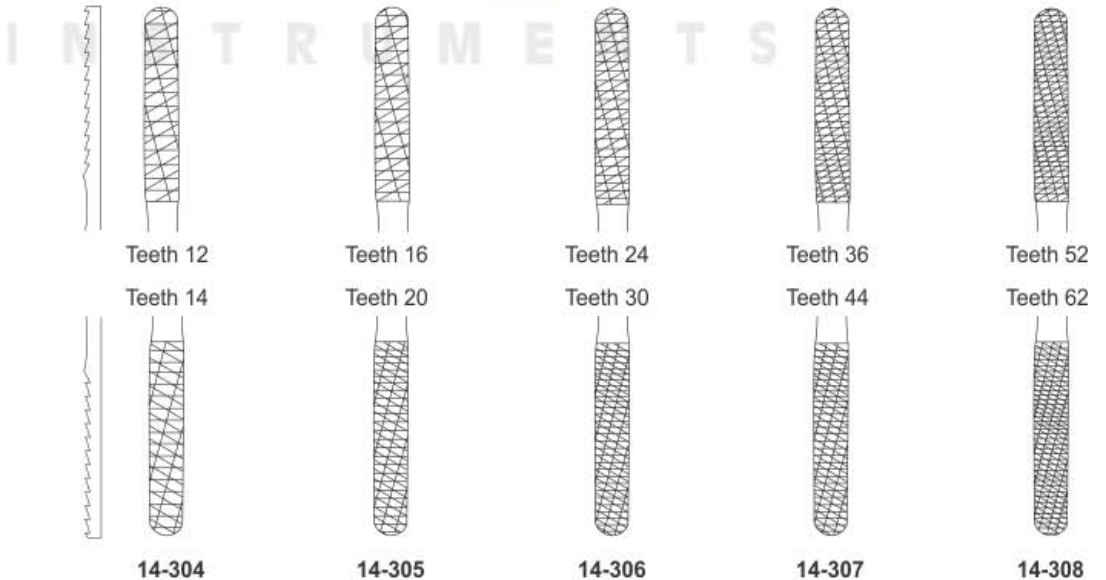

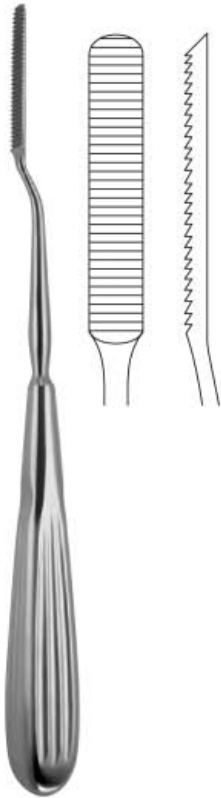

Cottle Nasal Saw
 14-309
 21 cm 8 1/4"



Maltz Nasal Saw

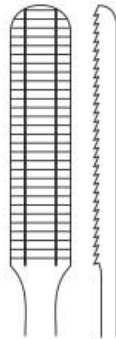

14-310
 17 cm 6 3/4"
 34 mm x 7 mm
 Pushing cut



14-311
 17 cm 6 3/4"
 34 mm x 7 mm
 Drawing cut



Aufrecht Nasal Saw
 Glabella Rasp,
 backward cutting



14-312
 21 cm 8 1/4"
 Pushing cut



14-313
 21 cm 8 1/4"
 Drawing cut

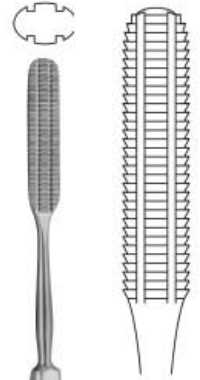

14-314
 17.5 cm 7"
 40 mm X 9 mm

Maltz Nasal Saw



Wiener Nasal Saw



14-315
 18 cm 7"
 3.5 mm Ø
 Antrum rasps



14-316
 18 cm 7"
 3.5 mm Ø
 Antrum rasps



Gallaher Nasal Saw



14-317
 16 cm 6 1/4"



14-318
 16 cm 6 1/4"



14-319
 16 cm 6 1/4"



Fomon Nasal Saw
 14-320
 21 cm 8 1/4"

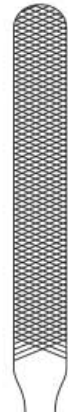

adenoid cures

Couteaux a vegetations adenoides

Cuchillos para vegetaciones adenoides

Adenotomi



14-321
21 cm 8 1/4"



14-322
21 cm 8 1/4"



14-325
22 cm 8 3/4"



14-326
22 cm 8 3/4"



14-323
21 cm 8 1/4"



14-324
21 cm 8 1/4"



14-327
22 cm 8 3/4"



14-328
22 cm 8 3/4"

**St. Clair-Thomson
Adenoid Curette**

**Barnhill
Adenoid Curette**



14-329
22 cm 8 3/4"
Straight



14-330
22 cm 8 3/4"
Straight



14-331
22 cm 8 3/4"
Straight



14-335
22 cm 8 3/4"
Curved



14-336
22 cm 8 3/4"
Curved



14-337
22 cm 8 3/4"
Curved



14-332
22 cm 8 3/4"
Straight



14-333
22 cm 8 3/4"
Straight



14-334
22 cm 8 3/4"
Straight



14-338
22 cm 8 3/4"
Curved



14-339
22 cm 8 3/4"
Curved



14-340
22 cm 8 3/4"
Curved

**Beckmann
Adenoid Curette**

**Beckman
Adenoid Curette**

adenoid currettes
Couteaux a vegetations adenoides
Cuchillos para vegetaciones adenoides
Adenotomi

La Force

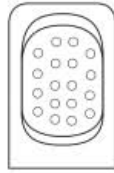

La Force
adenotome
unperforated
Fig 1
14-341
21.6 cm 8 1/2"
25 x 16.0mm
Infant

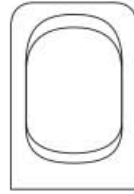

La Force
adenotome
perforated
Fig 1
14-342
21.6 cm 8 1/2"
25 x 19.3mm
Infant

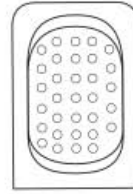

La Force
adenotome
unperforated
Fig 2
14-343
24.1 cm 9 1/2"
26 x 19.3mm
Medium



La Force
adenotome
perforated
Fig 2
14-344
24.1 cm 9 1/2"
26 x 19.3mm
Medium

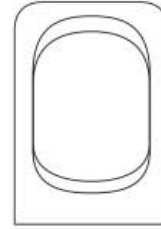

La Force
adenotome
unperforated
Fig 3
14-345
25 cm 10"
30 x 22.2mm
Large

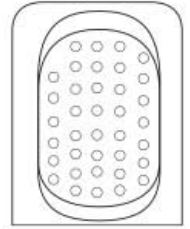

La Force
adenotome
perforated
Fig 3
14-346
25 cm 10"
30 x 22.2mm
Large



14-347
20 cm 8"
X = 3 mm
Straight
14-348
20 cm 8"
Straight
X = 4 mm
14-349
20 cm 8"
Straight
X = 5 mm

Ballenger Knife

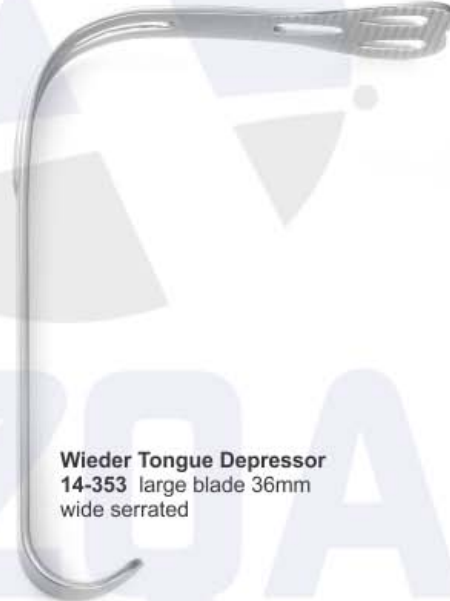

14-350
20 cm 8"
X = 3 mm
Bayonet
14-351
20 cm 8"
Bayonet
X = 4 mm
14-352
20 cm 8"
X = 5 mm
Bayonet

Ballenger Knife

Wieder Tongue Depressor
14-353 large blade 36mm
wide serrated

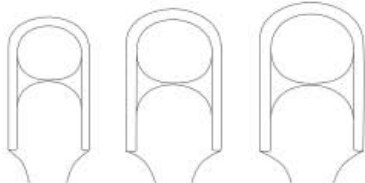

Wieder Tongue Depressor
14-354 43.5mm
width blade



Blade
Fig 1
14-355

Blade
Fig 2
14-356

Blade
Fig 3
14-357

Sluder-Ballenger Tonsil Guillotines & Punch Forceps
14-358
complete set with 3 blades

Sluder-Ballenger Tonsil Guillotines & Punch Forceps Handle
14-359 Handle



14-360
X = 12 cm
13 mm Ø



14-361
X = 15 cm
13 mm Ø

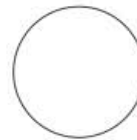

14-362
X = 17 cm
13 mm Ø

Hartmann Tonsil Guillotines & Punch Forceps





Westmacott Nasal Polypus and Septum Forceps
14-363 20 cm 8"



Lubet-Barbon Nasal Polypus and Septum Forceps
14-364 20 cm 8"



Hartmann Nasal Polypus and Septum Forceps
14-365 16 cm 6 1/4"
14-366 20 cm 8"



Tilley Nasal Polypus and Septum Forceps
14-367 14 cm 5 1/2"



Heymann-Knight Nasal Polypus and Septum Forceps
14-368 18 cm 7"



Craig Nasal Polypus and Septum Forceps
14-369 18 cm 7"



Knight Nasal Polypus and Septum Forceps
14-370 18 cm 7"



Littauer Nasal Polypus and Septum Forceps
14-371 18 cm 7"

Ohrpolypenzangen

Pinzas para pólipos auriculares

Pinces pour polypes auriculaires

Pinze per polipi auricolari



Littauer Ear Polypus Forceps
14-372
12 cm 4 3/4"

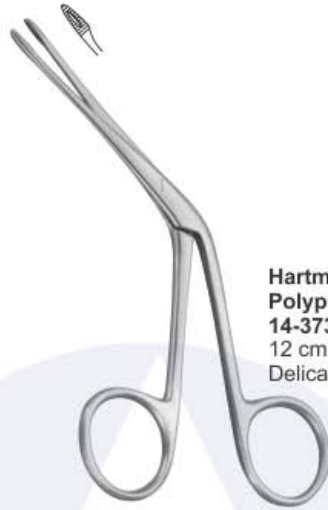

Hartmann Ear Polypus Forceps
14-373
12 cm 4 3/4"
Delicate jaw



Hartmann Ear Polypus Forceps
14-374
14 cm 5 1/2"
Normal jaw



Quire Ear Polypus Forceps
14-375
10.5 cm 4 1/4"
Foreign body lever



Buck Ear Polypus Forceps
14-376
11.5 cm 4 1/2"
Foreign body forceps



Wilde Nasal Dressing Forceps
14-377
16.5cm 6 1/2"
angular

AZQA
INSTRUMENTS

TONSIL INSTRUMENTS



Troeltsch Dressing Forceps
14-378
11cm, 4 1/2"



Troeltsch Dressing Forceps
14-379
13 cm, 5"



Lucae Dressing Forceps
14-380
14 cm, 5 1/2"



Jansen Dressing Forceps
14-381
16 cm, 6 1/4"

Näsenpolypenzangen, Nasentamponzange

Pinzas para pólipos nasales, Pinza nasale para tamponiamento

Pinces à polypes nasales, Pince à pansement pour le nez

Pinze per polipi nasali, Pinza per tamponamento nasale



Heymann Nasal Dressing Forceps

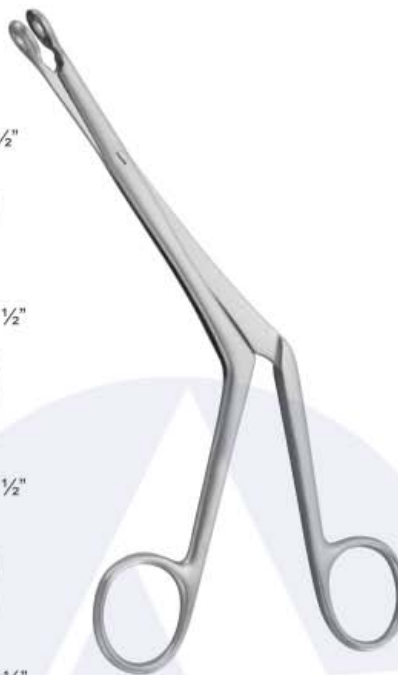
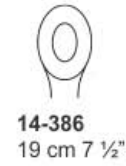

Bruenings Nasal Cutting Forceps

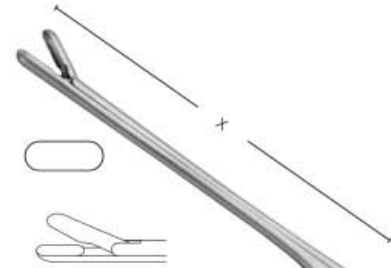

14-389
X = 12 cm 4 3/4"
3.5 mm X 10 mm



14-390
X = 12 cm 4 3/4"
3.5 mm X 10 mm



Takahashi Nasal Cutting Forceps

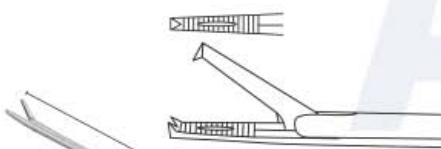

Noyes Nasal Dressing Forceps
14-391
X = 11 cm 3 1/2"
1 X 2



Luc Nasal Cutting Forceps

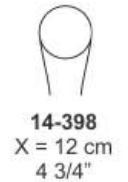

	X = 12 cm	14-399 a - 3.0 mm	14-400 a - 3.5 mm	14-401 a - 4.5 mm	14-402 a - 5.0 mm	14-403 a - 5.5 mm
	X = 12 cm	14-404 a - 3.0 mm	14-405 a - 3.5 mm	14-406 a - 4.5 mm	14-407 a - 5.0 mm	
	X = 12 cm	14-408 a - 3.0 mm	14-409 a - 3.5 mm	14-410 a - 4.5 mm		
	X = 18 cm	14-411 a - 3.0 mm	14-412 a - 3.5 mm	14-413 a - 4.5 mm	14-414 a - 5.0 mm	14-415 a - 5.5 mm
	X = 18 cm	14-416 a - 3.0 mm	14-417 a - 3.5 mm	14-418 a - 4.5 mm	14-419 a - 5.0 mm	



**Weil-Blakesley
Nasal Cutting Forceps**

14-420 X = 12 cm	14-421 X = 12 cm	14-422 X = 12 cm	14-423 X = 12 cm

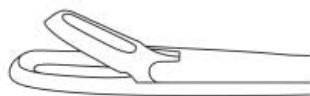

**Myles Nasal
Cutting Forceps**

14-424 X = 12 cm 2.0 mm X 10 mm	14-425 X = 12 cm 2.5 mm X 12 mm	14-426 X = 12 cm 3 mm X 14 mm



**Hartmann Nasal
Cutting Forceps**

Keilbeinstanzen

Pinzas para esfenoides

Pinces pour le sinus sphénoïdal

Pinze sfenoidali taglienti



Citelli Bone Ear Rongeurs
14-427 17 cm 6 3/4"
X = 60 mm



Kerrison Bone Ear Rongeurs
14-428 20 cm 8"
X = 80 mm



Beyer Bone Ear Rongeurs
14-429 14 cm 1 mm
14-430 19 cm 2 mm



Hajek Rongeur punch
14-431
X - 14 cm
4 mm X 4 mm
14-432
X - 14 cm
4 mm X 4 mm

Hajek-Kofler Rongeur punch
14-433
X - 14 cm
3.5 mm X 3.5 mm
14-434
X - 14 cm
3.5 mm X 3.5 mm



Hajek-Claus Rongeur punch
14-435 20 cm



Hajek-Kofler Rongeur punch
14-436
X - 18 cm
3.5 mm
Shaft rotates 360°



Bruenings-Brunk
14-437
19 cm 7 1/2"
Antrum Retractor
Serrated



Ritter-Halle
14-438 16 cm 6 1/4"
2.5 mm Ø
14-439 16 cm 6 1/4"
3.0 mm Ø
14-440 16 cm 6 1/4"
4.0 mm Ø
Forntal sinus bougies



Cottle
14-441
1.2 cm 4 3/4"
Handle



Cottle
14-442
7 mm
Guide support
for osteotomes



Cottle
14-443
65 mm X 30 mm X 30 mm
Cartilage crusher



Cottle-Walsham
Septum Forceps



14-444
23 cm 9"
Straight



14-445
23 cm 9"
Left



14-446
23 cm 9"
Right



Ash Septum
Forceps
14-447
23 cm 9"



Septumzangen
Pinces pour la cloison nasale
Pinzas para el tabique nasal
Pinze per il setto nasale

**Middleton-Jansen
Septum Forceps**
14-448 19 cm



**Middleton-Jansen
Septum Forceps**
14-449 19 cm

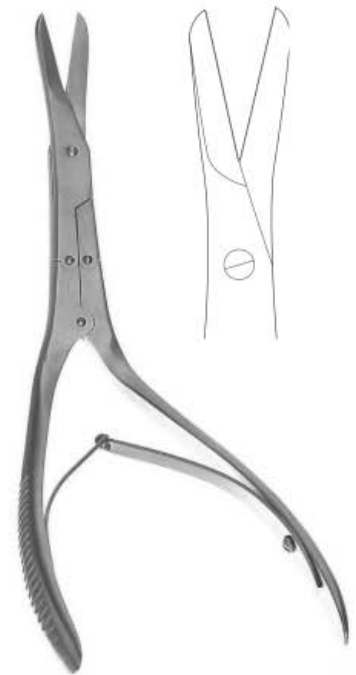

**Caplan Septum
Forceps**
14-450 20 cm
Toothed



**Rubin Septum
Forceps**
14-451
21 cm
Protection cap



Killian
14-452
20 cm
Laryngotomy scissors



**Reichert Epiglottis
Retractor**
14-453
23 cm



**Aufrecht Retractor
Speculum**
14-454
16.5cm
solid blade

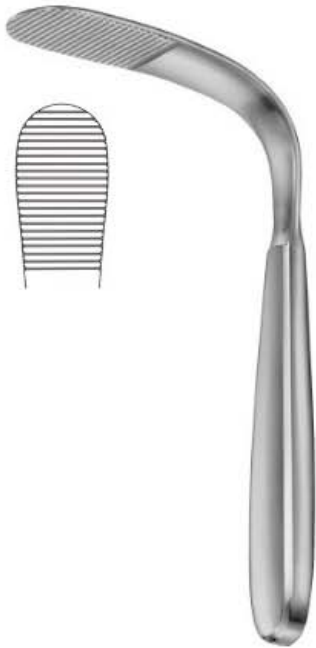

Tobold
14-455
Tongue Depressor
14.5 cm



Hartmann
14-456
15 cm



Cheek Retractor
14-457
14.5 cm



Cawood-Minnesota
14-458
Cheek Retractor
15 cm



Sternberg
14-459
Lip and Cheek Retractor
14 cm



Obwegeser
14-460
Cheek Retractor
12 cm



Vestibulum Retractor
14-461
14 cm



Oringer
Lip and Cheek Retractor
14-462 9.5cm
14-463 10 cm
14-464 10.5cm
14-465 11 cm



Obwegeser
14-466
 Channel Retractor
 17 cm



Obwegeser
14-467
 Chin Retractor
 16.5 cm



Retractor
14-468
 18.5 cm



Tongue Spatula
14-469
 16 cm



Martin
14-470
 Tongue Spatula
 18.5 cm



Haberer flexible
 Abdominal and Intestinal
14-471
 spatulas 33cm (40mm)



Bruenings Tongue
Depressors
14-472
 19 cm



Obwegeser
14-473
 Soft Tissue Retractor
 21.5 cm



Obwegeser
14-474
 Nasal Spine Retractor
 22 cm



Obwegeser
14-475
 Ramus Retractor
 22 cm



Doyen
14-476
 Tongue Spatula
 13.5 cm



**Whitehead
Mouth Gag**
14-477 11 cm 4 1/4"
14-478 13 cm 5"
14-479 15 cm 6"



**Heister
Mouth Gag**
14-484
13 cm 5"



**Mauder
Mouth Gag**
14-485
10 cm 4"
4 mm Ø
Wood



**Jennings
Mouth Gag**
14-480 9 cm 3 1/2"
14-481 11 cm 4 1/4"
14-482 13 cm 5"
14-483 15 cm 6"



Molt Mouth Gag
14-486
11 cm 4 1/4"
For children



Molt Mouth Gag
14-487
14 cm 5 1/2"
For adults



**Denhart
Mouth Gag**
14-488
12 cm 4 3/4"



**Fergusson-Ackland
Mouth Gag**
14-489
14.5 cm 5 3/4"



**Roser-Konig
Mouth Gag**
14-490
16 cm 6 1/4"
14-491
19 cm 7 1/2"



**Dingmann Cleft Palate
Repair Mouth Gag**
14-492
14.5 cm



14-493
Mouth Gag
Blade
55 mm X 25 mm



14-494
Mouth Gag
Blade
60 mm X 27 mm



14-495
Mouth Gag
Blade
70 mm X 30 mm



Kilner-doughty Mouth Gag
14-496

Complete with frame, 3 tongue depressors and 2 adjustable lateral blades

14-497
Mouth Gag
Blade
28 mm X 65 mm

14-498
Mouth Gag
Blade
32 mm X 75 mm

14-499
Mouth Gag
Blade
37 mm X 80 mm

14-500
Mouth Gag
Blade
40 mm X 90 mm

14-501
Mouth Gag
Blade
45 mm X 100 mm

**Complete Kilner-doughty
Mouth Gag Set With 3 Blades**
14-502



**Kilner-Doughty Mouth
Gag Handle**
14-503



**Negus Mouth
Gag Complete
Set**
14-504



14-505
Mouth Gag
Blade
20X70mm



14-506
Mouth Gag
Blade
30X80mm



14-507
Mouth Gag
Blade
33X95mm



**Negus Mouth
Gag Handle**
14-508

**Davis-boyle Mouth
Gag Complete Set
with five blades
14-509**



14-510
Mouth Gag
Blade
20 mm X 26 mm



14-511
Mouth Gag
Blade
23 mm X 65 mm



14-512
Mouth Gag
Blade
24 mm X 80 mm



14-513
Mouth Gag
Blade
25 mm X 93 mm



14-514
Mouth Gag
Blade
26 mm X 108 mm



**Davis-Boyle
Mouth Gag
Handle
14-515**



14-517
Mouth Gag Blade
23 mm X 70 mm



14-518
Mouth Gag Blade
25 mm X 86 mm



**McLvor Mouth Gag
Handle
14-520**



**Roser-Knig
14-521
Mouth Gag
13.5 cm**

**McLvor Mouth Gag
Complete Set
14-516**

14-519
Mouth Gag Blade
26 mm X 100 mm



Jackson
14-522
22 cm 8 3/4"
Laryngeal forceps



Marschik
14-523
22 cm 8 3/4"
Tonsil seizing forceps



Blohmke
Tonsil
Forceps
14-524
20 cm 8"



Colver Tonsil
Forceps
14-525
19 cm 7 1/2"
Straight
14-526
19 cm 7 1/2"
Curved



White Tonsil
Seizing Forceps
14-527
19.1 cm 7 1/2"
14-528
23 cm 9"



Museux
Tonsil Holding
Forceps
14-529 20 cm 8"

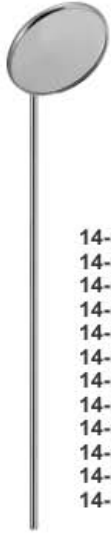

- 14-530 8 mm Ø
- 14-531 10 mm Ø
- 14-532 12 mm Ø
- 14-533 14 mm Ø
- 14-534 16 mm Ø
- 14-535 18 mm Ø
- 14-536 20 mm Ø
- 14-537 22 mm Ø
- 14-538 24 mm Ø
- 14-539 26 mm Ø
- 14-540 28 mm Ø
- 14-541 30 mm Ø

Laryngeal mirrors



Laryngeal Mirrors
Handle
14-541
10 cm



Laryngeal Mirrors
with Handle

- 14-542 8 mm Ø
- 14-543 10 mm Ø
- 14-544 12 mm Ø
- 14-545 14 mm Ø
- 14-546 16 mm Ø
- 14-547 18 mm Ø
- 14-548 20 mm Ø
- 14-549 22 mm Ø
- 14-550 24 mm Ø
- 14-551 26 mm Ø
- 14-552 28 mm Ø
- 14-553 30 mm Ø



Michel Moveable
Mirror

- 14-554 10 mm Ø
- 14-555 12 mm Ø
- 14-556 14 mm Ø
- 14-557 16 mm Ø
- 14-558 18 mm Ø

GOITRE GRASPING FORCEPS - GOITRE ENUCLEATOR



Mastin Goitre
Grasping Forceps
14-559
17 cm



Lahey Goitre
Grasping Forceps
14-560 15 cm
14-561 20 cm



Kocher Goitre
Enucleator
14-562
16 cm



Kocher Goitre
Enucleator
14-563
16 cm
With Hole



Laborde Trachea Dilator 3 Prong
14-564 14 cm

Trousseau Trachea Dilator 2 Prong
14-565 14 cm

Bowlby Trousseau Tracheal Dilator Bowlby Paediatric
14-566 15.5 cm



Uckermann Trachea Tubes
14-567
13 cm
10 mm Ø



Luer-Standard Trachea Tubes
German silver

- 14-568 4 mm Ø
- 14-569 5 mm Ø
- 14-570 6 mm Ø
- 14-571 7 mm Ø
- 14-572 8 mm Ø
- 14-573 9 mm Ø
- 14-574 10 mm Ø
- 14-575 11 mm Ø
- 14-576 12 mm Ø
- 14-577 13 mm Ø



Chevalier-Jackson Trachea Tubes
German silver

- 14-578 4 mm Ø
- 14-579 5 mm Ø
- 14-580 6 mm Ø
- 14-581 7 mm Ø
- 14-582 8 mm Ø
- 14-583 9 mm Ø
- 14-584 10 mm Ø
- 14-585 11 mm Ø
- 14-586 12 mm Ø
- 14-587 13 mm Ø

Wundhäkchen, Mikrohäkchen
Ganchito, Micro Ganchitos

Crochet, Micro crochetes
Divaricatore, Micro Divaricatori

Bruenings Retractor

- 14-588 20 cm
- 14-589 30 cm
- 14-590 40 cm
- 14-591 50 cm
- 14-592 60 cm

Bruenings Retractor

14-593
20 cm

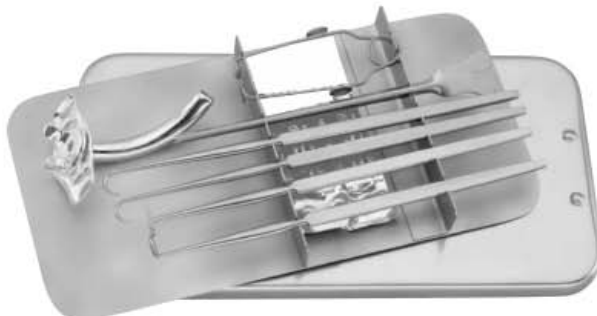
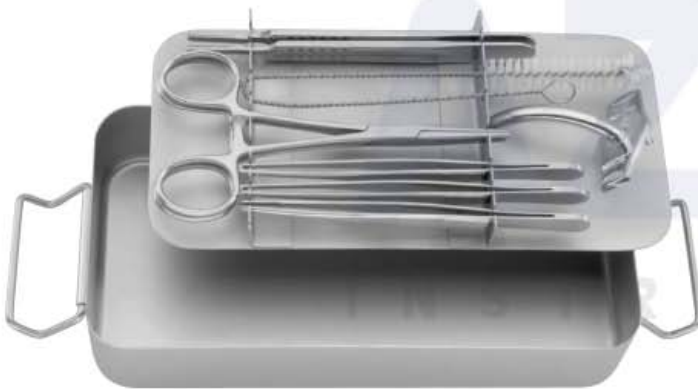

Huber Retractor
14-594

TRACHEOTOMY SET

14-595

Tracheotomy Broncho-Oesophagoscopy Forceps set, In metal case, Consisting of:

- 200mm x 105mm x 30mm
- 1 Handle, 1 Blade
- 1 Handle, 1 Blade
- 1 Dressing Forceps, 130mm
- 2 Tissue Forceps, 1 x 2 teeth, 130mm
- 2 Rochester Pean Hemostatic forceps, 130mm
- 1 Grooved director, 130mm
- 1 Bose trachea dilator
- 2 iterson trachea retractors, blunt
- 1 Bose trachea retractor, 160mm, sharp, right
- 1 Bose trachea retractor, 160mm, left, right
- 1 Luer trachea tube, standard, 7mm, german silver
- 1 Luer trachea tube, standard, 8mm, german silver
- 1 Cleaning brush

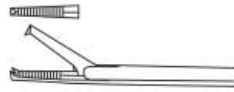

**Hartman
Ear Forceps
14-596**



**Hartmann
Ear Forceps
14-597
X = 8.5 cm
14-598
X = 14 cm**

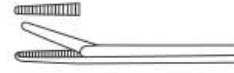

**Hartmann
Ear Forceps
14-599
X = 8.5 cm
14-600
X = 14 cm
14-601
X = 16 cm**

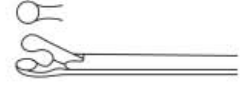

**Hartmann
Ear Forceps
14-602 2 mm Ø
X = 8.5 cm
14-603 2.5 mm Ø
X = 8.5 cm
14-604 3 mm Ø
X = 8.5 cm**



**Hartmann
Ear Forceps
14-606**

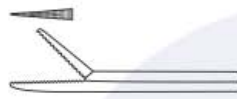

**Hartmann-Wullstein
Ear Forceps
14-606
X = 8.5 cm**



**Hartmann-Wullstein
Ear Forceps
14-607
1 mm Ø
X = 8.5 cm**



**Hartmann-Weingartner
Ear Forceps
14-608
X = 8.5 cm**



**Duckbill
Ear Forceps
14-609**



**Weingartner
Ear Forceps
14-610**



**Strümpel
Ear Forceps
14-611**



**Hartmann-hoffmann
Ear Forceps
14-612**

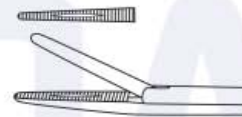

**Hartmann-Noyes
Ear Forceps
14-613
X = 9 cm**



**Struempel
Ear Forceps
14-614 0°
X = 8.5 cm**



**Struempel
Ear Forceps
14-615 45°
X = 8.5 cm**



**Struempel
Ear Forceps
14-616 90°
X = 8.5 cm**

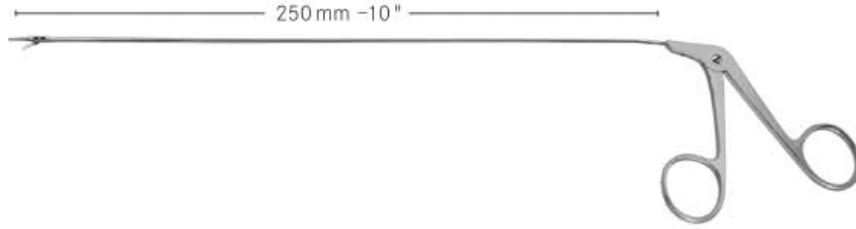

Micro Alligator Scissors

14-617 Straight	14-618 Straight, Horizontal	14-619 Angled up	14-620 Angled up, Horizontal	14-621 Curved right	14-622 Curved left

Alligator Forceps

14-623 Straight, Serrated	14-624 Straight, Horizontal	14-625 Angled up, Horizontal	14-626 Curved right	14-627 Curved left

Micro Alligator Cup shaped forceps
○ 2.5 mm

14-628 Straight	14-629 Angled up	14-630 Angled up, Horizontal	14-631 Curved right	14-632 Curved left

Micro Alligator Cup shaped forceps
○ 3 X 5 mm

14-633 Oval

BRONCHO OESOPHAGOSCOPY FORCEPS



- 14-634**
X = 30 cm
- 14-635**
X = 40 cm
- 14-636**
X = 50 cm
- 14-637**
X = 60 cm

- 14-638**
X = 30 cm
- 14-639**
X = 40 cm
- 14-640**
X = 50 cm
- 14-641**
X = 60 cm

- 14-642**
X = 30 cm
- 14-643**
X = 40 cm
- 14-644**
X = 50 cm
- 14-645**
X = 60 cm

- 14-646**
X = 30 cm
- 14-647**
X = 40 cm
- 14-648**
X = 50 cm
- 14-649**
X = 60 cm

**Chevalier-Jackson
Broncho
Oesophagoscope
Forceps**



- 14-650**
X = 30 cm
- 14-651**
X = 40 cm
- 14-652**
X = 50 cm
- 14-653**
X = 60 cm



- 14-654**
X = 30 cm
- 14-655**
X = 40 cm
- 14-656**
X = 50 cm
- 14-657**
X = 60 cm



- 14-658**
X = 30 cm
- 14-659**
X = 40 cm
- 14-660**
X = 50 cm
- 14-661**
X = 60 cm

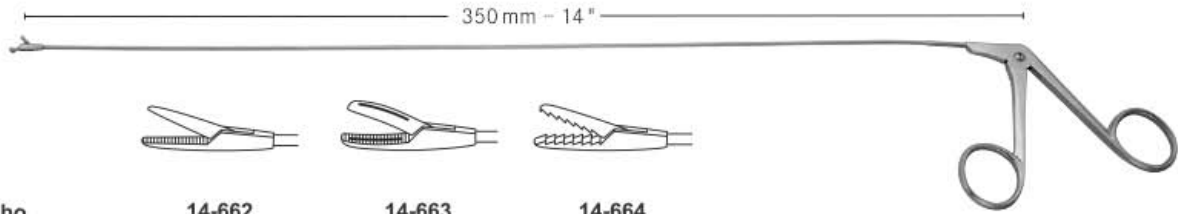

Grasping Broncho Oesophagoscopy Forceps



- 14-662**
Straight,
Serrated
- 14-663**
Straight,
Fenestrated
- 14-664**
Straight

Cup shaped Broncho Oesophagoscopy Forceps
 ○ 3 mm



- 14-665**
Straight
- 14-666**
Angled up
- 14-667**
Angled up,
Horizontal
- 14-668**
Curved right
- 14-669**
Curved left

Cup shaped Broncho Oesophagoscopy Forceps



- 14-670**
Straight
- 14-671**
Angled up
- Universal Broncho Oesophagoscopy Forceps**
- 14-672**
Curved left

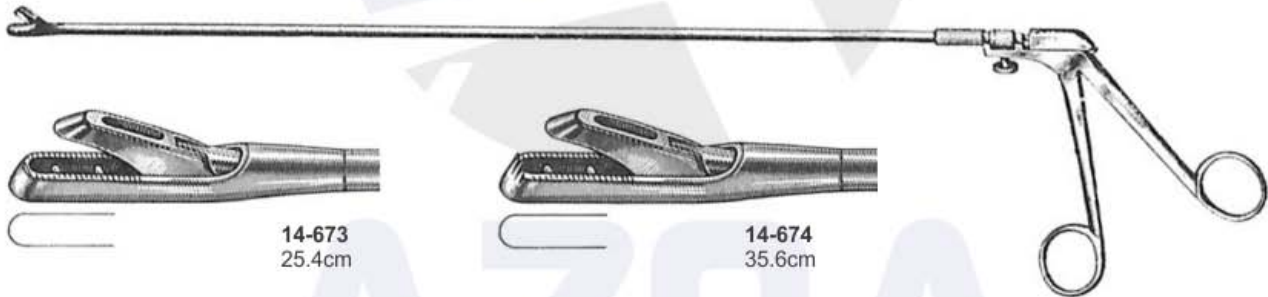

14-673
25.4cm

14-674
35.6cm

Yeoman Biopsy Forceps
 with Rotating Shafts, straight
 4 X 8 mm bite, with basket

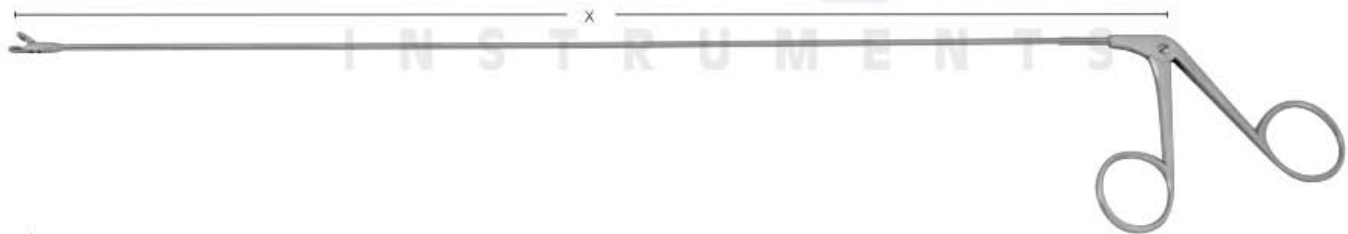

- | | | | |
|---|---|--|---|
| <p>14-675
X = 40 cm
14-676
X = 50 cm
14-677
X = 60 cm
Straight</p> | <p>14-678
X = 40 cm
14-679
X = 50 cm
14-680
X = 60 cm
Straight,
Serrated</p> | <p>14-681
X = 40 cm
14-682
X = 50 cm
14-683
X = 60 cm
Straight,
Fenestrated</p> | <p>14-684
X = 40 cm
14-685
X = 50 cm
14-686
X = 60 cm
Straight</p> |
|---|---|--|---|

Punch Broncho Oesophagoscopy Forceps



Cup shaped Broncho Oesophagoscopy Forceps



14-687
X = 40 cm
4 mm
14-688
X = 50 cm
4 mm
14-689
X = 60 cm
4 mm
Straight

14-690
X = 40 cm
4 mm
14-691
X = 50 cm
4 mm
14-692
X = 60 cm
4 mm
Angled up

14-693
X = 40 cm
4 mm
14-694
X = 50 cm
4 mm
14-695
X = 60 cm
4 mm
Angled up, horizontal

14-696
X = 40 cm
4 mm
14-697
X = 50 cm
4 mm
14-698
X = 60 cm
4 mm
Curved right

Cup shaped Broncho Oesophagoscopy Forceps



14-699
X = 40 cm
4 mm
14-700
X = 50 cm
4 mm
14-701
X = 60 cm
4 mm
Curved left

14-702
X = 40 cm
3 mm X 4 mm
14-703
X = 50 cm
3 mm X 4 mm
14-704
X = 60 cm
3 mm X 4 mm
Straight

14-705
X = 40 cm
4 mm X 6 mm
14-706
X = 50 cm
4 mm X 6 mm
14-707
X = 60 cm
4 mm X 6 mm
Straight

14-708
X = 40 cm
4 mm X 8 mm
14-709
X = 50 cm
4 mm X 8 mm
14-710
X = 60 cm
4 mm X 8 mm
Straight



14-711
X = 40 cm
14-712
X = 50 cm
14-713
X = 60 cm
Straight

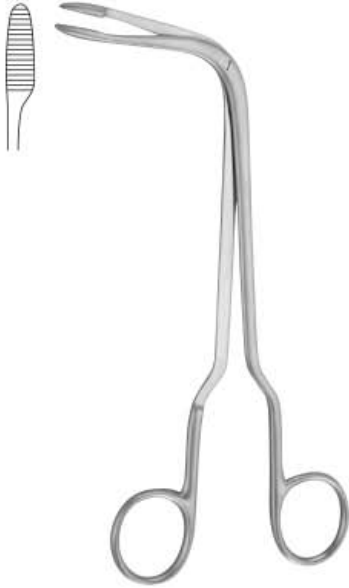

Fraenkel Laryngeal Polypud Forceps
14-714 18 cm



Fraenkel Laryngeal Polypud Forceps
14-715
X = 17 cm
Both jaws articulated



Jurasz Laryngeal Polypud Forceps

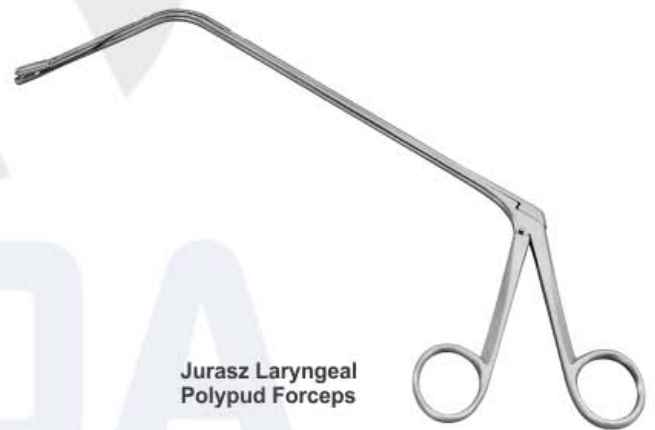

Jurasz Laryngeal Polypud Forceps



14-716
23 cm
Right



14-717
23 cm
Left



14-720
23 cm
Right



14-721
23 cm
Left



14-718
23 cm
Downwards



14-719
23 cm
Upwards



14-722
23 cm
Downwards



14-723
23 cm
Upwards

A Z Q A
I N S T R U M E N T S

INTESTINAL AND RECTAL INSTRUMENTS



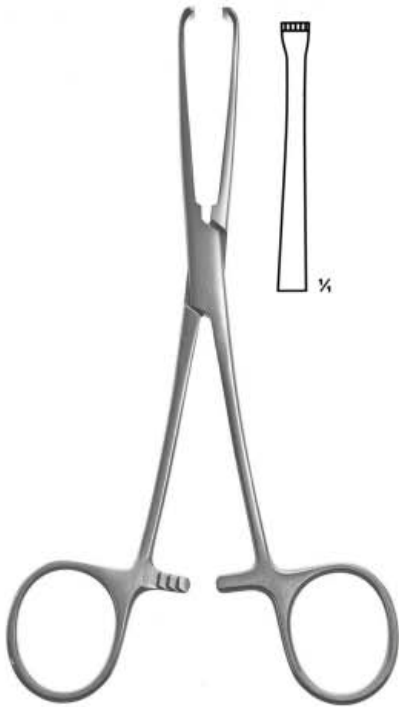

Allis Tissue Forceps
15-001 15 cm
 3 x 4 teeth

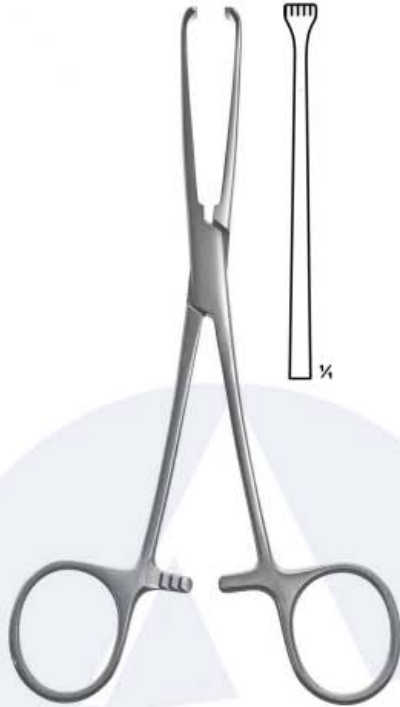

Allis Tissue Forceps
15-002 15.5 cm
 4 x 5 teeth

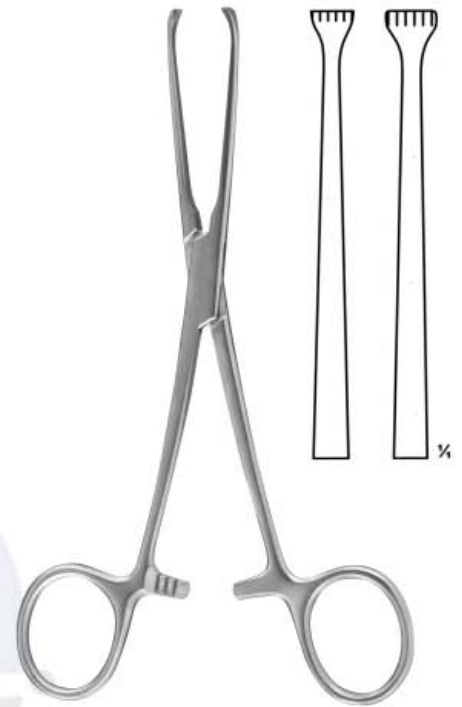

Allis Tissue Forceps
15-003 16 cm
15-004 19 cm
15-005 22 cm
15-006 25.5 cm
 5 x 6 teeth



Baby Allis Tissue Forceps
15-007 12 cm 4 X 5 teeth
15-008 14 cm 4 X 5 teeth
 delicate jaws 4 mm wide



Judd-Allis Tissue Forceps
15-009 19.5 cm
 3 x 4 teeth



Williams Grasp Forceps
15-010 16 cm



Boys-Allis Tissue Forceps
15-011 15.5 cm
 5 x 6 teeth, sharp



Allis Tissue Grasping Forceps



15-012
15.5 cm



15-013
20 cm



15-014
22 cm



15-015
25.5 cm



15-016
30 cm



**Allis-Adair
15-017**
Intestinal and Tissue Grasping Forceps
16 cm



**Thoms-Allis
15-018**
Intestinal and Tissue Grasping Forceps
20.5 cm



Chaput Tissue Forceps
15-019 12.5 cm
2 x 3 teeth, sharp



Tuffier Tissue Forceps
15-020 12.5 cm
5 x 6 teeth, sharp

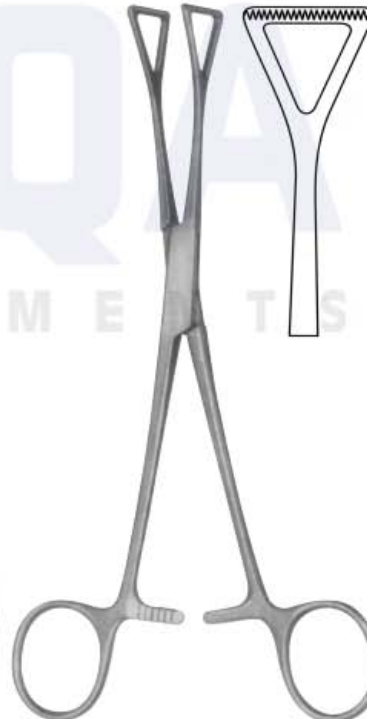

Duval-Collin Grasp Forceps
15-021 18 cm
15-022 20 cm

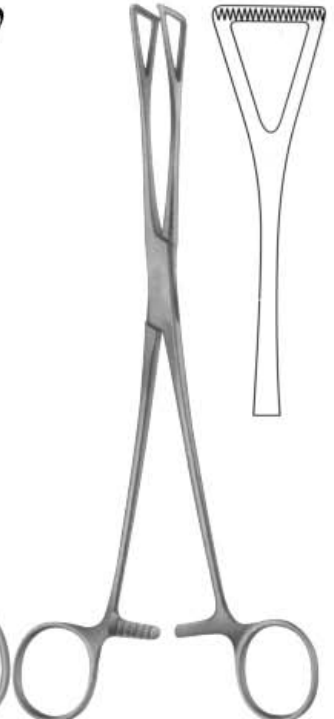

Duval Grasp Forceps
15-023 23 cm



Babcock Seizing Forceps



- 15-024 16 cm
- 15-025 18 cm
- 15-026 20 cm
- 15-027 22 cm



Babcock Tissue Grasping Forceps

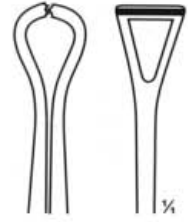

15-028 16 cm



15-029 21.5 cm



Babcock Tissue Grasping Forceps

- 15-030 18 cm
- 15-031 24 cm

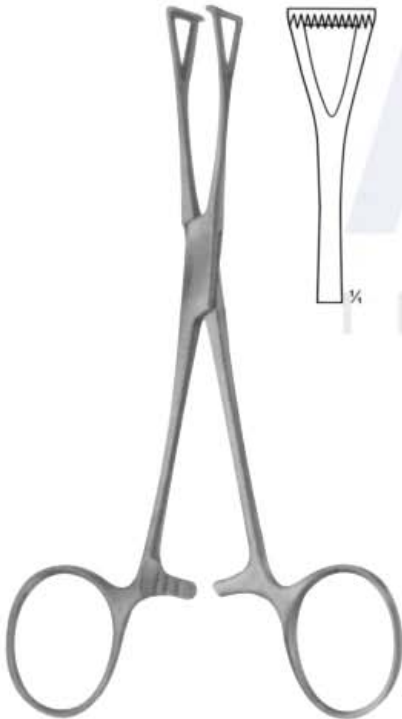

Collin Grasp Forceps
15-032 14 cm



Collin Tissue Grasping Forceps
15-033 19.5 cm



Collin Tissue Grasping Forceps
15-034 23 cm

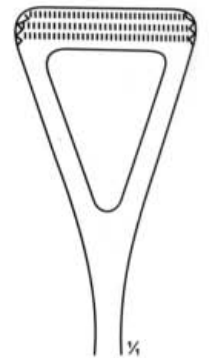



Duval Lung Tissue Forceps
15-035 1" WIDE
DeBakey type jaw, 23 cm

Lovelace Lung Tissue Forceps
15-036 1" WIDE
Angled on Side,
DeBakey type jaw, 19 cm

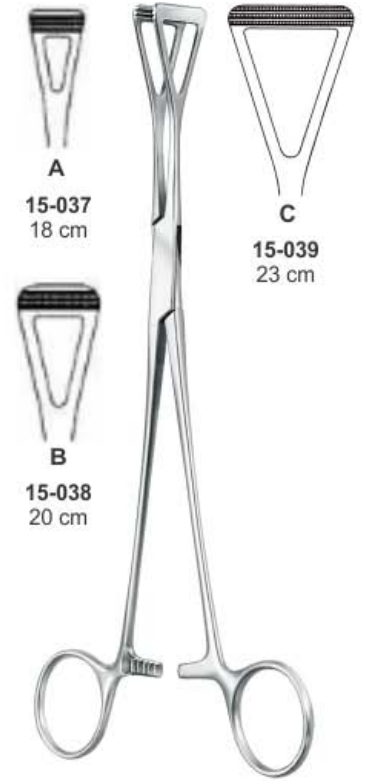

Scheibe
Organ Grasping Forceps



Heywood-Smith
15-040
Polypus Grasping Forceps
21 cm

Duval Tissue Grasping Forceps

Lockwood Grasp Forceps
15-045 20 cm

Allen
Intestinal Clamp
15-046 16 cm



Little Wood Tissue Grasping Forceps
15-047 19 cm
Box Joint



Lane Tissue Grasping Forceps
15-048 12.5 cm
15-049 15 cm
15-050 19 cm



Duval Intestinal and Tissue Grasping Clamp Forceps



15-051 25 cm
15-052 27 cm

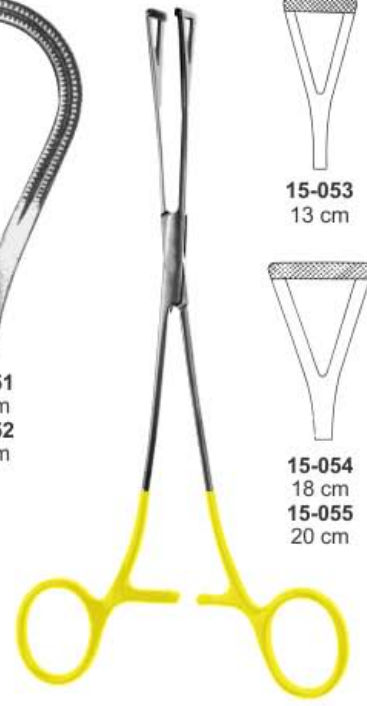

Duval Intestinal & Tissue Grasping Clamp Forceps T.C

15-053 13 cm



15-054 18 cm
15-055 20 cm



Babcock Intestinal & Tissue Grasping Clamp Forceps T.C



15-056 16.5 cm



15-057 20.3 cm



15-058 17.5 cm



15-059 19.5 cm



Stone-Watt Closing Forceps
15-060 15cm



15-061 13 cm Str.

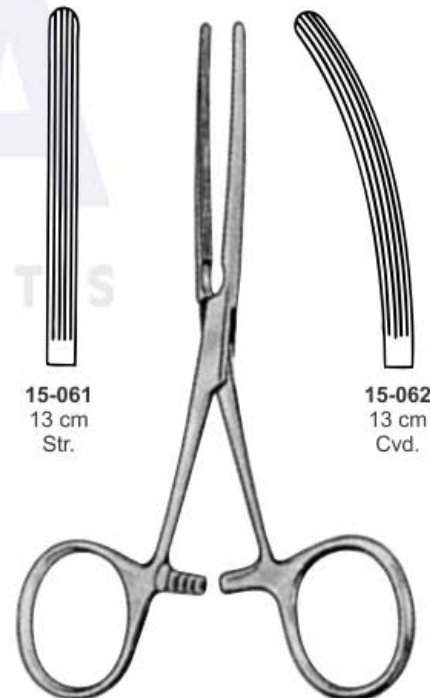

Baby-Kocher Intestinal Forceps Clamps



15-062 13 cm Cvd.

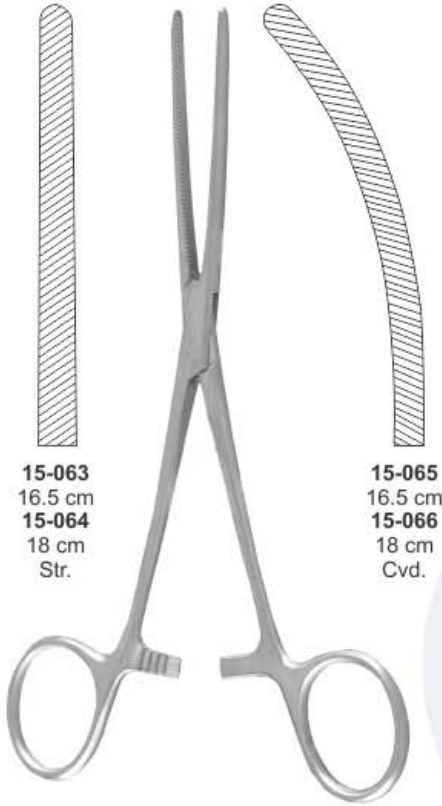

15-063
16.5 cm
15-064
18 cm
Str.

15-065
16.5 cm
15-066
18 cm
Cvd.

Baby-Doyen Intestinal Forceps Clamps

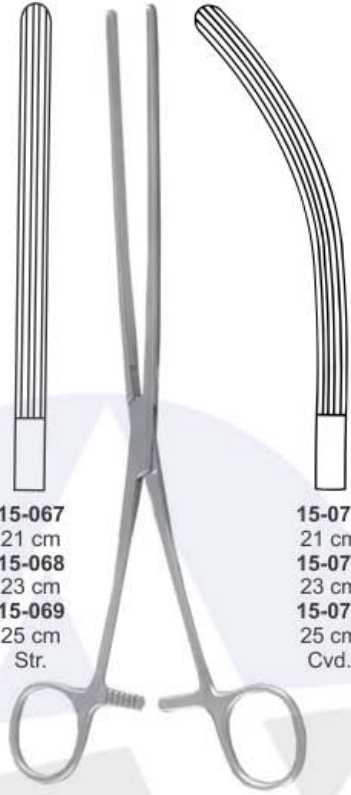

15-067
21 cm
15-068
23 cm
15-069
25 cm
Str.

15-070
21 cm
15-071
23 cm
15-072
25 cm
Cvd.

Mayo-Robson Intestinal Forceps Clamps

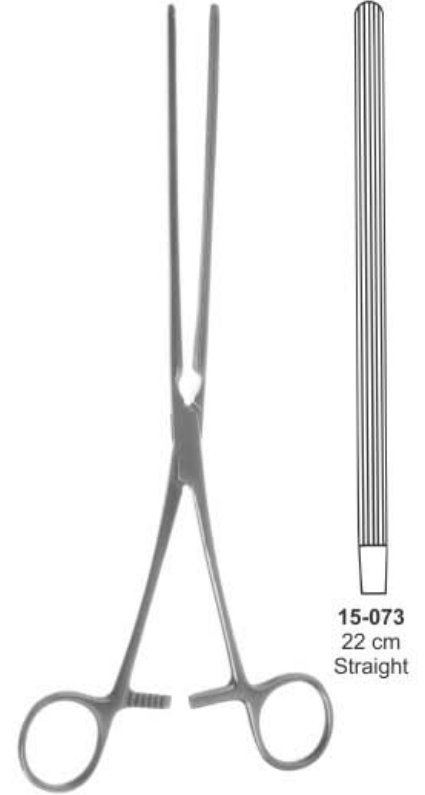

15-073
22 cm
Straight

Kocher Intestinal Forceps Clamps

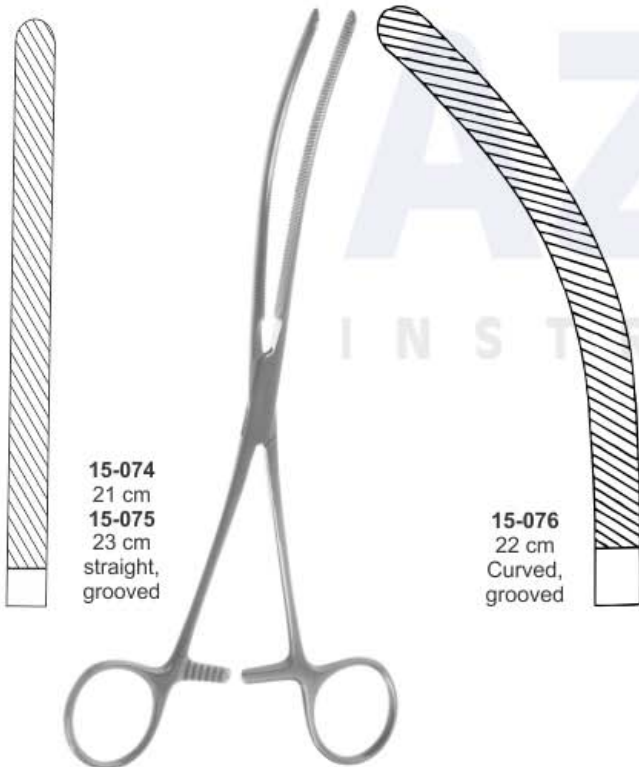

15-074
21 cm
15-075
23 cm
straight,
grooved

15-076
22 cm
Curved,
grooved

Doyen Intestinal Forceps Clamps



15-077 13 cm
15-078 15 cm
15-079 17 cm
15-080 21 cm
15-081 23 cm

Doyen-Baby Intestinal Clamp



Mayo Vessel Clamp
15-082 25.5cm
Curved, 3.8cm
tip



15-083
25 cm
Str.



15-084
25 cm
Cvd.

Mayo-Robson
Intestinal Clamp



15-085
13 cm
15-086
15 cm
15-087
17 cm
15-088
21 cm
15-089
23 cm

Doyen-Baby
Intestinal Clamp



15-090
27 cm
15-091
28 cm

Hayes
Sigmoid Anastomosis Forceps

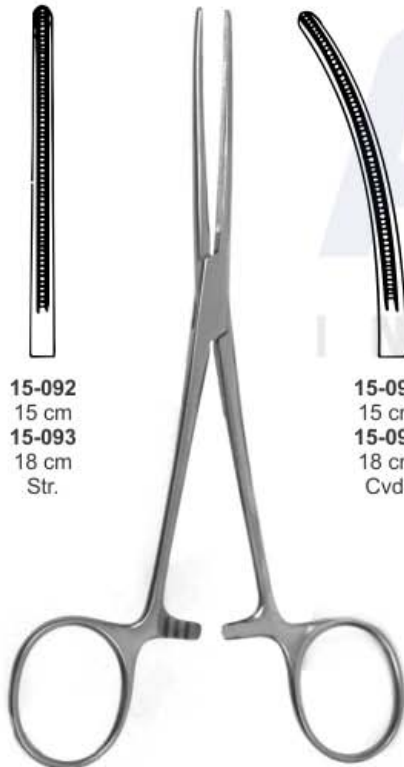

15-092
15 cm
15-093
18 cm
Str.



15-094
15 cm
15-095
18 cm
Cvd.

Bainbridge Intestinal
Forceps Clamps

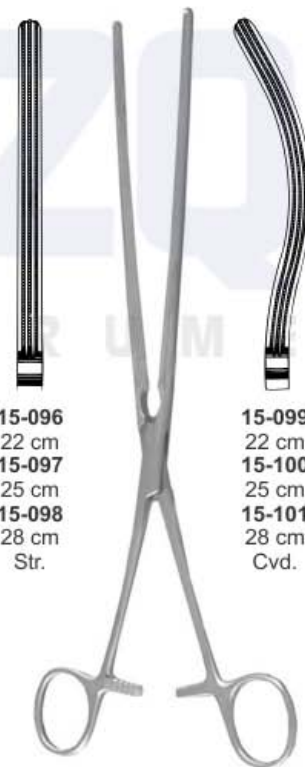

15-096
22 cm
15-097
25 cm
15-098
28 cm
Str.

15-099
22 cm
15-100
25 cm
15-101
28 cm
Cvd.

Kocher Intestinal Forceps
Clamps



15-102 13 cm
15-103 16 cm
15-104 18 cm
15-105 21 cm
15-106 23 cm
Str.

Doyen Intestinal
Forceps Clamps

Polypenfasszange, Darm-anastomosenklemmen

Pince Pour Saisir Polypes, Pincas-clamps Pour Anastomose Intestinale

Pinza Para Coger Pólipos, Clamps Para Anastomosis Intestinales

Pinze Per Afferrare Polipi, Pinze Per Anastomosi Intestinali



Doyen Intestinal Forceps Clamps

- 15-107 13 cm
- 15-108 16 cm
- 15-109 18 cm
- 15-110 21 cm
- 15-111 23 cm Cvd.



Scudder Intestinal Forceps Clamps

- 15-112 25 cm
- 15-113 33 cm Cvd.
- 15-114 25 cm
- 15-115 33 cm Str.

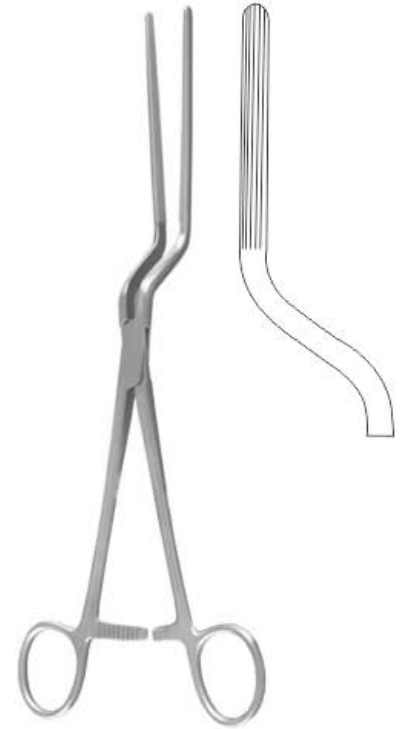

Brunner Intestinal Polyous Grasping Forceps
15-116 24 cm



Resano Intestinal Polyous Grasping Forceps
15-117 30 cm



Fehland Intestinal Polyous Grasping Forceps
15-118 24 cm



Nussbaum Intestinal Forceps Clamps

- 15-119 25 cm Cvd.

- 15-120 25 cm Str.

- 15-121 30cm Str.

- 15-122 30cm Cvd.

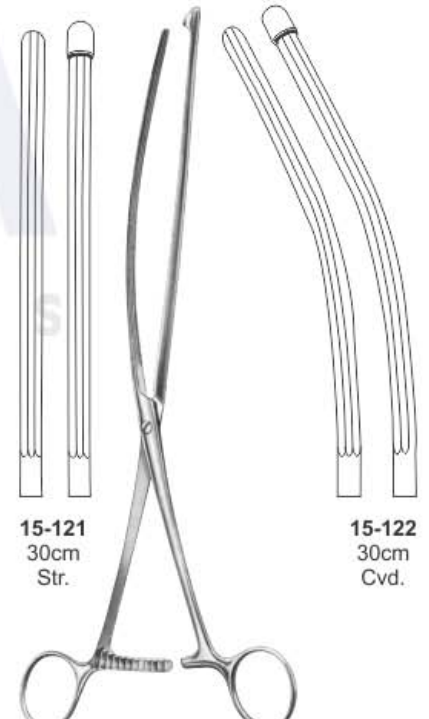

Nussbaum Stomach Intestinal Twin Clamp Forceps

Intestinal & Stomach Twin Clamp Forceps



**Haberer Stomach Intestinal
Twin Clamp Forceps**
15-123 36cm

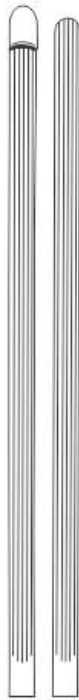

**Roosevelt Stomach Intestinal
Twin Clamp Forceps**
15-124 34cm

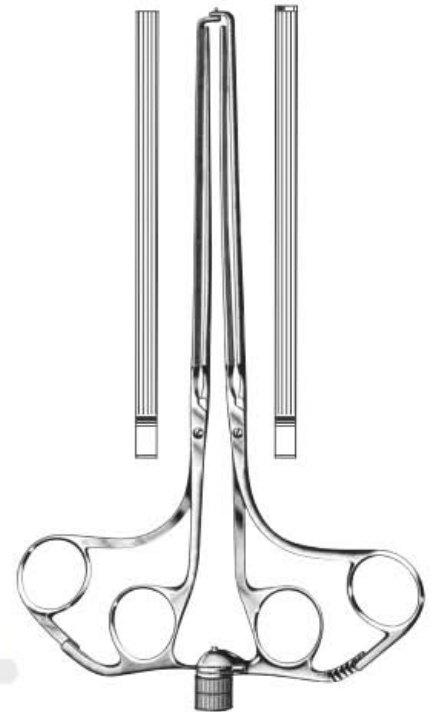

**Abadie Stomach Intestinal
Twin Clamp Forceps**
15-125 22cm
15-126 27cm



**Lane Stomach Intestinal
Clamp Forceps**
15-127
30 cm Str.



**Lane Stomach Intestinal
Clamp Forceps**
15-128
30 cm Cvd.

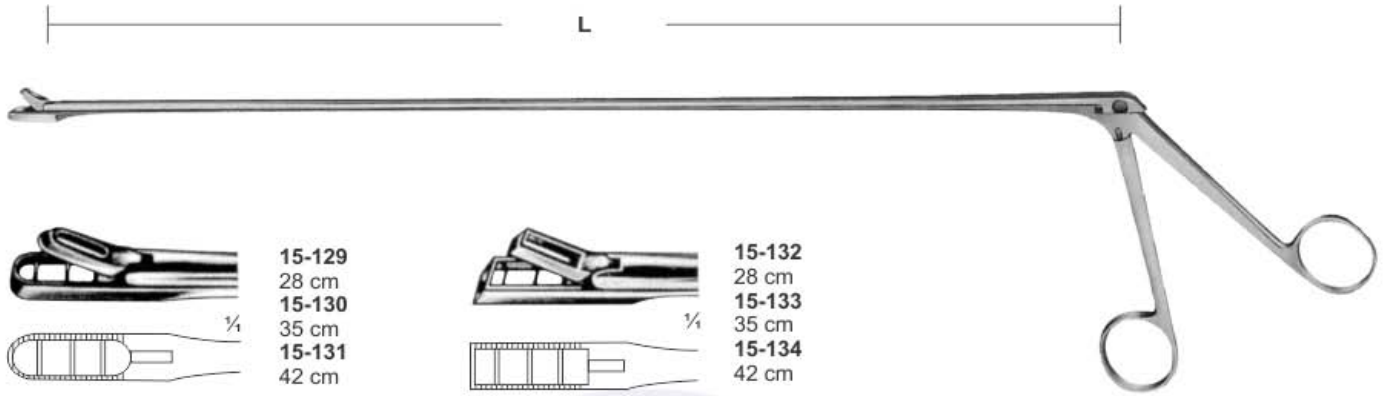

Yeomann Intestinal Polyous Grasping Forceps

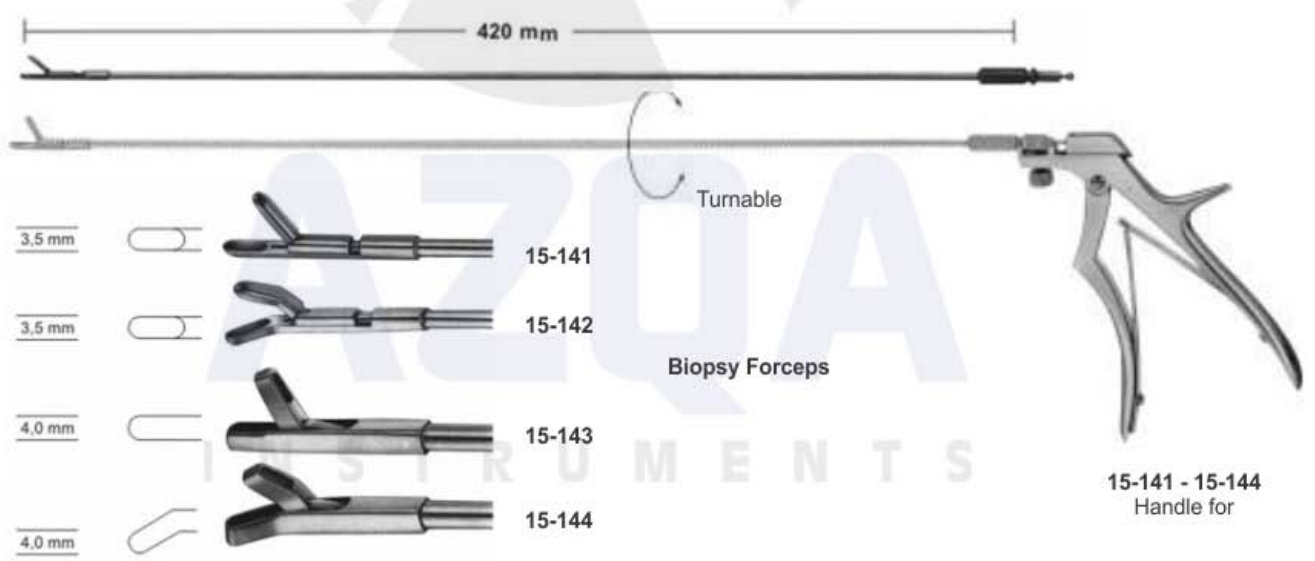
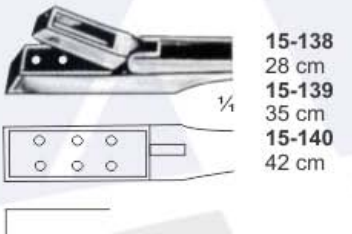
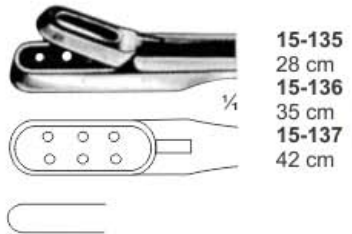
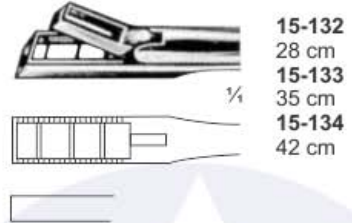
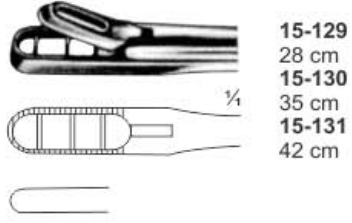

Biopsy Forceps

15-141 - 15-144 Handle for

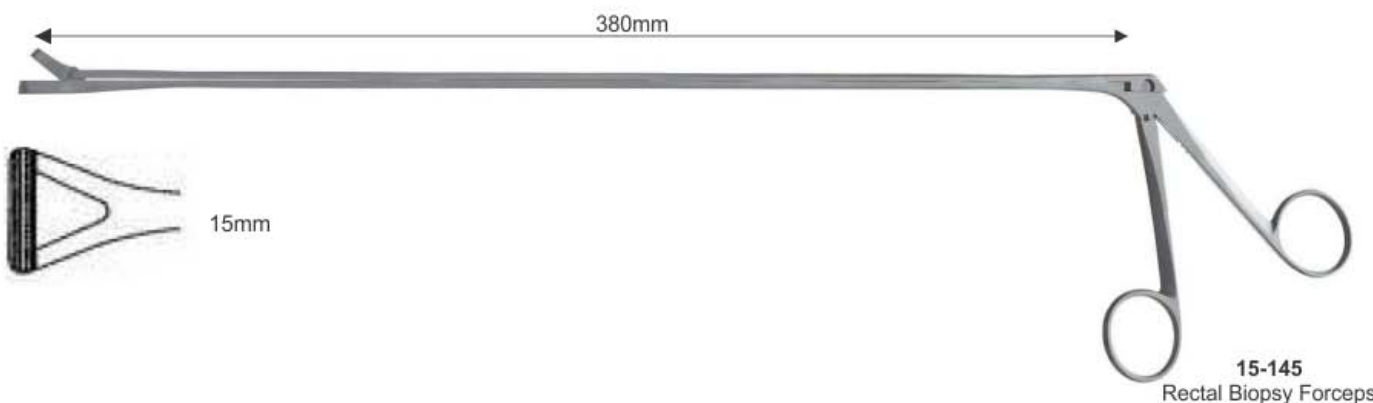

15-145 Rectal Biopsy Forceps

Polypenfasszange, Darm-anastomosenklemmen

Pince Pour Saisir Polypes, Pincés-clamps Pour Anastomose Intestinale

Pinza Para Coger Pólipos, Clamps Para Anastomosis Intestinales

Pinze Per Afferrare Polipi, Pinze Per Anastomosi Intestinali



**De Martel-Wolfson
Clamp Holder
15-146 8.5 cm**



**De Martel-Wolfson
Clamp Holder
15-147 23 cm**



**Stone-Watt
Intestinal Anastomosis Clamp
15-148 8.5cm
15-149 10cm**



**De Martel-Wolfson
15-150 set of 3
anastomosis clamps**



Jaw length
**15-151
5 cm**



Jaw length
**15-152
7 cm**



Jaw length
**15-153
10 cm**



**De Martel-Wolfson
Closing Forceps
15-154
26 cm**



Payr-Baby Crushing Intestinal Clamp

15-155

15 cm
without pin

15-156

15 cm
with pin

Payr Crushing Intestinal Clamp

15-157

21 cm
without pin

15-158

21 cm
with pin

Payr Crushing Intestinal Clamp

15-159

29 cm
without pin

15-160

29 cm
with pin

Payr Crushing Intestinal Clamp

15-161

35 cm
without pin

15-162

35 cm
with pin



90 x 15 mm

Mathieu Rectal Speculum
15-163 19 cm
90 x 15 mm



Sims Rectal Speculum
15-164 15 cm



Sims Rectal Speculum
15-165 15 cm



Ives-Fansler Rectal Speculum
15-166 14.5 cm
22 mm Ø



Pratt Rectal Speculum
15-167 21.5 cm
85 x 25 mm blade

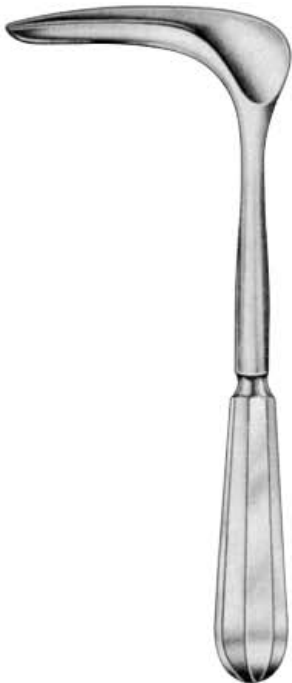

Czerny Rectal Speculum
15-168
22 cm



Barr Rectal Speculum
15-169 80mm
Blade size



15-170
for extra blades



Alan-Parks
15-171
Alan-Parks
14 cm



Smith-Blue Intestinal Rectal Speculum
15-172 15 cm
75 x 23 mm

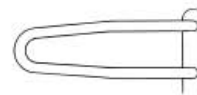

15-173 22 cm
20 x 65 mm
15-174 22 cm
25 x 85 mm
15-175 22 cm
25 x 120 mm
15-176 22 cm
23 x 145 mm



Schulze-Bergmann Intestinal Rectal Speculum



Hirschmann Intestinal Rectal Speculum
15-177
23 mm Ø
proctoscope
working length: 145 mm



15-178
22 Ø x 50 mm
15-179
22 Ø x 100 mm
15-180
22 Ø x 140 mm
15-181
22 Ø x 200 mm

Kelly Intestinal Rectal Speculum



Barr-Shilford Intestinal Rectal Speculum
15-182



Vernon-David Intestinal Rectal Speculum
with thumb grip handle
15-183 short handle
15-184 long (standard) handle



Bensaude Intestinal Rectal Speculum
15-185 19 Ø x 70 mm
15-186 22 Ø x 70 mm



Brinkerhoff Intestinal Rectal Speculum
15-187 smal 89 x 25mm tapers to 13mm
15-188 medium 101 x 25mm tapers to 15mm
15-189 large 120 x 31mm tapers to 19mm

Fansler Operating Intestinal Rectal Speculum

with slotted / extra long handle standard

- 15-190 25 mm x 65 mm
- 15-191 29 mm x 65 mm
- 15-192 38 mm x 70 mm

with slotted tube / short handle
 15-193 29 mm x 60 mm
 15-194 operating speculum

Chelsea-Eaton Intestinal Rectal Speculum

solid handle
 15-195 small
 15-196 large
 with light connection available

Hirschman Anoscope Intestinal Rectal Speculum

15-197 small
 57 x 14mm inside diameter
 15-198 medium
 52 x 17mm inside diameter
 15-199 large
 89 x 22mm inside diameter

Buie Hirschman Anoscope Intestinal Rectal Speculum

15-200 small
 57 x 14mm inside diameter
 15-201 medium
 95 x 19mm inside diameter
 15-202 large
 98 x 25mm inside diameter

Ives-fansler Anoscope Intestinal Rectal Speculum

with hard rubber obturator / fenestrated handle
 15-203 22 mm x 85 mm



Long Chrome Handle Intestinal Rectal Speculum
 15-204 81 x 29mm

Morgen Proctoscope Intestinal Rectal Speculum

with light connection
 15-205 17mm
 15-206 20mm
 15-207 24mm

Kelly Proctoscope Intestinal Rectal Speculum

chrome plated
 15-208 22mm x 50 mm
 15-209 22mm x 100 mm
 15-210 22mm x 145 mm



Hemorrhoidal Ligator-Suction
15-211

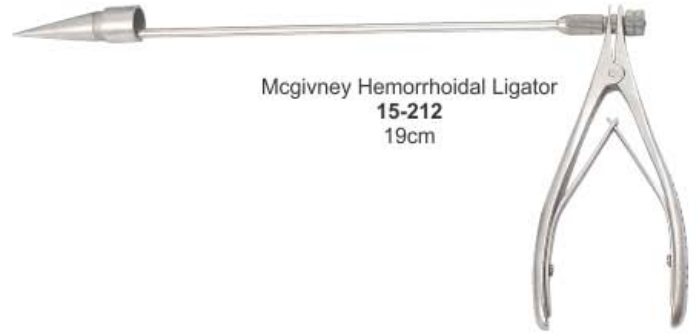

McGivney Hemorrhoidal Ligator
15-212
19cm



15-213
Rudd Hemorrhoidal Ligator with loading cone 12mmØ
31.5 cm Str.

15-214
Rudd Hemorrhoidal Ligator with loading cone 12mmØ
31.5 cm Cvd.

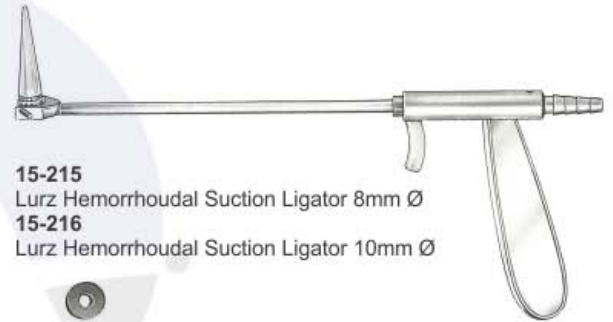

15-215
Lurz Hemorrhoidal Suction Ligator 8mm Ø
15-216
Lurz Hemorrhoidal Suction Ligator 10mm Ø

15-217
Ligator rubber rings
in package of 100 pieces



15-219
McGivney Hemorrhoidal Ligator
With Offset Handle 18 cm
Working Length.



15-218
McGivney Hemorrhoid Grasping Forceps
19 cm angled shank.



McGivney Hemorrhoidal Ligator
Complete Set
15-220

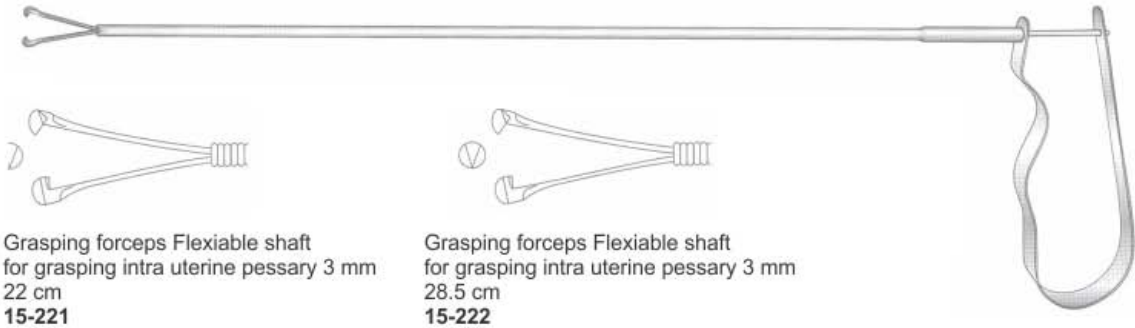

Grasping forceps Flexiable shaft
for grasping intra uterine pessary 3 mm
22 cm
15-221

Grasping forceps Flexiable shaft
for grasping intra uterine pessary 3 mm
28.5 cm
15-222



Barren McGivney Hemorrhoidal Ligator forceps with stainless steel con
15-223
Barren McGivney Hemorrhoidal Ligator forceps with telon cone
15-224

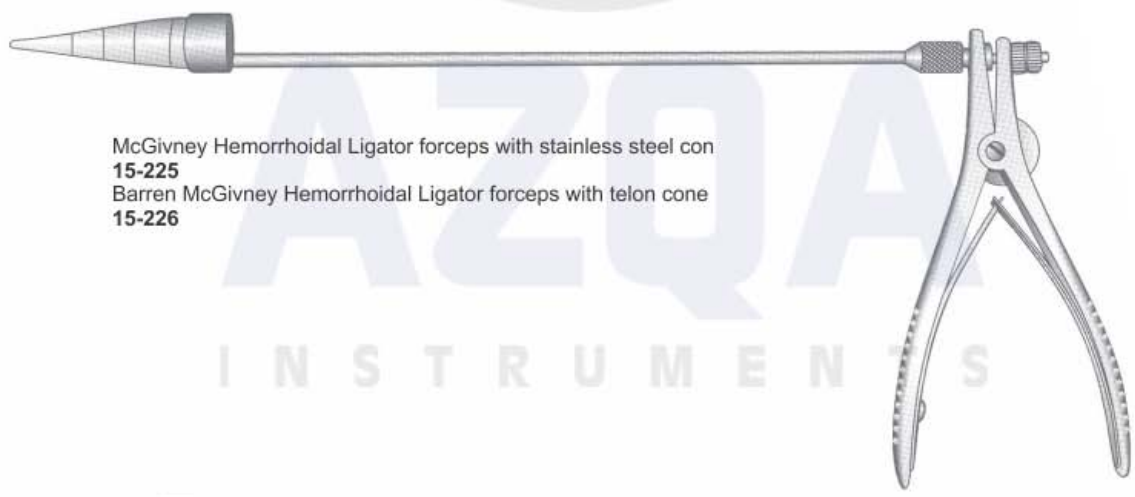

McGivney Hemorrhoidal Ligator forceps with stainless steel con
15-225
Barren McGivney Hemorrhoidal Ligator forceps with telon cone
15-226

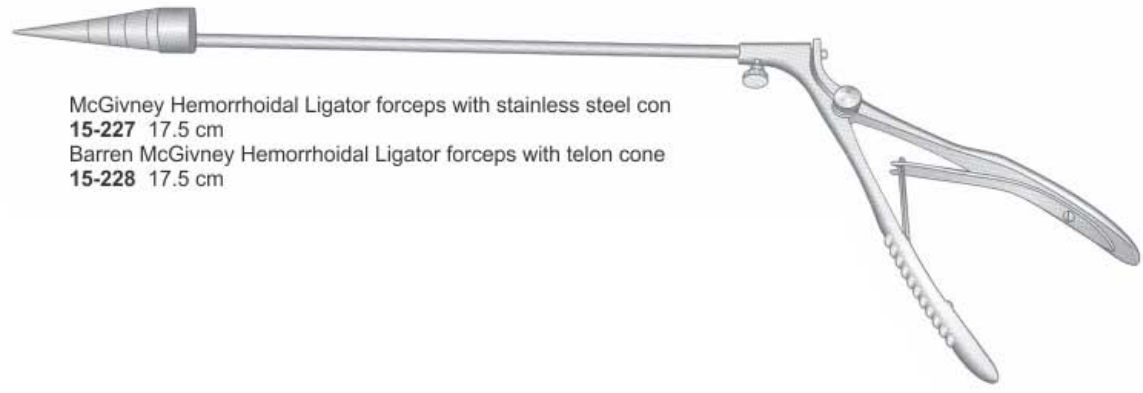

McGivney Hemorrhoidal Ligator forceps with stainless steel con
15-227 17.5 cm
Barren McGivney Hemorrhoidal Ligator forceps with telon cone
15-228 17.5 cm

UROLOGY INSTRUMENTS





Randall Kidney Stone Clamps Forceps

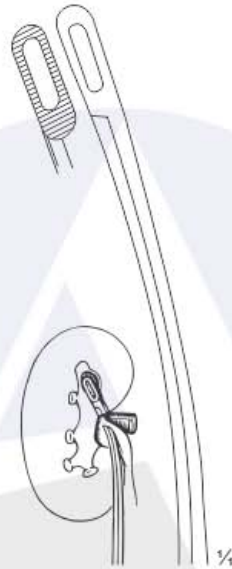

16-001
23 cm
quarter curved

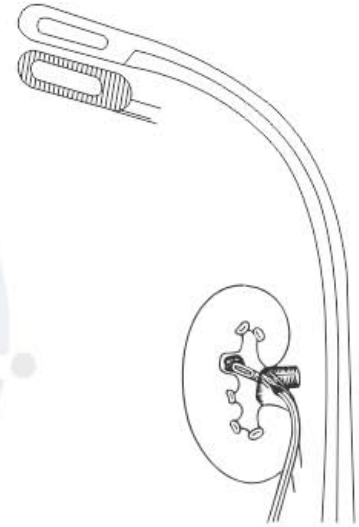

16-002
23 cm
half curved

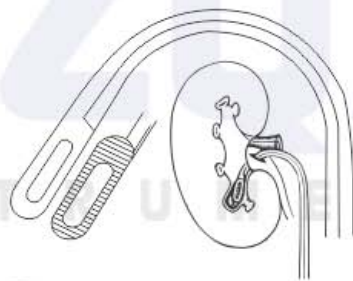

16-003
23 cm
full curved

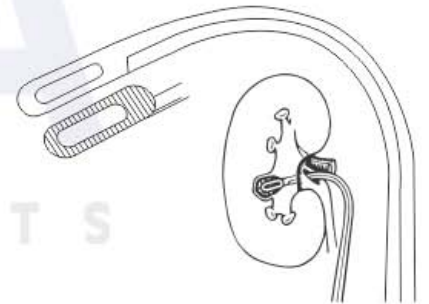

16-004
23 cm
three quarter curved



Randall
Kidney Stone Forceps



Heiming
Kidney Stone Forceps

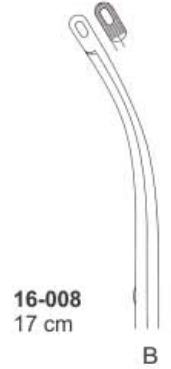

Elsasser
Nephrostomy Forceps



16-009
21 cm
Fig. 1

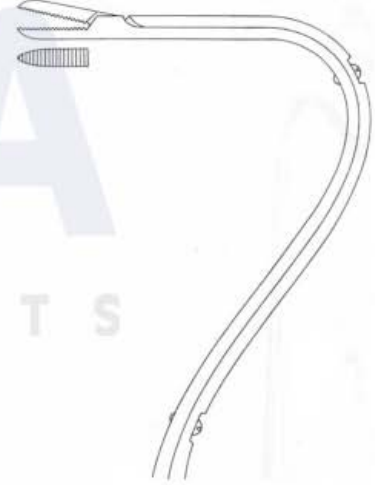

16-010
21 cm
Fig. 2



Dartigues Uterine Elevating Forceps
16-011 27 cm



Collin Kidney Elevating Stone Clamps Forceps
16-012 28.5 cm



Hulka-Kenwick Uterine Elevating & Manipulating Forceps
16-013 27 cm



Sommer Kidney Elevating Stone Clamps Forceps
16-014 23.5 cm



Strassmann Kidney Elevating Stone Clamps Forceps
16-015 26 cm



Collin Kidney Elevating Stone Clamps Forceps
16-016 26.5 cm



Collin Kidney Elevating Stone Clamps Forceps
16-017 26 cm



Blake Gall Stone Forceps
16-018 20 cm
Straight



Blake Gall Stone Forceps
16-019 21 cm
Curved



Mayo-Blake Gall Stone Forceps
16-020 20 cm
Straight



Mayo-Blake Gall Stone Forceps
16-021 20 cm
Curved



16-022
26 cm

16-023
26 cm

Uro-Tangential Gall Stone Forceps



Mixer Gall Stone Forceps
16-024 22 cm



Desjardins Gall Stone Forceps
16-025 23 cm



Desjardins Gall Stone Forceps
16-026 23 cm

Kapselfasszangen, Fadenführungszange | Pincés pour saisir les capsules, Pince porte-fil
Pinzas capsulares, Pinza porta ligaduras | Pinze per afferrare capsule, Pinza porta-filo



16-027
24 cm

**Harris Capsule Ligature
Angled Suture Forceps**

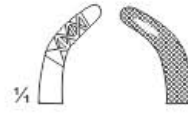

16-028
29 cm

**Johnson Prostatic
Needle Holder**



16-029
23 cm

Stratte Needle Holder



**Millin Prostatectomy
Forceps**
16-030 24 cm



**Millin Prostatectomy
Forceps**
16-031 23 cm



Millin Vulsellum Forceps
16-032 23 cm

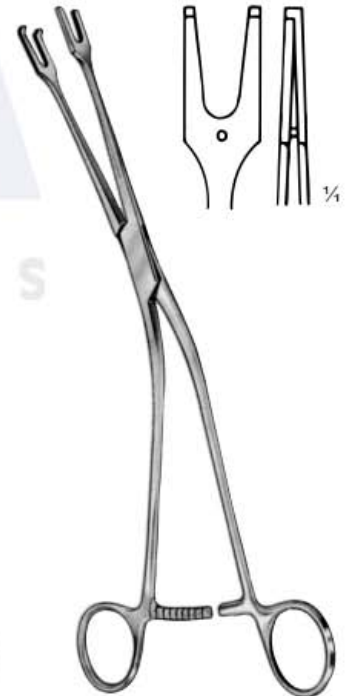

**Millin Ligature Carrying
Forceps Angular**
16-033 23 cm

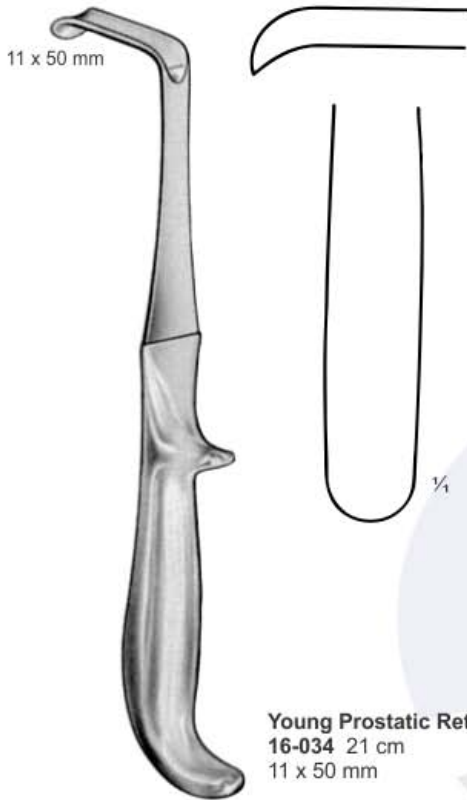

Young Prostatic Retractor
16-034 21 cm
11 x 50 mm



Young Prostatic Retractor
16-035 22 cm
38 x 64 mm

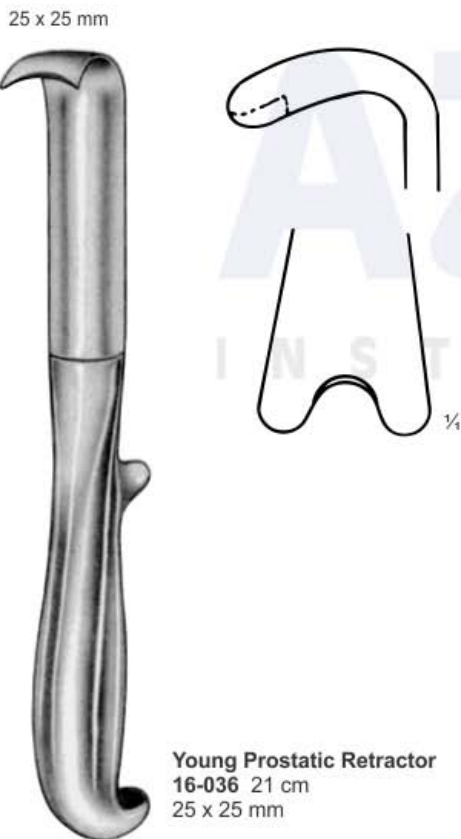
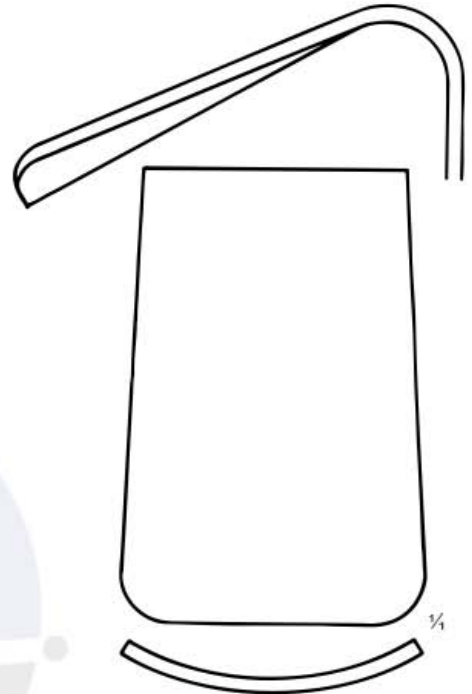

Young Prostatic Retractor
16-036 21 cm
25 x 25 mm



Young Prostatic Retractor
16-037 22 cm
39 x 35 mm

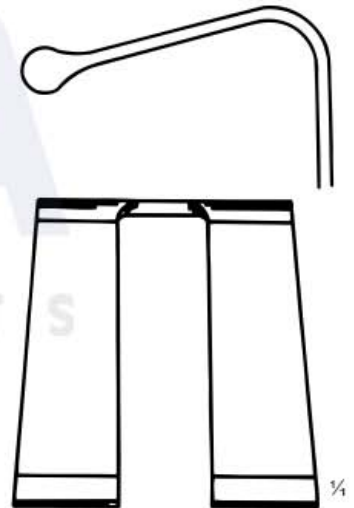

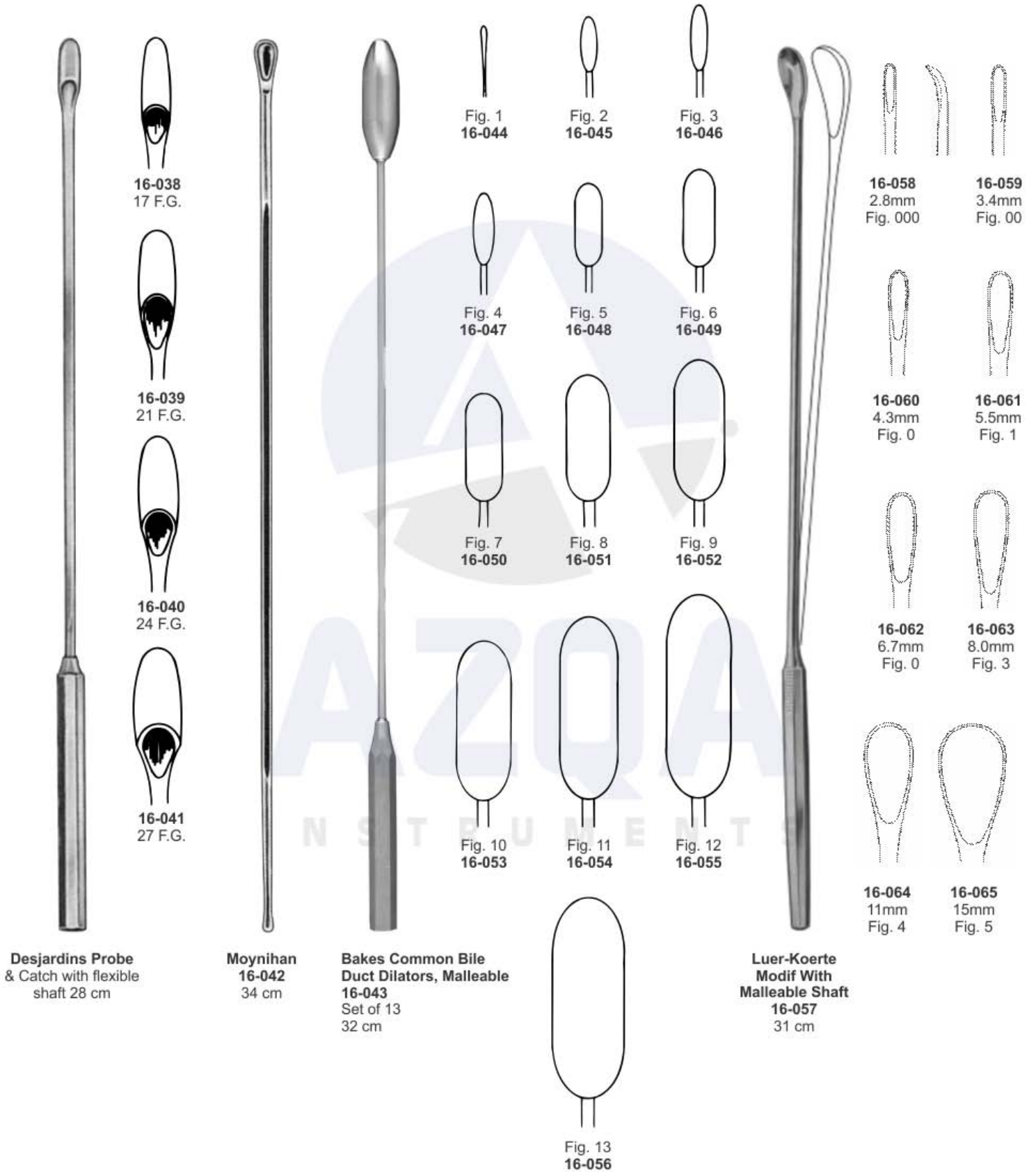



Catheter
16-066
15 cm
No. 6-16



Catheters 29 cm
Male Catheters chart., Metal
French
16-067 8
16-068 10
16-069 12
16-070 14
16-071 16
16-072 18
16-073 20



Lister Bougies
16-074
27 cm
00 / 1 to 15 / 18
set of 17



Clutton Bougies
16-075 27 cm
06 / 10 FG to 28 / 32
set of 12



Van Buren
Urethral Sound
16-076
A to O
Set of 15

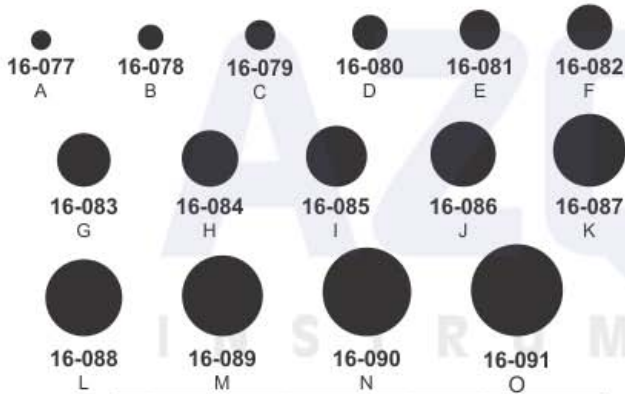
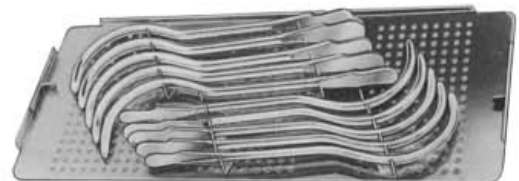
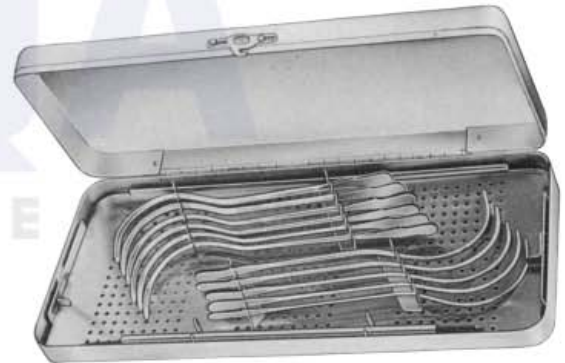

Fig.	Item	Description	Inches	Dia. Charr
A	16-077	28 cm	11"	8 French
B	16-078	28 cm	11"	10 French
C	16-079	28 cm	11"	12 French
D	16-080	28 cm	11"	14 French
E	16-081	28 cm	11"	16 French
F	16-082	28 cm	11"	18 French
G	16-083	28 cm	11"	20 French
H	16-084	28 cm	11"	22 French
I	16-085	28 cm	11"	24 French
J	16-086	28 cm	11"	26 French
K	16-087	28 cm	11"	28 French
L	16-088	28 cm	11"	30 French
M	16-089	28 cm	11"	32 French
N	16-090	28 cm	11"	34 French
O	16-091	28 cm	11"	36 French



Guyon
16-092
420 x 175 x 40 mm
Set in metal case containing:
— 21 Bougies Guyon
— 6 filliform Bougies



Dittel
22.5 cm
urethral bougies and
dilating sounds

Charr. (French)	
16-093	8
16-094	9
16-095	10
16-096	11
16-097	12
16-098	13
16-099	14
16-100	15
16-101	16
16-102	17
16-103	18
16-104	19
16-105	20
16-106	21
16-107	22
16-108	23
16-109	24
16-110	25
16-111	26
16-112	27
16-113	28
16-114	29
16-115	30



Dittel
35 cm
urethral bougies and
dilating sounds

Charr. (French)	
16-116	8
16-117	9
16-118	10
16-119	11
16-120	12
16-121	13
16-122	14
16-123	15
16-124	16
16-125	17
16-126	18
16-127	19
16-128	20
16-129	21
16-130	22
16-131	23
16-132	24
16-133	25
16-134	26
16-135	27
16-136	28
16-137	29
16-138	30



33 cm
filiform guides,
olive tip

Charr. (French)	
16-139	3
16-140	4
16-141	5
16-142	6



Guyon
16-143
25 cm
Set
urethral bougies and
dilating sounds
without filiform guides,
with thread in tip

Charr. (French)	
16-144	Ben. 24 / Charr. 12 Ben. 25
16-145	Ben. 26 / Charr. 13 Ben. 27
16-146	Ben. 28 / Charr. 14 Ben. 29
16-147	Ben. 30 / Charr. 15 Ben. 31
16-148	Ben. 32 / Charr. 16 Ben. 33
16-149	Ben. 34 / Charr. 17 Ben. 35
16-150	Ben. 36 / Charr. 18 Ben. 37
16-151	Ben. 38 / Charr. 19 Ben. 39
16-152	Ben. 40 / Charr. 20 Ben. 41
16-153	Ben. 42 / Charr. 21 Ben. 43
16-154	Ben. 44 / Charr. 22 Ben. 45
16-155	Ben. 46 / Charr. 23 Ben. 47
16-156	Ben. 48 / Charr. 24 Ben. 49
16-157	Ben. 50 / Charr. 25 Ben. 51
16-158	Ben. 52 / Charr. 26 Ben. 53
16-159	Ben. 54 / Charr. 27 Ben. 55
16-160	Ben. 56 / Charr. 28 Ben. 57
16-161	Ben. 58 / Charr. 29 Ben. 59
16-162	Ben. 60 / Charr. 30

Blasenhalsperrer, Blasenwundsperrer

Ecarteur pour le col de la vessie, Ecarteurs vésicaux

Dilatador para el cuello vesical, Separadores vesicales

Divaricatore del collo vescicale, Divaricatore vescicale



Knutson
16-163 18 cm
Urethrographie-Instruments

16-164
Spare



Mogen Circumcision Clamp
16-165



Circumcision Shield
16-166 10cm



Winkelmann Circumcision Clamps
16-167 12 mm Ø
16-168 16 mm Ø
16-169 20 mm Ø

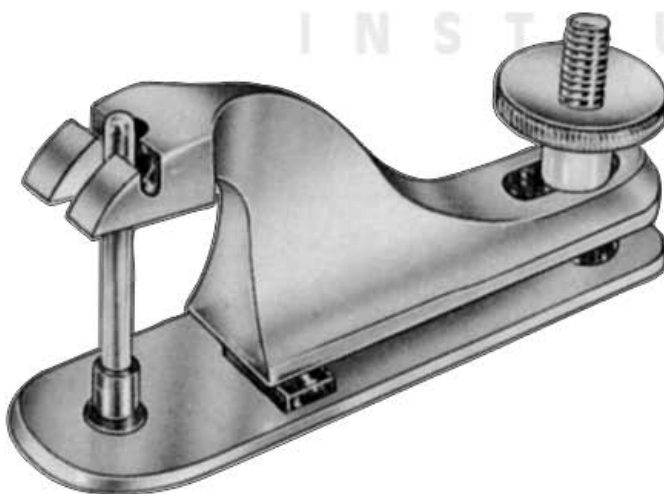

Gumco Circumcision Clamp

	mm Ø
16-170	8
16-171	11
16-172	13
16-173	16
16-174	21
16-175	26
16-176	32



Stockmann Penile Clamp
16-177 8cm



Millin Bladder Neck Spreader
16-178
28 cm



Zieser Meaeus Clamp
16-179 10cm



Strauss Penile Clamp
16-180 11cm



Thomson Walker Penile Clamp
16-181



Lewkowitz Lithotomy Forceps
16-182 26cm Str.



Lewkowitz Lithotomy Forceps
16-183 26cm Cvd



Young Lobe Holding Forceps
16-184 20cm

Blasenhalsperrer, Blasenwundsperrer

Ecarteur pour le col de la vessie, Ecarteurs vésicaux

Dilatador para el cuello vesical, Separadores vesicales

Divaricatore del collo vescicale, Divaricatore vescicale



**Legueu Bladder Spatula
16-185**



**Gosset Bladder
Retractor
16-186 160mm**



**Thomson Walker
Bladder Retractor
16-187**

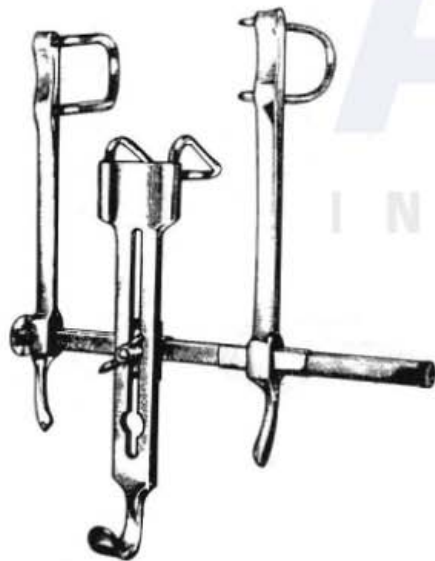

**Pantings Bladder
Retractor
16-188**



**Judd Masson
Bladder Retractor
16-189
w/center blade**



**Millin
16-190
Bladder Retractor**



Child Hernia Director
16-191



Key Hernia Director
16-192



Teale Hernia Director
16-193



Millin Suction Tube
16-194



Cord Hook
16-195
blunt 16cm



Gutmann Secretions Scoop
16-196 26cm



No Scalpel Vasectomy Ringed Forceps Clamps
16-197 14cm



No Scalpel Vasectomy Hemostat Forceps
16-198 14cm
smooth sharp point curved



Legueu Bladder Retractor
16-199
27cm



Kocher's Bladder Retractor
16-200 23.5 cm

**RECTUM VASECTOMY SET OF 4 PCS
16-201**



**RECTUM VASECTOMY SET OF 4 PCS
16-202**



**RECTUM VASECTOMY SET OF 2 PCS
16-203**



**RECTUM VASECTOMY SET OF 3 PCS
16-204**



**RECTUM VASECTOMY SET OF 4 PCS
16-205**

GYNECOLOGY/OBSTETRICS INSTRUMENTS



Dilatation and Curettage

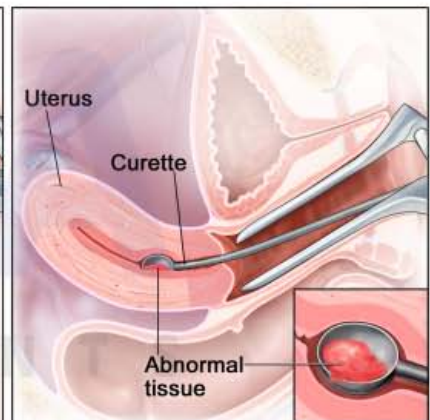
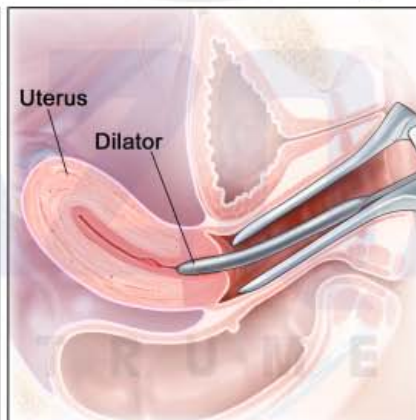
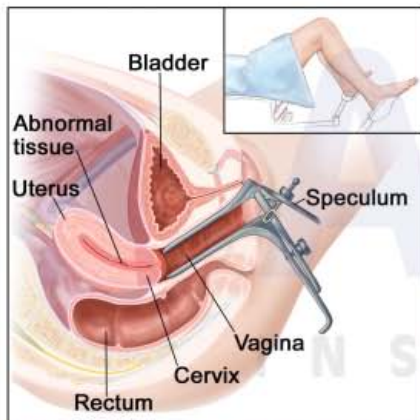



Cusco vaginal speculum
17-001 75 mm x 32 mm
17-002 85 mm x 35 mm
17-003 100 mm x 35 mm
17-004 75 mm x 17 mm
 for vierges



Cusco vaginal speculum
17-005 75 mm x 32 mm
17-006 80 mm x 35 mm
17-007 100 mm x 37 mm



Cusco vaginal speculum
17-008 80 mm x 22 mm
17-009 100 mm x 25 mm
17-010 105 mm x 27 mm
 Swiss pattern



Grave vaginal speculum
17-011 75 mm x 20 mm
17-012 95 mm x 35 mm
17-013 115 mm x 35 mm



Pederson vaginal speculum
17-014 75 mm x 13 mm
17-015 100 mm x 22 mm
17-016 120 mm x 25 mm



Winterton
17-017



Trelat vaginal speculum
17-018 85 mm x 30 mm
17-019 95 mm x 35 mm
17-020 115 mm x 43 mm



Vaginal Speculum Cusco
17-021 Extra Small
17-022 Small
17-023 Medium
17-024 Medium Extra long
17-025 Large



Semm vaginal speculum
17-026 90 mm x 14 / 18 mm
17-027 100 mm x 17 / 20 mm
17-028 110 mm x 25 / 30 mm

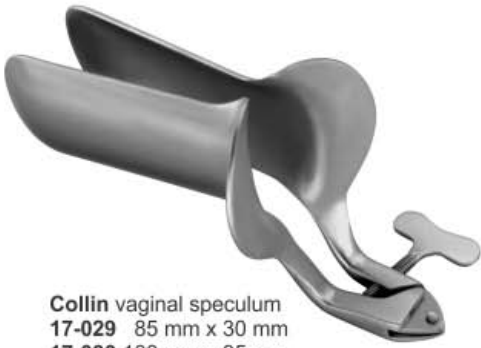

Collin vaginal speculum
17-029 85 mm x 30 mm
17-030 100 mm x 35 mm
17-031 110 mm x 40 mm

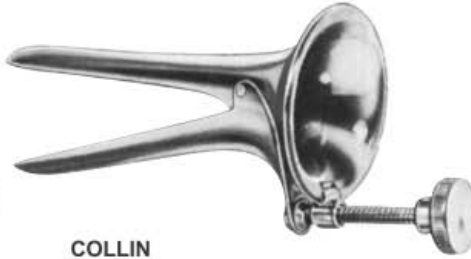

COLLIN
17-032
55 x 10 mm

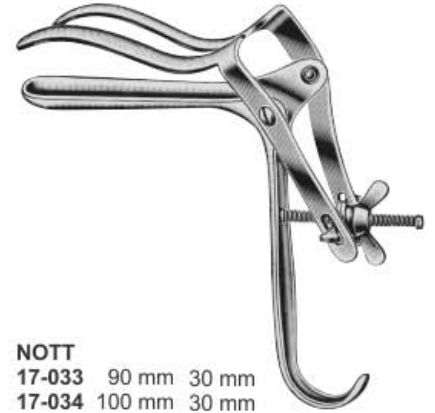

NOTT
17-033 90 mm 30 mm
17-034 100 mm 30 mm



DE VILBISS
17-035
4 x 27 mm
102 mm x 32 mm
Medium



SEYFFERT
17-036 100 x 24 mm
17-037 110 x 32 mm
23 cm, 9"



CUSCO
17-038 75 x 32 mm
17-039 85 x 35 mm
17-040 100 x 35 mm



CUSCO
17-041 75 x 17 mm



CUSCO
17-042 90 x 22 mm
17-043 100 x 25 mm
17-044 105 x 27 mm



GRAVES
Virgin Speculaums
Color Coated, Straight
17-045 20mm x 75mm, Small
17-046 35mm x 95mm, Medium
17-047 35mm x 115mm, Large



Graves Vaginal Speculum Leep / Lietz
17-048 Small
17-049 Medium
17-050 Large
17-051 X-large



Pederson Vaginal Speculum Leep / Lietz
17-052 Small
17-053 Medium
17-054 Large
17-055 X-Large



PEDERSON
Virgin Speculaums
Color Coated
17-056 17mm x 100mm, Narrow
17-057 13mm x 75mm, Small
17-058 22mm x 100mm, Medium
17-059 25mm x 120mm, Large



NEW PORT
17-060
25 cm

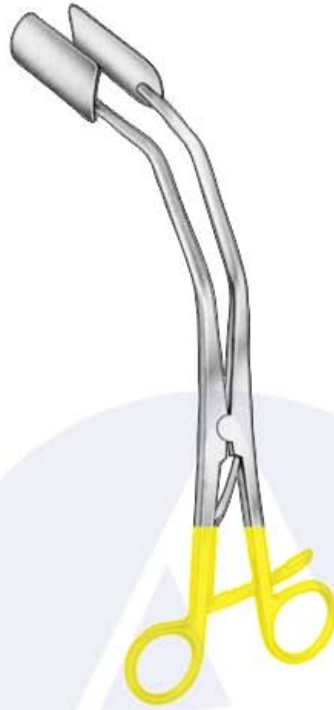

**Lateral Vaginal
Retractor**
17-061
21 cm

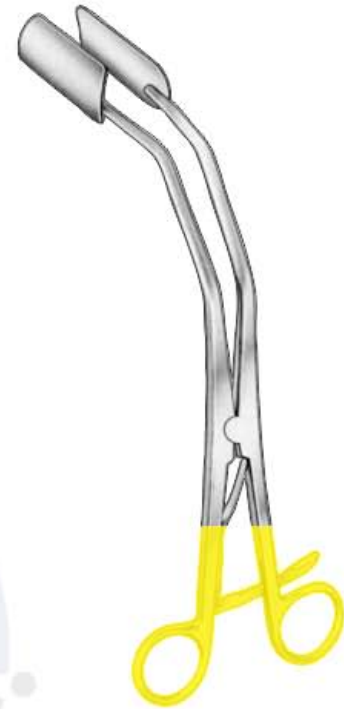

**Lateral Vaginal Retractor
Blue Coated Leep / Lietz**
17-062 21 cm



Side Wall Retractors
17-063 4-Sided Pederson Speculum, Medium
17-064 4-Sided Pederson Speculum, Large
Redundant Wall Retractor, 3.5 in. x .75 in. blades
Lateral Wall Retractor, Closed Shanks, 2.25 in. blades
Lateral Wall Retractor, Open Shanks, 2.5 in. blades



Lateral Vaginal Retractor
Blue Coated
17-065 26cm



**McGee Lateral
Vaginal Retractor
With Ratchet Handle**
17-066 20cm



**Kogan Speculum
17-067**
24 cm
with scale-ratchet
and fixation screw



**Kogan Speculum
17-068**
24 cm



**Kogan - Modif.
Speculum**
28 cm
17-069
x=4 mm y=8mm
17-070
x=2 mm y=4mm



**Kogan Endocervical Spatula
17-071**
Ratchet, Standard Tips, 28cm
Ratchet, Narrow Tips, 28cm
Set Screw, Standard Tips, 28cm
Set Screw, Narrow Tips, 28cm



**RAMATHIBODI
17-072**
27.5 cm
Uterine Manipulator



**RAMATHIBODI
17-073**
25 cm
Tubal hook



Kristeller Speculum
17-074 70 mm x 27 mm
17-075 80 mm x 30 mm
17-076 90 mm x 36 mm
17-077 110 mm x 27 mm
17-078 110 mm x 30 mm
17-079 110 mm x 36 mm



Kristeller Retractor
17-080 75 mm x 23 mm
17-081 85 mm x 26 mm
17-082 100 mm x 32 mm
17-083 115 mm x 23 mm
17-084 115 mm x 26 mm
17-085 115 mm x 32 mm

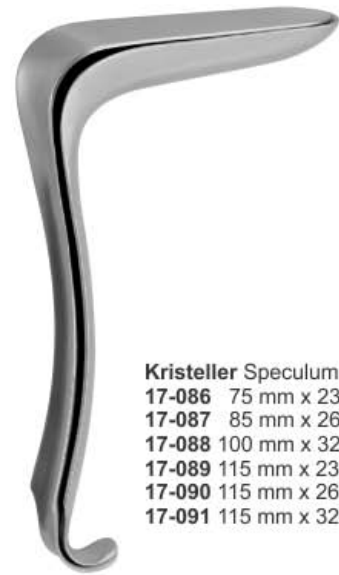

Kristeller Speculum & Retractor
17-086 75 mm x 23 mm
17-087 85 mm x 26 mm
17-088 100 mm x 32 mm
17-089 115 mm x 23 mm
17-090 115 mm x 26 mm
17-091 115 mm x 32 mm



Kristeller Speculum
17-092 105 mm x 18 mm
17-093 105 mm x 21 mm
 Speculum tapered, for virgins



Kristeller Retractor
17-094 110 mm x 14 mm
17-095 115 mm x 17 mm



Kristeller Speculum & Retractor
17-096 110 mm x 14 mm
17-097 115 mm x 17 mm

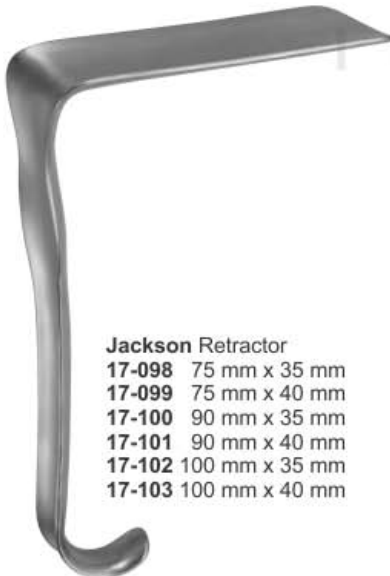

Jackson Retractor
17-098 75 mm x 35 mm
17-099 75 mm x 40 mm
17-100 90 mm x 35 mm
17-101 90 mm x 40 mm
17-102 100 mm x 35 mm
17-103 100 mm x 40 mm



Sims Speculum & Retractor
17-104 70 mm x 25 mm / 30 mm
17-105 75 mm x 30 mm / 35 mm
17-106 80 mm x 35 mm / 40 mm

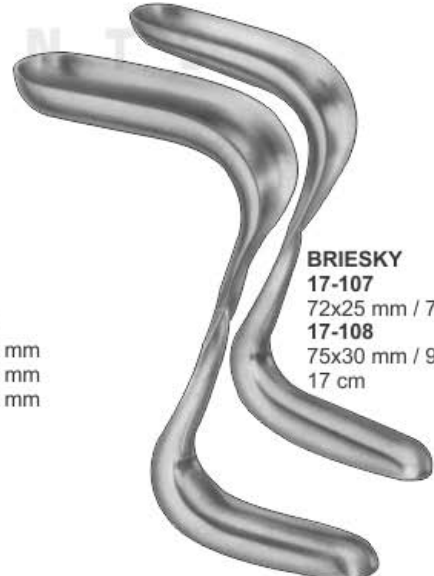

BRIESKY
17-107
 72x25 mm / 77x30 mm
17-108
 75x30 mm / 92x38 mm
 17 cm



Kallmorgen Speculum
17-109 70 mm x 40 mm
17-110 90 mm x 40 mm



Kallmorgen & Retractor
17-111 70 mm x 33 mm
17-112 90 mm x 33 mm



Kallmorgen Speculum & Retractor
17-113 70 mm x 33 mm
17-114 90 mm x 33 mm



MATHIEU Vaginal Speculum
17-115
Set 100x13mm-23mm
17-116
95x16mm-26mm
17-117
95x26mm-30 mm
21 cm



MATHIEU Vaginal Retractor
17-118
Set 100x17mm-30mm
17-119
100x11mm-20mm
17-120
100x14mm-26mm
22 cm



Doyen Vaginal Speculum
22 cm



Slightly Concave

- 17-121 60 x 35 mm
- 17-122 90 x 35 mm
- 17-123 120 x 35 mm
- 17-124 60 x 45 mm
- 17-125 90 x 45 mm
- 17-126 120 x 45 mm
- 17-127 160 x 45 mm
- 17-128 60 x 60 mm
- 17-129 90 x 60 mm
- 17-130 120 x 60 mm
- 17-131 160 x 60 mm



Landon Vaginal Retractor
17-132
Blade 9 cm
Deep 2.5 cm wide.



BRAUN
17-133
18 cm



BRAUN
17-134
18 cm



17-135
Handle with cold light carrier for upper blades
28 cm



17-136
115 x 22 mm
17-137
115 x 26 mm

SIMON
115 x 22 mm
27.5 cm



95 x 17-26 mm

**MATHIEU
17-138**
For children and
virgins fitting
21 cm



95 x 17 - 30 mm

**MATHIEU
17-139**
For children
and virgins
21 cm



LANDON
Vaginal Retractor
17-140
(2.5cm x 9cm x 20cm)
Colour coated



**Wertheim
Retractor
17-141**
(3cm x 9.5cm
x 27.5cm)



**Landau
Speculum
29 cm
17-142**
100x 28 mm
17-143
100x 38 mm



**Breisky Speculum
30 cm
17-144**
130x 20 mm
17-145
130 x 25 mm
17-146
130 x 30 mm
17-147
130 x 35 mm
17-148
130 x 40 mm
Vienna pattern



**Breisky Speculum
30 cm
17-149**
100 x 20 mm
17-150
100 x 25 mm
17-151
100 x 30 mm
17-152
100 x 35 mm
17-153
100 x 40 mm



**Breisky Speculum
35 cm
17-154**
160 x 40 mm
17-155
180 x 40 mm



Veronikis Vaginal
Retractors
17-156
(2.5 cm) blade width,
30cm length



Veronikis Vaginal
Retractors
17-157
(2.5 cm) blade width,
34 cm length



Veronikis Vaginal
Retractors
17-158
(3.8 cm) blade width,
30cm. length



Veronikis Vaginal
Retractors
17-159
(2.5 cm) Tapered blade,
30cm. length



Scherback Speculum
17-160
 Set consisting of:
 handle weight 5 blades



17-161
 80 x 30 mm



17-162
 85 x 35 mm



17-163
 85 x 40 mm



17-164
 55 x 40 - 60 mm



17-165
 70 x 45 - 70 mm



Scherback Speculum
17-166
 Set consisting of:
 2 handle, 8 blades



17-167
 80 x 30 mm



17-171
 65 x 30 mm



17-168
 85 x 33 mm



17-172
 75 x 35 mm

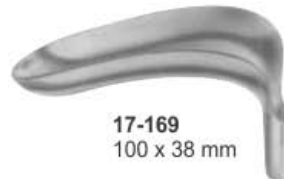

17-169
 100 x 38 mm



17-173
 85 x 35 mm



17-170
 110 x 42 mm



17-174
 95 x 35 mm

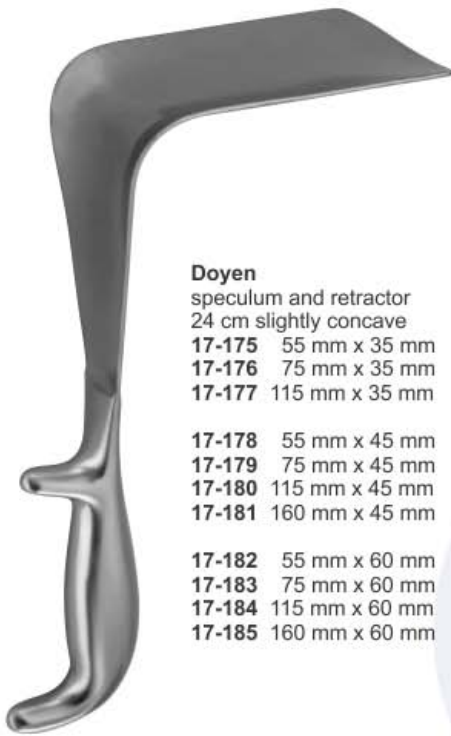

Doyen
speculum and retractor
24 cm slightly concave
17-175 55 mm x 35 mm
17-176 75 mm x 35 mm
17-177 115 mm x 35 mm

17-178 55 mm x 45 mm
17-179 75 mm x 45 mm
17-180 115 mm x 45 mm
17-181 160 mm x 45 mm

17-182 55 mm x 60 mm
17-183 75 mm x 60 mm
17-184 115 mm x 60 mm
17-185 160 mm x 60 mm



Doyen
speculum and retractor
24 cm medium concave
17-186 55 mm x 35 mm
17-187 75 mm x 35 mm
17-188 115 mm x 35 mm

17-189 55 mm x 45 mm
17-190 75 mm x 45 mm
17-191 115 mm x 45 mm

17-192 55 mm x 60 mm
17-193 75 mm x 60 mm
17-194 115 mm x 60 mm



DOYEN
Speculum & Retractor
23.5 cm

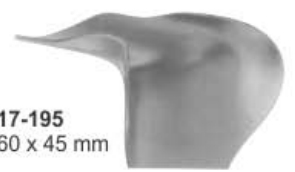

17-195
60 x 45 mm



17-196
90 x 45 mm



17-197
112 x 45 mm



**Garrigue Weighted
Vaginal Speculum**
17-198 4.0 cm x 8.0 cm
Weight 2 lbs



**Henrotin Weighted
Vaginal Speculum**
17-199 3.8 cm x 9.0 cm
Weight 3 lbs.



AUVARD,
speculum & retractor
17-200
80 x 38 mm - 28 mm
1,530 kg
with fixed weight
23 cm



AUVARD
speculum & retractor
17-201 75 x 42 mm
17-202 80- x 43 mm
(40 mm)
17-203 105 x 43 mm
(40 mm)
with detachable weight
23 cm



WEISSBARTH
speculum & retractor
17-204 80 x 28 mm
17-205 85 x 42 mm
21 cm

Scheidenspekulum
Spéculum vaginal

Espéculo vaginal
Speculum vaginale



AUVARD
17-206
65 x 38 mm - 28 mm
1,530 kg
with fixed weight
23 cm



MARTIN
17-207
with hook shaped
handle for hanging
in weights
27 cm



STEINER SPECULUM
Ideal for deep vaginal surgery.
Blades may be ordered from
4" to 7", 5.5" is normal length.

17-208
1.1 Kg / 2.5 lb:
14 cm x 3 cm



HARDY-DUDDY SPECULUM
It will not fall out. Design places the 3.5 lbs
weight at a right angle to the shaft of the
speculum, preventing expulsion. Many
blade options are available.

17-209
Hardy-Duddy Speculum,
3.5 lbs., 120 mm x 35 mm
cupped blade



AUVARD SPECULUM
An assortment of weighted
Auvard specula is available.

17-210
1.1 Kg / 2.5 lb:
8.5 cm x 4 cm
17-211
1.1 Kg / 2.5 lb:
10 cm x 4.5 cm



**NICHOLS WEIGHTED
SPECULUM**
Permits retraction of posterior
vaginal wall, while providing
suction and measurement of
fluids from the surgical site.

17-212
Nichols Vaginal Weighted Speculum
with Suction, 2.5 lbs. 7cm x 3.8cm

Vaginal Retraktoren
Écarteurs vaginaux

Retractoras vaginales
Divaricatori vaginali



**O'Sullivan - O'Connor
Vaginal Retractor**
17-213 Set of 3 Complete



17-214
45 x 17 mm



17-215
90 x 45 mm



17-216
90 x 37 mm



Abdominal Retractor
17-217 9 cm wide
17-218 10 cm wide
17-219 11.5 cm wide



Friedmann Retractor
17-220
10 cm



COMYN BERKELEY
Vulva Self Retaining



17-221
15.5cm



DOYEN
Supra Hollow Handle
17-222 7.5mm x 28cm
17-223 9mm x 28cm
17-224 10mm x 28cm
17-225 11.5mm x 28cm



DOYEN POZZI
Retractor
17-226 4.5mm x 5mm x 25.5cm
17-227 4.5mm x 9mm x 25.5cm
17-228 4.5mm x 11.5mm x 25.5cm

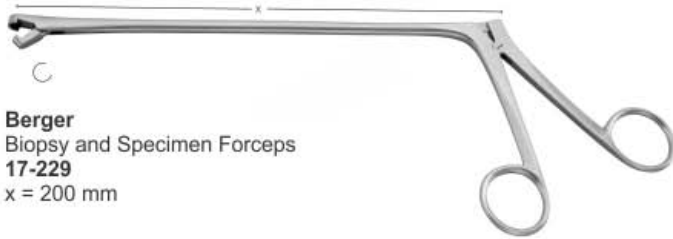

Berger
Biopsy and Specimen Forceps
17-229
x = 200 mm

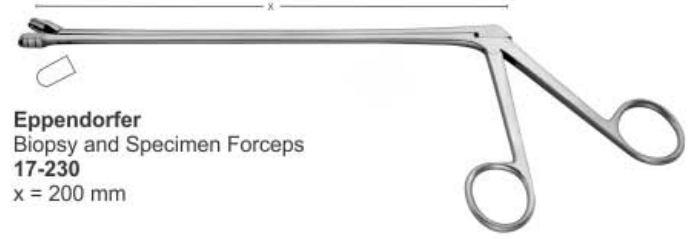

Eppendorfer
Biopsy and Specimen Forceps
17-230
x = 200 mm

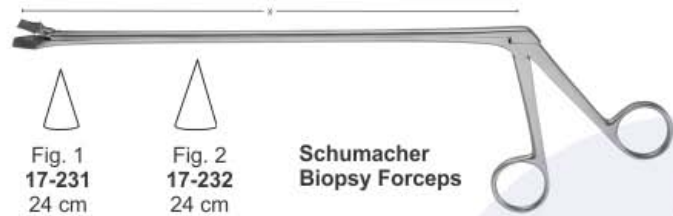

Fig. 1
17-231
24 cm

Fig. 2
17-232
24 cm

Schumacher
Biopsy Forceps



Kevorkian
Biopsy and Specimen Forceps
17-233
x = 245 mm

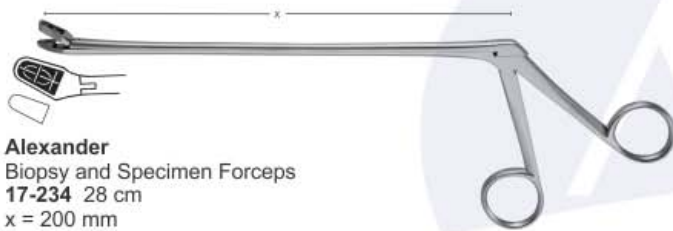

Alexander
Biopsy and Specimen Forceps
17-234 28 cm
x = 200 mm

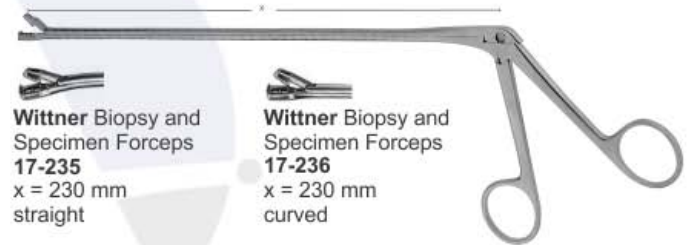

Wittner Biopsy and Specimen Forceps
17-235
x = 230 mm
straight

Wittner Biopsy and Specimen Forceps
17-236
x = 230 mm
curved



Schumacher
Biopsy and Specimen Forceps
17-237
x = 23 cm
complete

17-238
x = 23 cm
tip



Tischler - Morgan
Biopsy and Specimen Forceps
USA Modell
17-239
x = 200 mm

17-240
x = 250 mm

Tischler - Morgan
Biopsy and Specimen Forceps
17-241
x = 200 mm

17-242
x = 250 mm

Instruments as illustrated,
but without locking screw.

USA Modell



Mini - Tischler
Biopsy and Specimen Forceps
17-243
x = 200 mm

17-244
x = 250 mm

Mini - Tischler
Biopsy and Specimen Forceps
17-245
x = 200 mm

17-246
x = 250 mm

Instruments as illustrated,
but without locking screw.



Wittner Biopsy Forceps
17-247
23cm
Shaft Straight

Wittner Biopsy Forceps
17-248
23cm
Shaft Angled



Schumacher Biopsy Forceps
17-249
Small Jaw 24cm Shaft

Schumacher Biopsy Forceps
17-250
Large Jaw 24cm Shaft



Tischler Baby Biopsy Forceps
17-251
21.5cm Shaft

Probeexzisionszangen

Pinzas saca-bocados para biopsia

Pinces emporte-pièces à biopsie

Pinze taglianti per biopsia

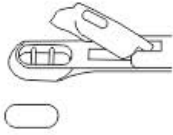

Tischler Biopsy Forceps
17-252
21.5cm Shaft



Burke Biopsy Forceps
17-253
21.5cm Shaft

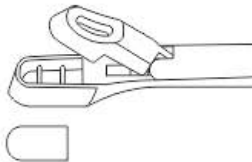

Eppendorf Biopsy Forceps
17-254
20cm Shaft



Kevorkian Young Biopsy Forceps
17-255
25.5cm Shaft



Leechwilkinson Biopsy Forceps
17-256
20cm Shaft Round





Uni - Tischler
Biopsy and
Specimen Forceps
17-258
3 x 7 mm
Straight, Tip only



Uni - Tischler
Biopsy and
Specimen Forceps
17-259
3 x 7 mm
up, Tip only



Uni - Tischler
Biopsy and
Specimen Forceps
17-260
3 x 7 mm
down, Tip only

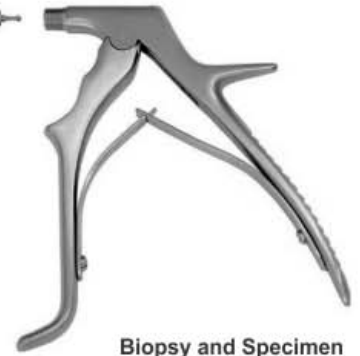

**Biopsy and Specimen
Forceps Handle only
17-257**



Uni - Townsend
Biopsy and
Specimen Forceps
17-261
2.3 x 4 mm
straight, Tip only



Uni - Townsend
Biopsy and
Specimen Forceps
17-262
2.3 x 4 mm
up, Tip only



Uni - Townsend
Biopsy and
Specimen Forceps
17-263
2.3 x 4 mm
down, Tip only



Uni - Kevorkian
Biopsy and
Specimen Forceps
17-264
3 x 9 mm
Tip only



Uni - Oval
Biopsy and
Specimen Forceps
17-265
3 x 5 mm
Tip only



Uni - Burke
Biopsy and
Specimen Forceps
17-266
3 x 5 mm
Tip only



Uni - Tischler
Biopsy and
Specimen Forceps
17-268
3 x 7 mm
Straight, Tip only



Uni - Tischler
Biopsy and
Specimen Forceps
17-269
3 x 7 mm
up, Tip only



Uni - Tischler
Biopsy and
Specimen Forceps
17-270
3 x 7 mm
down, Tip only



**Biopsy and Specimen
Forceps Handle only
17-267**



Uni - Townsend
Biopsy and
Specimen Forceps
17-271
2.3 x 4 mm
straight, Tip only



Uni - Townsend
Biopsy and
Specimen Forceps
17-272
2.3 x 4 mm
up, Tip only



Uni - Townsend
Biopsy and
Specimen Forceps
17-273
2.3 x 4 mm
down, Tip only

Uni - Kevorkian
Biopsy and
Specimen Forceps
17-274
3 x 9 mm
Tip only



Uni - Oval
Biopsy and
Specimen Forceps
17-275
3 x 5 mm
Tip only



Uni - Burke
Biopsy and
Specimen Forceps
17-276
3 x 5 mm
Tip only

Pólypenfasszange, Darm-anastomosenklemmen

Pince Pour Saisir Polypes, Pincés-clamps Pour Anastomose Intestinale

Pinza Para Coger Pólipos, Clamps Para Anastomosis Intestinales

Pinze Per Afferrare Polipi, Pinze Per Anastomosi Intestinali

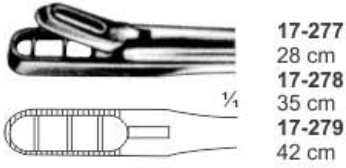
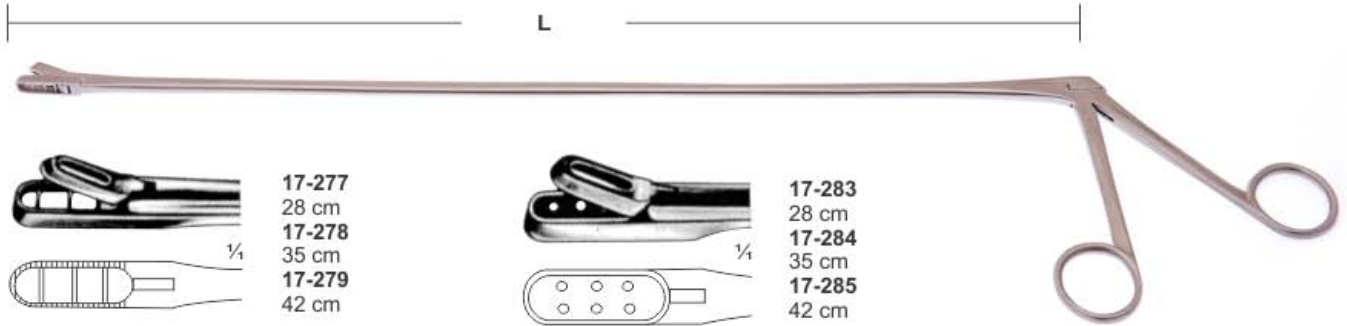

17-277
28 cm
17-278
35 cm
17-279
42 cm

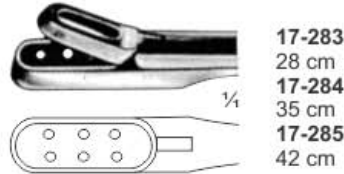

17-283
28 cm
17-284
35 cm
17-285
42 cm

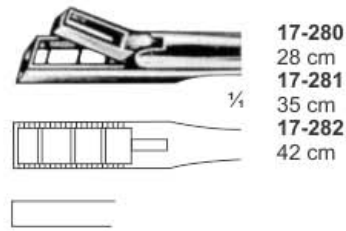

17-280
28 cm
17-281
35 cm
17-282
42 cm

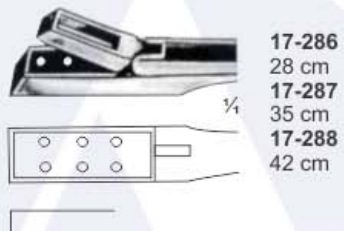

17-286
28 cm
17-287
35 cm
17-288
42 cm

YEOMANN

PILE FORCEPS

COTTON CARRIER

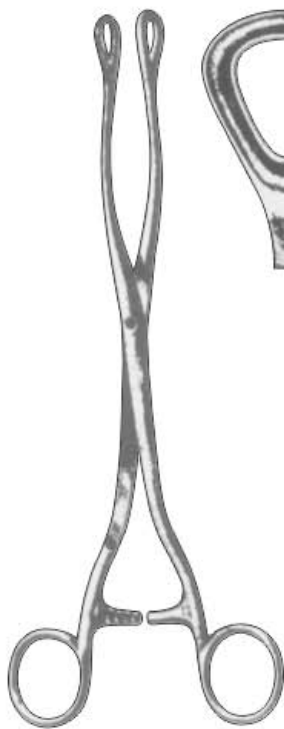

LURE
17-289
24.5cm



JARVIS
17-290
23cm



LANGENBECK
17-291
45cm



17-292
45cm

Probeexzisionszangen

Pinzas saca-bocados para biopsia

Pinces emporte-pièces à biopsie

Pinze taglianti per biopsia



**Schubert
Biopsy Forceps**
17-293 21 cm
17-294 28 cm



**Faure Uterine
Biopsy Forceps**
17-295 21 cm



**Schubert
Biopsy Forceps**
17-296 26 cm



**Gellhorn
Biopsy Forceps**
17-297 23 cm



**Thoms-Gaylor
Biopsy Forceps**
17-298 22 cm
17-299 24 cm



**Van Doren
Biopsy Forceps**
17-300 24 cm



**Schumacher
Biopsy Forceps**

Fig. 1
17-301
24 cm

Fig. 2
17-302
24 cm

Hakenzangen

Pinzas para coger el cuello del útero

Pinces pour l'abaissement du col de l'utérus

Pinze per abbassare il collo dell'utero

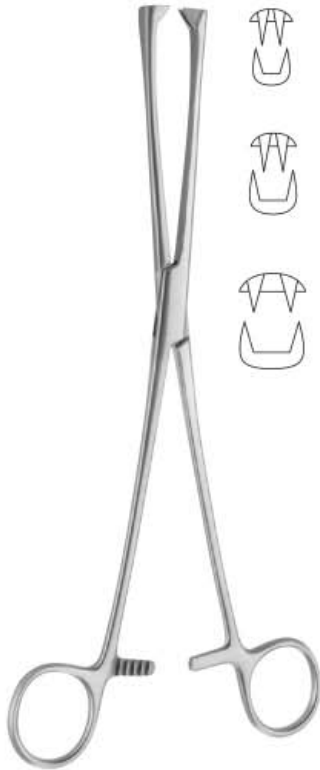

Museux Tenaculum Forceps



24 cm
17-303
8 mm
17-304
6 mm
17-305
10 mm
Straight

24 cm
17-306
8 mm
17-307
6 mm
17-308
10 mm
Curved



Jacobs Uterine Vulsellum Forceps

17-309
21 cm



17-310
21 cm

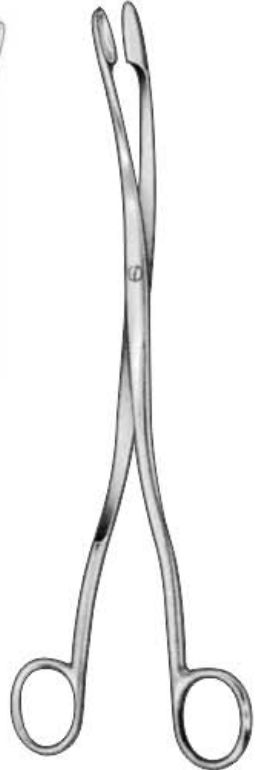

WINTER

17-311 Fig. 1
17-312 Fig. 2
17-313 Fig. 3
28 cm



Teale Tenaculum Forceps
17-314 23 cm



Pratt
Tenaculum Forceps
17-315 26 cm



Czerny
Tenaculum Forceps
17-316 20.5 cm



Schroeder Vulsellum
Tenaculum Forceps



17-317 24 cm
17-318 24 cm

Hakenzangen
Pinzas para coger el cuello del útero
Pinces pour l'abaissement du col de l'utérus
Pinze per abbassare il collo dell'utero

Pozzi Tenaculum Forceps
17-319 25.5 cm

Schroeder Tenaculum Forceps
17-320 25 cm

Duplay Tenaculum Forceps
17-321 28 cm

Iowa Tenaculum Forceps
17-322 26 cm

Skene Tenaculum Forceps
17-323 24 cm



Beacham Amniotome
17-324 26 cm

Staude - Moore Tenaculum Forceps
17-325 17 cm

Barrett Tenaculum Forceps
17-326 18 cm

Braun Tenaculum Forceps Sharp
17-327 25 cm

Schroeder-Braun Tenaculum Forceps
17-328 25 cm sharp

17-329 blunt



17-330
20 cm
1 x 2th, Angled
Screw Joint

BONNEY



17-331
20 cm
1 x 2th, Curved
Screw Joint

BONNEY-BERKLEY

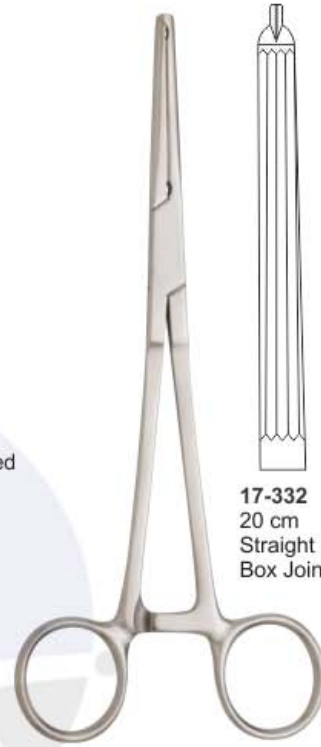

17-332
20 cm
Straight
Box Joint

GWILLIAM

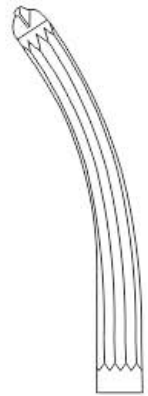

17-333
20 cm
Curved
Box Joint



17-334
20 cm
Curved
1 tooth
Box Joint

HEANEY

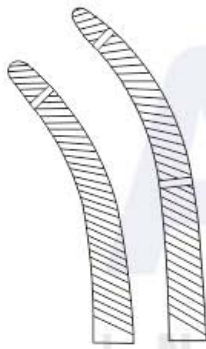

17-335
20 cm
Curved
2 Teeth
Box Joint



17-336
23 cm
Curved
Box Joint

HUNTER



17-337
20 cm
Straight
Box Joint

MAINGOT

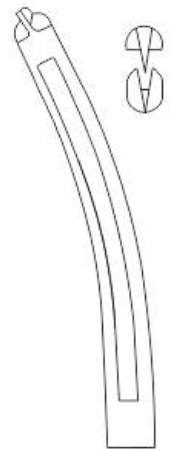

17-338
20 cm
Curved
Box Joint

Parametriumklemmen, Hysterektomieklemmen
Pincas parametrium, Pincas para hysterectomia
Pincas parametrium, Pincas à hystérectomie

Pinzas parametrium, Pinzas-clamps para hysterectomia
Pinze parametrium, Pinze per isterectomia



**Parametrium
Hysterectomy
Forceps**

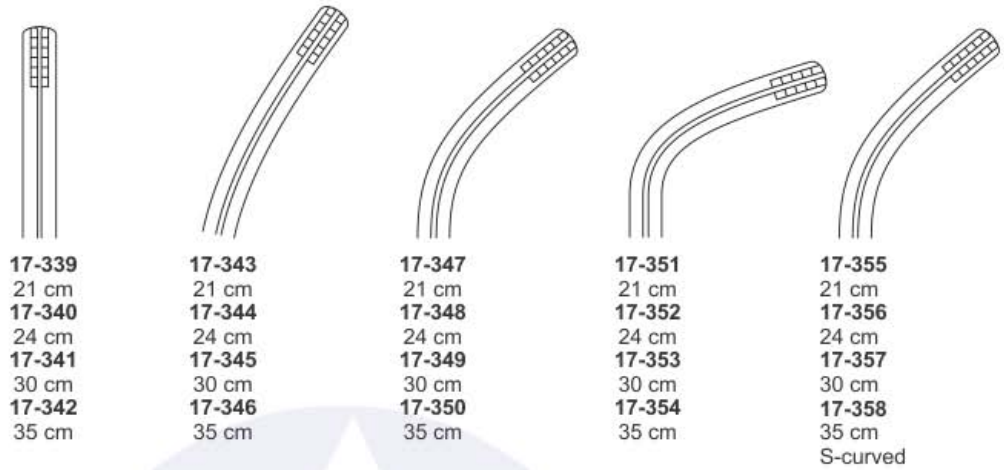

17-339
21 cm
17-340
24 cm
17-341
30 cm
17-342
35 cm

17-343
21 cm
17-344
24 cm
17-345
30 cm
17-346
35 cm

17-347
21 cm
17-348
24 cm
17-349
30 cm
17-350
35 cm

17-351
21 cm
17-352
24 cm
17-353
30 cm
17-354
35 cm

17-355
21 cm
17-356
24 cm
17-357
30 cm
17-358
35 cm
S-curved



**Rogers Parametrium
Hysterectomy Forceps**

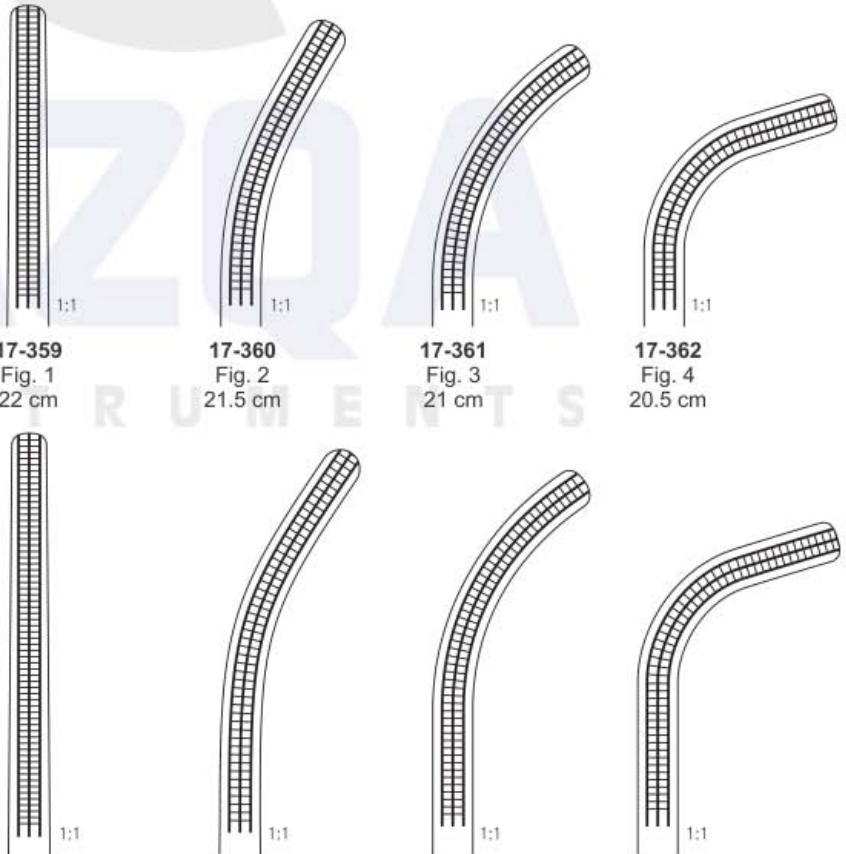

17-359
Fig. 1
22 cm

17-360
Fig. 2
21.5 cm

17-361
Fig. 3
21 cm

17-362
Fig. 4
20.5 cm

17-363
Fig. 1
25 cm

17-364
Fig. 2
25 cm

17-365
Fig. 3
24.5 cm

17-366
Fig. 4
23 cm



Hank Uterine Dilators 6 Set
17-367 Complete Set
Curved, Delicate, 11-12 Fr. to 21-22 Fr.
(3.66mm to 7.33cm)

- Hank Uterine Dilators, Double-ended**
- 17-368 11-12 Fr. (3.6mm x 4.0mm), 27.5cm
 - 17-369 13-14 Fr. (4.3mm x 4.7mm), 27.5cm
 - 17-370 15-16 Fr. (5.0mm x 5.3mm), 27.5cm
 - 17-371 17-18 Fr. (5.7mm x 6.0mm), 27.5cm
 - 17-372 19-20 Fr. (6.3mm x 6.7mm), 27.5cm
 - 17-373 21-22 Fr. (7.0mm x 7.3mm), 27.5cm



Pratt Uterine Dilators 8/Set
17-374 Complete Set
Curved, Delicate, 13-15 Fr. to 41-43 Fr., Straight

- Pratt Uterine Dilators, Double-ended**
- 17-375 13 / 15 Fr., 29.5cm
 - 17-376 17 / 19 Fr., 29.5cm
 - 17-377 21 / 23 Fr., 29.5cm
 - 17-378 25 / 27 Fr., 29.5cm
 - 17-379 29 / 31 Fr., 29.5cm
 - 17-380 33 / 35 Fr., 29.5cm
 - 17-381 37 / 39 Fr., 29.5cm
 - 17-382 41 / 43 Fr., 29.5cm



Hegar uterine dilator
17-383 3 / 4 mm - 17 / 18 mm Ø
8 Pieces per set
17-384 1 / 2 mm - 25 / 26 mm Ø
13 Pieces per set

- Hegar uterine dilator**
- 17-385 1 / 2 mm Ø
 - 17-386 3 / 4 mm Ø
 - 17-387 5 / 6 mm Ø
 - 17-388 7 / 8 mm Ø
 - 17-389 9 / 10 mm Ø
 - 17-390 11 / 12 mm Ø
 - 17-391 13 / 14 mm Ø
 - 17-392 15 / 16 mm Ø
 - 17-393 17 / 18 mm Ø
 - 17-394 19 / 20 mm Ø
 - 17-395 21 / 22 mm Ø
 - 17-396 23 / 24 mm Ø
 - 17-397 25 / 26 mm Ø
- double ended



Hegar Uterine Dilators 8 Set W/Roll
17-398 Complete Set
Curved, Delicate, 3mm to 18mm, Curved

- Hegar Uterine Dilator, Double-ended**
- 17-399 3mm & 4mm, (20cm)
 - 17-400 5mm & 6mm, (20cm)
 - 17-401 7mm & 8mm, (20cm)
 - 17-402 9mm & 10mm, (20cm)
 - 17-403 11mm & 12mm, (20cm)
 - 17-404 13mm & 14mm, (20cm)
 - 17-405 15mm & 16mm, (20cm)
 - 17-406 17mm & 18mm, (20cm)

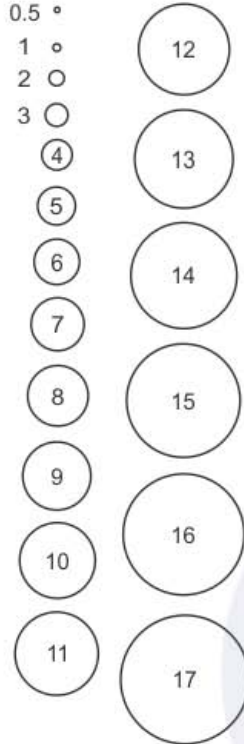

- 17-408 18.5cm 3-4-5mm
 - 17-409 18.5cm 4-5-6mm
 - 17-410 18.5cm 5-6-7mm
 - 17-411 18.5cm 6-7-8mm
 - 17-412 18.5cm 7-8-9mm
 - 17-413 18.5cm 8-9-10mm
 - 17-414 18.5cm 9-10-11mm
 - 17-415 18.5cm 10-11-12mm
 - 17-416 18.5cm 11-12-13mm
 - 17-417 18.5cm 12-13-14mm
 - 17-418 18.5cm 13-14-15mm
 - 17-419 18.5cm 14-15-16mm
 - 17-420 18.5cm 15-16-17mm
 - 17-421 18.5cm 16-17-18mm
 - 17-422 18.5cm 17-18-19mm
 - 17-423 18.5cm 18-19-20mm
- Canvas Roll

Bonney-Barker Dilators
 17-407 Set of 16 Pcs



- 17-425 27cm 9/10mm
- 17-426 27cm 11/12mm
- 17-427 27cm 13/14mm
- 17-428 27cm 15/16mm
- 17-429 27cm 17/18mm
- 17-430 27cm 19/20mm

Hank Double Ended
 17-424 Set of 6 Pcs

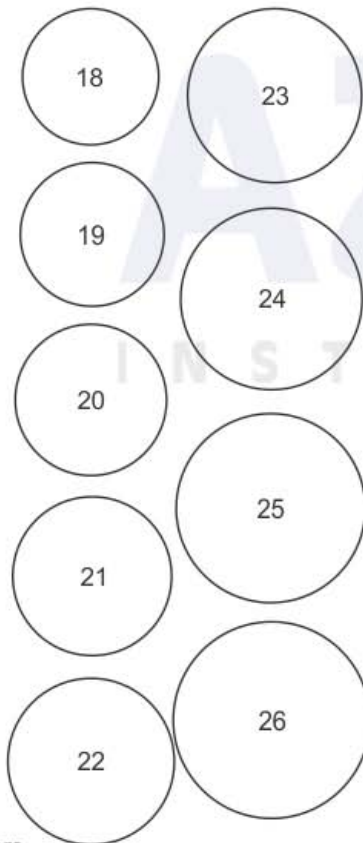

- 17-432 17cm 3-6mm
 - 17-433 17cm 4-7mm
 - 17-434 17cm 5-8mm
 - 17-435 17cm 6-9mm
 - 17-436 17cm 7-10mm
 - 17-437 17cm 8-11mm
 - 17-438 17cm 9-12mm
 - 17-439 17cm 10-13mm
 - 17-440 17cm 11-14mm
 - 17-441 17cm 12-15mm
 - 17-442 17cm 13-16mm
 - 17-443 17cm 14-17mm
 - 17-444 17cm 15-18mm
 - 17-445 17cm 16-19mm
 - 17-446 17cm 17-20mm
 - 17-447 17cm 18-21mm
- Canvas Roll Only

Hawkin Ambler Dilators
 17-431 Set of 16 Pcs



- 20cm 1/2mm
- 20cm 3/4mm
- 20cm 5/6mm
- 20cm 7/8mm
- 20cm 9/10mm
- 20cm 11/12mm
- 20cm 13/14mm
- 20cm 15/16mm
- 20cm 17/18mm
- 20cm 19/20mm
- 20cm 21/22mm
- 20cm 23/24mm
- 20cm 25/26mm
- 17-448 Set 8 Double Ended 3/4mm-17/18mm
- 17-449 Set 12 Double Ended 1/2mm-23/24mm
- 17-450 Set 8 Double Ended Canvas Only
- 17-451 Set 12 Double Ended Canvas Only

Hegar Double Ended Dilators



Hegar
with siped handle

Set	mm	pieces per set
17-452	4-17	14
17-453	1-26	26

17-454	1mm Ø	17-484	1.5mm Ø
17-455	2mm Ø	17-485	2.5mm Ø
17-456	3mm Ø	17-486	3.5mm Ø
17-457	4mm Ø	17-487	4.5mm Ø
17-458	5mm Ø	17-488	5.5mm Ø
17-459	6mm Ø	17-489	6.5mm Ø
17-460	7mm Ø	17-490	7.5mm Ø
17-461	8mm Ø	17-491	8.5mm Ø
17-462	9mm Ø	17-492	9.5mm Ø
17-463	10mm Ø	17-493	10.5mm Ø
17-464	11mm Ø	17-494	11.5mm Ø
17-465	12mm Ø	17-495	12.5mm Ø
17-466	13mm Ø	17-496	13.5mm Ø
17-467	14mm Ø	17-497	14.5mm Ø
17-468	15mm Ø	17-498	15.5mm Ø
17-469	16mm Ø	17-499	16.5mm Ø
17-470	17mm Ø	17-500	17.5mm Ø
17-471	18mm Ø	17-501	18.5mm Ø
17-472	19mm Ø	17-502	19.5mm Ø
17-473	20mm Ø	17-503	20.5mm Ø
17-474	21mm Ø	17-504	21.5mm Ø
17-475	22mm Ø	17-505	22.5mm Ø
17-476	23mm Ø	17-506	23.5mm Ø
17-477	24mm Ø		
17-478	25mm Ø		
17-479	26mm Ø		
17-480	27mm Ø		
17-481	28mm Ø		
17-482	29mm Ø		
17-483	30mm Ø		



Hegar Uterine Dilator
single ended
17-507 4 mm - 17 mm Ø
8 Pieces per set
17-508 1 mm - 26 mm Ø
24 Pieces per set



Hegar Uterine Dilator
single ended
17-509 4 mm - 17 mm Ø
24 pieces per set



17-510
20cm

GELPI
Vulva Self Retaining



DOYEN
Vaginal Flat Retractor
17-511
1.75mm x 10mm x 23cm



JOLL Thyroid Self Retaining
17-512 15.5cm



Forceps for I.U.D Removing
17-513
4 mm Ø x=230 mm



17-514
IUP Grasping Forceps 3 mm
22 cm



Schultze, Salpingograph
17-515 29.5 cm
complete in wooden case





5mm
17-516 5mm x 25mm
 11.5cm
17-517 5mm x 50mm
 14cm
17-518 5mm x 80mm
 17cm
 Cannula

HORMONE
 Implant Trocar Set



6EG 4mm
 7EG 4.5mm
 8EG 5mm
 9EG 5.5mm
 10EG 6mm

17-519 6EG S/P
17-520 7EG S/P
17-521 8EG S/P
17-522 9EG S/P
17-523 10EG S/P
 15.5 cm

FEMALE
 Catherers



8EG 5mm
 10EG 6mm
17-524 8EG S/P
17-525 10EG S/P
 19cm

ROTUNDA
 Catherers



6EG 4mm
 8EG 5mm
 10EG 6mm
 12EG 7mm

FEMALE
 Bladder Sounds
17-526 6EG S/P
17-527 8EG S/P
17-528 10EG S/P
17-529 12EG S/P
 24cm

NEEDLE EXTENSIONS



LEUR
 Needle Extensions
17-530 7.5cm
17-531 10cm
17-532 13cm



BOZEMAN
 Dressing Forceps
 27cm
 Box Joint



17-533
 Serrated



17-534
 Grooved



17-535
 Large Bow
 Serrated



BONNEY
 Vaginal Clamps
17-536
 34.5cm
 Screw Joint



VAGINAL
 Dressing Forceps
17-537
 24cm
 Serrated



Sims Uterine Sound
17-538 32 cm
right, graduated in cm
17-539 32 cm
malleable graduated in cm



Sims Uterine Sound
17-540
33 cm
right, malleable



Sims Uterine Sound
17-541
32.5cm
Non-graduated



Sims Uterine Sound
17-542
32.5cm
Graduated in cm



Sims Uterine Sound
17-543
24cm
Graduated in cm



Sims-Special Uterine Sound
17-544
33 cm

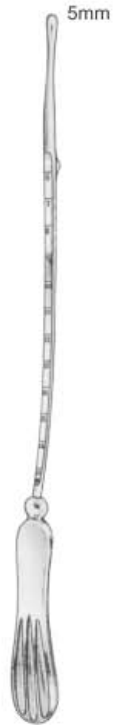

Sims Uterine Sound
schwed. Modell
17-545
26 cm



Martin Uterine Sound
17-546 30 cm



Valleix Uterine Sound
17-547 25 cm



Mayo Uterine Sound
17-548 33 cm
biegsam malleable



Simpson Uterine Sound
17-549 29 cm
malleable silver-plated



Simpson Uterine Sound
17-550 32.5cm
Graduated in inches



SMELLIE
17-551
30 cm



Braun, Midwifery
Decapitating hook
17-552
32.5 cm



Suture Retrieval
Hook
17-553
27cm



Suture Retrieval
Hook
Sims Handle
17-554
27 cm



IRIS
Skin Hooks



17-555
18cm
Fine
Colour
Coated



IRIS
Skin Hooks

17-556
25.5cm
Fine
Colour
Coated



TENACULUM EMMETT



17-557
23cm
bic



TENACULUM 3 PRONG



17-558
26cm
bic



WHITTAKER

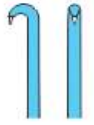

17-559
18.5cm
bic



**Second Myoma Knife
Fistula Hook**
17-560
27 cm

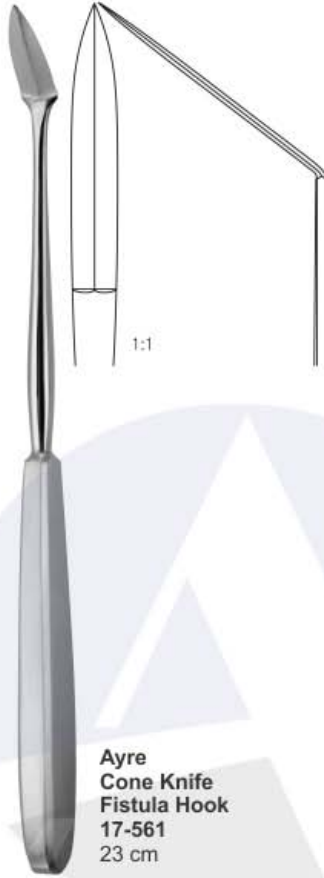

**Ayre Cone Knife
Fistula Hook**
17-561
23 cm



**Doyen Myoma Screw
And Fistula Hook**
17-562 14.5cm
17-563 17 cm

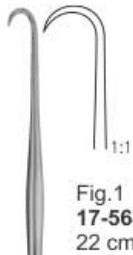

**Fig. 1
17-564
22 cm**

**Simon
Fistula Hook,
One Prong**



**Fig. 2
17-565
22 cm**

**Simon
Fistula Hook,
Two Prong**

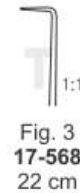

**Fig. 1
17-566
22 cm**

**Emmet
Fistula Hook**



**Fig. 2
17-567
22 cm**



**Fig. 3
17-568
22 cm**



**Fig. 4
17-569
22 cm**



**Fig. 5
17-570
22 cm**



Uni - Randall
aspirating curette
17-571 4 mm Ø
24 cm



Novak
aspirating curette
17-576 4 mm Ø
23 cm

Mini - Novak
aspirating curette
23.5 cm
17-577 1 mm Ø
17-578 2 mm Ø
17-579 3 mm Ø



Uni - Randall
aspirating curette
17-572
30 cm
rigid, without basket

Uni - Randall
aspirating curette
17-573
30 cm
malleable,
without basket



Uni - Randall
aspirating curette
17-574
30 cm
rigid, with basket

Uni - Randall
aspirating curette
17-575
30 cm
malleable,
with basket











Specimen And
Aspirating Curette
20 cm
17-580 3 mm Ø
17-581 4 mm Ø
17-582 6 mm Ø
17-583 8 mm Ø
17-584 10 mm Ø
17-585 12 mm Ø
17-586 14 mm Ø



Coupling Piece
aspirating curette
12 cm
17-587

Küretten spülen | Curetas de lavado
Curettes de rinçage | Curette di lavaggio

 <p>17-588 Small 29cm 8mm Sharp</p> <p>17-589 Medium 29cm 11mm Sharp</p> <p>17-590 Large 29cm 14mm Sharp</p> <p>Rheinstadter Flushing Curettes</p>	 <p>8.0mm</p> <p>17-591 Small 29cm 8mm Blunt</p> <p>17-592 Medium 29cm 11mm Blunt</p> <p>17-593 Large 29cm 14mm Blunt</p> <p>Rheinstadter Flushing Curettes</p>	 <p>17-594 12 FG 4mm 25.5cm</p> <p>Leechwilkinson Suction Biopsy Curettes</p>	 <p>1mm 25.5cm 2mm 25.5cm 3mm 25.5cm 4mm 25.5cm</p> <p>1 • 17-595 2 • 17-596 3 • 17-597 4 • 17-598</p> <p>Novak Suction Biopsy Curettes</p>	 <p>2mm 25.5cm 3mm 25.5cm 4mm 25.5cm</p> <p>2 • 17-599 3 • 17-600 4 • 17-601</p> <p>Randall Suction Biopsy Curettes</p>
---	--	--	--	---

 <p>17-602 10FG 23cm C/P</p> <p>Sharman Endometrial Biopsy Curettes</p>	 <p>10FG 3.3mm</p> <p>17-603 17-604</p> <p>17-605 17-606</p> <p>17-607 17-608</p> <p>SCHROEDER 30 cm, 12" sharp, rigid</p>	 <p>17-609 30 cm 1.2mm</p> <p>17-610 30 cm 4.0 mm Without Basket</p> <p>17-611 30 cm 4.0 mm With Basket</p> <p>KEVORKIAN</p>	 <p>17-612 30.5cm</p> <p>Kevorkian Endocervical Curettes With Basket Round</p>
--	--	---	---

Uteruslöffel, Absaugküretten, uterusdepressor

Curettes uterines, curettes d'aspiration, Dépresseur utérin^x

Cucharillas uterinas, Curetas aspiradoras, depresor uterino

Curette uterine, curette pe aspirazione, depressore uterino



17-613
30.5cm



17-614
30.5cm



Braun Uterine Depressor
17-615 28 cm



Blake Double Ended
17-616 24.5 cm
Sharp / Blunt

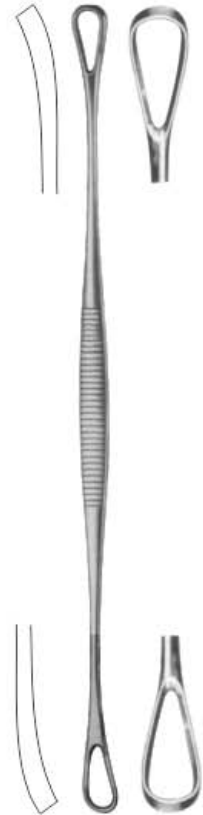

Zweifel Double Ended
17-617 24.5cm
Sharp / Sharp

Kevorkian Endocervical Curettes
With Basket Square

Kevorkian Endocervical Curettes
Without Basket Square



Coakley
17cm



17-618
Fig. 1



17-619
Fig. 2



17-620
Fig. 3



17-621
Fig. 4



17-622
Fig. 5



17-623
Fig. 6

Uterusküretten | Currettes uterinas
Currettes utérines | Curette uterine

Sims Single Ended Sharp

17-624
Small 6mm
Sharp 25.5cm

17-627
Small 6mm
Blunt 25.5cm

17-625
Medium 9mm
Sharp 25.5cm

17-628
Medium 9mm
Blunt 25.5cm

17-626
Large 12mm
Sharp 25.5cm

17-629
Large 12mm
Blunt 25.5cm

Sims Single Ended S/S

17-630
Small 6mm X 5mm
Sharp
Sharp 25.5cm

17-631
Medium
9mm X 6mm Sharp
Sharp 25.5cm

17-632
Large
12mm X 9mm Sharp
Sharp 25.5cm

Blake 17-633
27 cm

Sims 17-634
26 cm

17-635
Small
6mm X 5mm Sharp
Blunt 25.5mm

17-636
Medium
9mm X 6mm Sharp
Blunt 25.5mm

17-637
Large
12mm X 9mm Sharp
Blunt 25.5mm

Sims Double Ended B/S

Sims 17-638
Double Ended
Sharp Blunt



Recamier uterine curette y=26 cm	Fig.	x=mm	Sharp, malleable	Blunt, malleable	Sharp, rigid	Blunt, rigid
	00	5	17-639	17-653	17-667	17-681
	0	6	17-640	17-654	17-668	17-682
	1	7	17-641	17-655	17-669	17-683
	2	8	17-642	17-656	17-670	17-684
	3	9	17-643	17-657	17-671	17-685
	4	11	17-644	17-658	17-672	17-686
	5	12	17-645	17-659	17-673	17-687
	6	14	17-646	17-660	17-674	17-688
	7	15	17-647	17-661	17-675	17-689
	8	16	17-648	17-662	17-676	17-690
	9	19	17-649	17-663	17-677	17-691
	10	20	17-650	17-664	17-678	17-692
	11	21	17-651	17-665	17-679	17-693
	12	23	17-652	17-666	17-680	17-694

Recamier uterine curette y=31 cm	Fig.	x=mm	Sharp, malleable	Blunt, malleable	Sharp, rigid	Blunt, rigid
	00	5	17-695	17-709	17-723	17-737
	0	6	17-696	17-710	17-724	17-738
	1	7	17-697	17-711	17-725	17-739
	2	8	17-698	17-712	17-726	17-740
	3	9	17-699	17-713	17-727	17-741
	4	11	17-700	17-714	17-728	17-742
	5	12	17-701	17-715	17-729	17-743
	6	14	17-702	17-716	17-730	17-744
	7	15	17-703	17-717	17-731	17-745
	8	16	17-704	17-718	17-732	17-746
	9	19	17-705	17-719	17-733	17-747
	10	20	17-706	17-720	17-734	17-748
	11	21	17-707	17-721	17-735	17-749
	12	23	17-708	17-722	17-736	17-750



Fig. 13



Fig. 14



Fig. 15



Fig. 16

Fig.	x=mm	Sharp, malleable	Blunt, malleable	Sharp, rigid	Blunt, rigid
13	25	17-751	17-755	17-759	17-763
14	30	17-752	17-756	17-760	17-764
15	35	17-753	17-757	17-761	17-765
16	40	17-754	17-758	17-762	17-766

Recamier
uterine curette
y=34 cm



Fig. 1



Fig. 2



Fig. 3



Fig. 4



Fig. 5

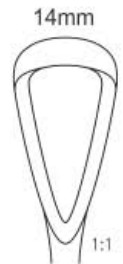

Fig. 6

Fig.	x=mm	Sharp, malleable	Sharp, rigid	Blunt, malleable	Blunt, rigid
1	7	17-767	17-773	17-779	17-785
2	8	17-768	17-774	17-780	17-786
3	9	17-769	17-775	17-781	17-787
4	11	17-770	17-776	17-782	17-788
5	12	17-771	17-777	17-783	17-789
6	14	17-772	17-778	17-784	17-790

Sims
uterine curette
28 cm



Fig. 1
17-791
25 cm
Sharp, rigid



Fig. 2
17-792
25 cm
Sharp, rigid



Fig. 3
17-793
25 cm
Sharp, rigid



Fig. 4
17-794
25 cm
Sharp, rigid



Fig. 5
17-795
25 cm
Sharp, rigid

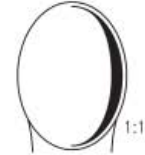

Fig. 6
17-796
25 cm
Sharp, rigid

Schröder
Uterine Spoon



Fig. 1
17-797
30 cm



Fig. 2
17-798
30 cm



Fig. 3
17-799
30 cm



Fig. 4
17-800
30 cm

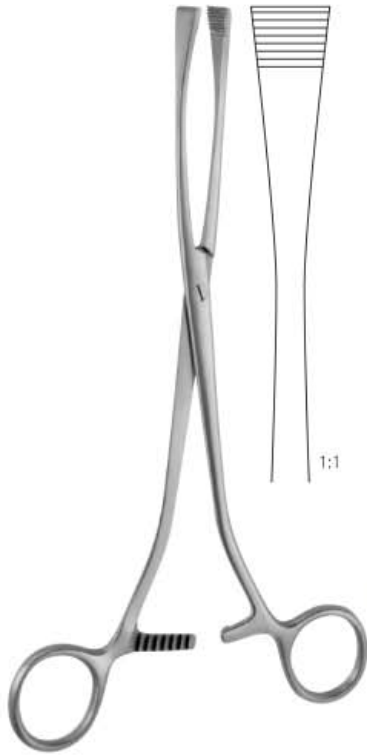

Fig. 5
17-801
30 cm



Fig. 6
17-802
30 cm

Schröder
Uterine Spoon



Green-Armytage
Uterine Elevating Forceps
17-803 21 cm



Smellie
Obstetrical Forceps
17-804 25 cm
Perforator



NAEGELE
17-805
25 cm

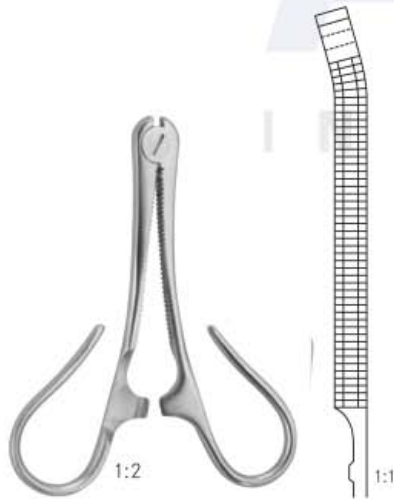

Kane
obstetrical forceps
17-806
8.5 cm



Collin
Obstetrical Forceps
17-807
9 cm



Zimmerman
Myotome,
Spoon Tip,
17-808
24 cm



Zimmerman
Myotome,
Chisel Tip,
17-809
29 cm

Abortuszangen - Abortusküretten

Pinzas para abort - Curetas para aborto

Pinces à faux germes - Curette d'avortement

Pinze per placenta ed aborto - Curette per placenta ed aborto

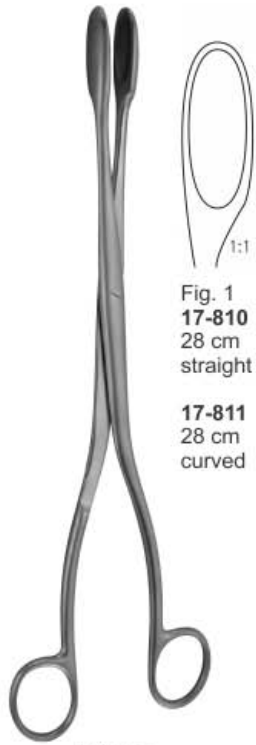

Winter
abortion forceps

Fig. 1
17-810
28 cm
straight

17-811
28 cm
curved



Fig. 2
17-812
28 cm
straight

17-813
28 cm
curved

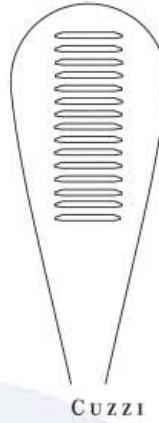

Fig. 3
17-814
28 cm
straight

17-815
28 cm
curved



Cuzzi
ovum curette
blunt, back serrated



C U Z Z I



14.5 mm
17-816
30 cm



18 mm
17-817
30 cm



21 mm
17-818
30 cm



Saenger
Abortion Forceps



17-819
27 cm
Straight

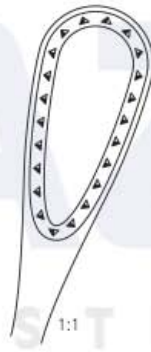

17-820
27 cm
Curved



Wallich
ovum curette
17-821 42 cm



Pestaloza
Ovum Curette
17-822 30 cm

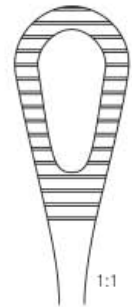

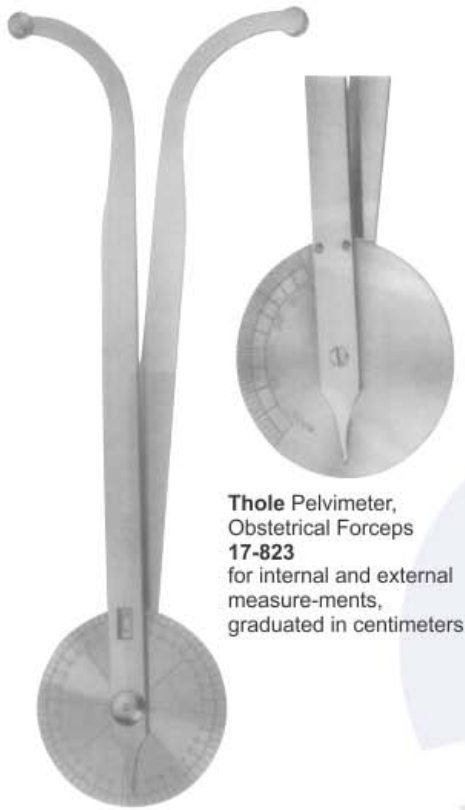

Thole Pelvimeter, Obstetrical Forceps 17-823
for internal and external measurements, graduated in centimeters



De Lee Pelvimeter, Obstetrical Forceps 17-824
graduated in centimeters and inches



Collin Pelvimeter, Obstetrical Forceps 17-825
Graduated in Centimeters



Martin Pelvimeter, Obstetrical Forceps 17-826
graduated in centimeters

for internal measurements between symphysis and promontory



Collin Pelvimeter, Obstetrical Forceps 17-827
graduated in centimeters

The additional straight arm can be replaced. The pelvimeter with straight arm is used for localisation of the portio vaginalis uteri and of vaginal metastasis.



Breisky Pelvimeter, Obstetrical Forceps 17-828
graduated in centimeters



Simpson
 Obstetrical Forceps
 17-829 23 cm
 17-830 30 cm
 17-831 33 cm
 17-832 36 cm



Simpson - Braun
 Obstetrical Forceps
 17-833 33 cm
 17-834 36 cm



Naegele
 Obstetrical Forceps
 17-835 36 cm
 17-836 40 cm



Piper
 obstetrical forceps
 17-837 44 cm



Simpson - Luikart
 Obstetrical Forceps
 17-838 36 cm



Wrigley
 Obstetrical Forceps
 17-839 25 cm
 17-840 28 cm
 for caesarian section



De Lee
 obstetrical forceps
 17-841 30 cm



De Lee
 obstetrical forceps
 17-842 36 cm
 17-843 15 cm



Elliot
 obstetrical forceps
 17-844 32 cm
 17-845 38 cm

Geburtszangen
 Forceps obstétricus

Forceps obstétricos
 Forcipi



McLean
 obstetrical forceps
 17-846 36 cm



Kielland
 Obstetrical Forceps
 17-847 41 cm



Kielland-Luikart
 obstetrical forceps
 17-848 40 cm

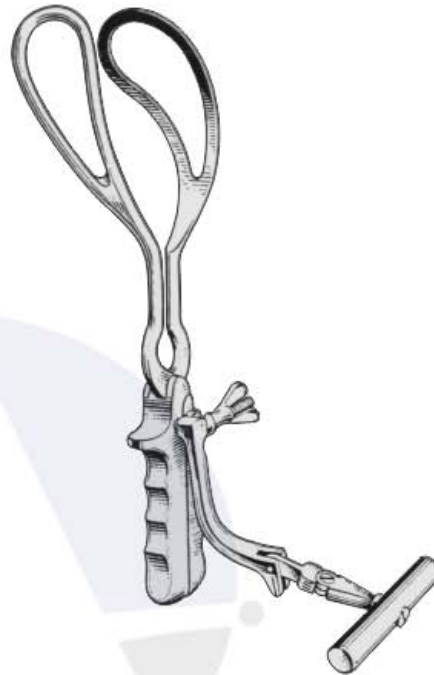

Barnes-Neville
 17-849 40 cm
 Simpson handles, detachable
 axis traction rod and handle.



Bil Obstetrical
Holder
 17-850



Barnes-Neville
 Obstetrical Forceps
 17-851
 with traction
 handle 43.5 cm



Braun
 obstetrical forceps
 17-852
 42 cm
 Cranioclast, one
 jaw fenestrated



Tarnier
 obstetrical forceps
 17-853
 46 cm
 Basiotribe



Sellheim
 Obstetrical Lever
 17-854
 28 cm

LIPOSUCTION CANNULAS AND SETS





18-001
 2mmØ
 25cm
 10holes



18-002
 3 mm Ø
 25 cm
 10 holes



Cannulas
18-003
 9 x 70 mm Ø
18-004
 1 x 120 mm Ø
 Packing unit 100 pieces, steril



18-005
 Luer-Lock syringes
 Adaptor with Luer-Lock connection, for use of
 cannulas with handle connector on



18-006
 Accessories for Syringes

Cannulas For Iniltration
 Measurements = working length



Ø 1,0 mm

18-007
 2 mm Ø
 15 cm
 18 holes

Entner Cannulas



Ø 1,5 mm

18-008
 3 mm Ø
 15 cm
 18 holes



Ø 1,0 mm

18-009
 2 mm Ø
 15 cm
 18 holes

Entner Cannulas
 Measurements = working length



Ø 1,5 mm

18-010
 3 mm Ø
 15 cm
 18 holes



Ø 1,5 mm

18-011
 3 mm Ø
 20 cm
 22 holes

Entner Cannulas
 Measurements = working length



Ø 2,0 mm

18-012
 4 mm Ø
 20 cm
 22 holes



Ø 1,5 mm

18-013
 3 mm Ø
 20 cm
 22 holes

Entner Cannulas



Ø 2,0 mm

18-014
 4 mm Ø
 20 cm
 22 holes



Measurements = working length



Measurements = working length

The bayonet shaped handles allow an easier manipulation.



**Entner
Cannulas**

Ø 1,5 mm



18-027
3 mm Ø
20 cm
22 holes



**Entner
Cannulas**

Measurements = working length

Ø 1,5 mm



18-028
3 mm Ø
20 cm
22 holes



**Entner
Cannulas**

Measurements = working length

Ø 1,0 mm

For fine facial and neck
contouring.



18-029
2 mm Ø
15 cm
8 holes



**Entner
Cannulas**

Measurements = working length

Ø 1,0 mm



18-030
2 mm Ø
15 cm
8 holes



Face Cannulas
18-031
15 cm
2 mm Ø



18-032
5 cm 1,7 mm Ø
18-033
15 cm 1,7 mm Ø



Neck Cannulas
18-034
15 cm
3 mm Ø



Neck Cannulas
18-035
20 cm
3 mm Ø



Neck Cannulas
18-036
15 cm
2 mm Ø



18-037
5 cm 2 mm Ø
18-038
5 cm 3 mm Ø
18-039
15 cm 2 mm Ø
18-040
15 cm 3 mm Ø



Thigh - Lower Leg Cannulas
18-041 20 cm 3 mm Ø
18-042 30 cm 3 mm Ø
18-043 20 cm 4 mm Ø
18-044 30 cm 4 mm Ø



Abdomen / Saddlebag Cannulas
18-045 20 cm 3 mm Ø
18-046 20 cm 4 mm Ø



Abdomen / Saddlebag Cannulas
18-047 30 cm 3 mm Ø
18-048 30 cm 4 mm Ø



18-049
with rotatable tube connection
Accessories



Fork shape, rounded tips, dissecting surface between tips / one central hole.



The improved arrangement of the suction holes ensures a more effective and gentle suction in areas with much connective tissue and in case of gynecomasty.



18-065
3 mm Ø
20 cm

18-067
4 mm Ø
30 cm

18-068
5 mm Ø
30 cm

18-069
6 mm Ø
30 cm

18-066
3 mm Ø
30 cm

one central hole, two lateral holes
Measurements = working length

Cannulas



18-070
3 mm Ø
20 cm

18-072
4 mm Ø
30 cm

18-073
5 mm Ø
30 cm

18-074
6 mm Ø
30 cm

18-071
3 mm Ø
30 cm

two lateral holes,
one central hole

Cannulas

Measurements = working length



18-075
3 mm Ø
20 cm

18-076
3 mm Ø
30 cm



18-077
4 mm Ø
30 cm

18-078
4 mm Ø
40 cm



18-079
5 mm Ø
30 cm



18-080
6 mm Ø
30 cm



18-081
4 mm Ø
30 cm



18-082
5 mm Ø
30 cm

Cannulas
three holes, diagonal
Measurements = working length

Cannulas
one central hole, two lateral holes
Measurements = working length



18-083
3 mm Ø
20 cm

18-084
3 mm Ø
30 cm



18-085
30 cm



6 mm

Cannulas
Point with hole, one lateral hole

Cannulas
Measurements = working length

For facial contouring.
one lateral hole



Cannulas
with handle connector



18-086
1,7 mm Ø
5 cm

18-087
1,7 mm Ø
15 cm



18-088
2 mm Ø
5 cm

18-089
2 mm Ø
15 cm



18-090
3 mm Ø
5 cm

18-091
3 mm Ø
15 cm



Cannulas
with Luer-Lock connection
Measurements = working length

18-092
1,7 mm Ø
5 cm

18-093
1,7 mm Ø
15 cm

18-094
2 mm Ø
5 cm

18-095
2 mm Ø
15 cm

18-096
3 mm Ø
5 cm

18-097
3 mm Ø
15 cm

Handles with connection thread for cannulas and hose connection 0 13 mm, for operation with a suction pump.

Recommended handles for the tumescence local anaesthesia technique
Hole for interrupting the suction process



18-098
Fix Handle



18-099
with rotatable tube connection
Handle



18-100
Fix Handle



18-101
with rotatable tube connection
Handle



Liposuction cannulas, stainless steel with thumb plate and hose connection \varnothing 13 mm, for use with a suction pump.



Gasparotti Cannulas
Measurements = working length



18-102
3 mm \varnothing
15 cm
one central hole



18-103
4 mm \varnothing
25 cm
one central hole



18-104
6 mm \varnothing
15 cm
one central hole



18-105
6 mm \varnothing
25 cm
one central hole



18-106
9 mm \varnothing
30 cm
one central hole



Gasparotti Cannulas
Measurements = working length



18-107
4 mm \varnothing
15 cm
two central holes



18-108
4 mm \varnothing
25 cm
two central holes



18-109
6 mm \varnothing
30 cm
two central holes



Gasparotti Cannulas
Measurements = working length



18-110
3 mm \varnothing
15 cm
one central hole



18-111
6 mm \varnothing
15 cm
one central hole



18-112
6 mm \varnothing
25 cm
one central hole

Liposuction Cannulas Set



18-113

- Liposuction Cannula Set for Abdomen and Saddlebag With Threaded Fitting
- Liposuction Cannula with threaded connector, 22-Holes, diameter 3.0 mm, working length 20cm
- Liposuction Cannula with threaded connector, 22-Holes, diameter 4.0 mm, working length 20cm
- Liposuction Cannula with threaded connector, 30-Holes, diameter 3.0 mm, working length 30cm
- Liposuction Cannula with threaded connector, 30-Holes, diameter 4.0 mm, working length 30cm
- Liposuction Cannula Handle
- Liposuction Cannula Handle with Interrupting Hole



18-114

- Liposuction Cannula Set for Face with Luer Lock Fitting
- Liposuction Cannula, with one central hole, diameter 1.7 mm, working length 5 cm
- Liposuction Cannula, with one central hole, diameter 1.7 mm, working length 15 cm
- Liposuction Cannula, 18-Holes, diameter 2.0 mm, working length 15 cm



18-115

- Liposuction Cannula Set for Face with Threaded Fitting
- Liposuction Cannula, with one central hole, diameter 1.7 mm, working length 5 cm
- Liposuction Cannula, with one central hole, diameter 1.7 mm, working length 15 cm
- Liposuction Cannula, 18-Holes, diameter 2.0 mm, working length 15 cm
- Liposuction Cannula Handle
- Liposuction Cannula Handle with Interrupting Hole

18-116

- Liposuction Cannula Set for Neck
- Liposuction Cannula with Luer-Lock, with one central hole, diameter 2.0 mm, working length 5cm
- Liposuction Cannula with Luer-Lock, with one central hole, diameter 3.0 mm, working length 5cm
- Liposuction Cannula with Luer-Lock, with one central hole, diameter 2.0 mm, working length 15cm
- Liposuction Cannula with Luer-Lock, with one central hole, diameter 3.0 mm, working length 15cm
- Liposuction Cannula with threaded connector, 18-Holes, diameter 3.0 mm, working length 15 cm
- Liposuction Cannula with threaded connector, Angled, 22-Holes, diameter 3.0 mm, working length 20 cm
- Liposuction Cannula with threaded connector, 8-Holes, diameter 2.0 mm, working length 15 cm
- Liposuction Cannula Handle
- Liposuction Cannula Handle with Interrupting Hole

Liposuction Cannulas Set

18-117

- Liposuction Cannula Set for Thie and Lower Leg with Threaded Fitting
- Liposuction Cannula with threaded connector, byonet shape, 22-Holes, diameter 3.0 mm, working length 20 cm
- Liposuction Cannula with threaded connector, byonet shape, 22-Holes, diameter 4.0 mm, working length 20 cm
- Liposuction Cannula with threaded connector, byonet shape, 30-Holes, diameter 3.0 mm, working length 30 cm
- Liposuction Cannula with threaded connector, byonet shape, 30-Holes, diameter 4.0 mm, working length 30 cm
- Liposuction Cannula Handle
- Liposuction Cannula Handle with Interrupting Hole

18-118

- Micro Fat Injection Cannulas Set
- Open Port Injector Cannula, 1.2mm, 10cm, Luer Lock
- Multi Holes Harvester Cannula Model 2, 2.5mm, 20cm, Luer Lock
- Tumescent Infiltrator Cannula, 1.5mm, 12cm Luer Lock
- Micro Injector Cannula, 0.8mm, 4cm, Luer Lock
- Micro Injector Cannula, 1.0mm, 5cm, Luer Lock
- Holding Device
- Luer Lock Syringe Cap

Safe Cannula Set
18-119

- 1 TWO STANDARD HOLE LIPOSUCTION CANNULA, 3.5mm, 25cm, Super Handle
- 2 Mercedes Liposuction Cannula, 5.0mm, 30cm, Super Handle
- 3 Mercedes Liposuction Cannula, 4.5mm, 30cm, Super Handle
- 4 Mercedes Liposuction Cannula, 4.0mm, 25cm, Super Handle
- 5 Single Basket Liposuction Cannulas, 4.0mm, 30cm, Super Handle
- 6 Double Basket Liposuction Cannulas, 4.0mm, 30cm, Super Handle
- 7 Triple Basket Liposuction Cannulas, 4.0mm, 30cm, Super Handle
- 8 Spiral Three Port Harvester Cannula, 3.0mm, 20cm, Super Handle
- 9 Spiral Three Port Harvester Cannula, 4.0mm, 25cm, Super Handle
- 10 Three Port Harvester Cannula, Model 4, 4.5mm, 30cm, Super Handle
- 11 Three Ports Pyramid Cannula, 3.5mm, 25cm, Super Handle
- 12 Basket Cannula, 5.0mm, 32cm, Super Handle



Fat Injection Syringes

Fat Suction Syringes

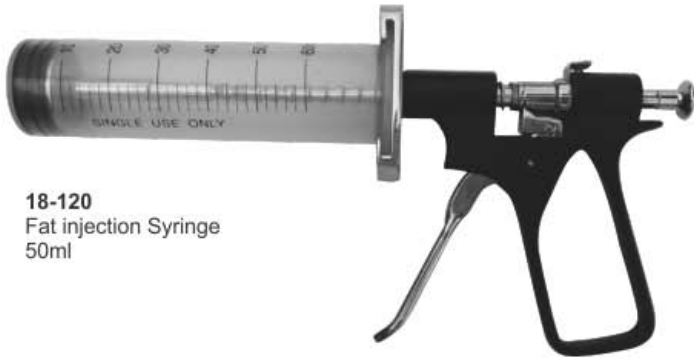

18-120
Fat injection Syringe
50ml

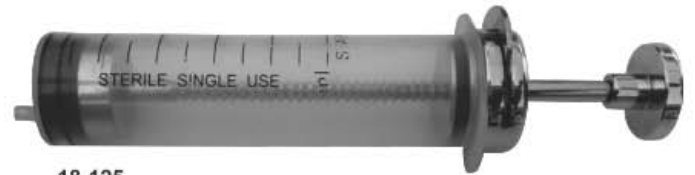

18-125
Fat Suction Syringe
50 ml



18-121
Universal Fat Injection syringe
20ml



18-126
Fat Suction Syringe
50 ml



18-122
Universal Fat Injection syringe
10ml

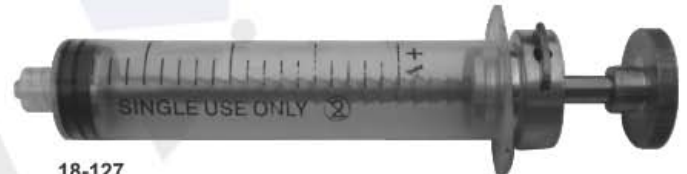

18-127
Fat Suction Syringe
20 ml



18-123
Fat Injection Syringes
0.1 ml per click
1 ml



18-128
Fat Suction Syringe
10 ml



18-124
Fat Injection Syringe
3 ml special
0.1 ml per click



18-129
Fat Suction Syringe
5 ml



18-130
Fat Suction Syringe
3 ml

HOLLOW WARES



STERILIZING DRUMS

	Ø	h
	mm	mm
19-001	80	80
19-002	120	120
19-003	160	120
19-004	190	140
19-005	190	200
19-006	240	120
19-007	240	160
19-008	240	240
19-009	290	120
19-010	290	160
19-011	290	240
19-012	340	160
19-013	340	240
19-014	390	145
19-015	390	200
19-016	390	290

STERILIZING DRUM

	Ø	h
	mm	Size mm
19-017	150	150
19-018	175	175
19-019	190	190
19-020	200	140
19-021	200	200
19-022	240	120
19-023	225	225
19-024	240	240
19-025	290	160
19-026	280	240
19-027	230	150
19-028	300	250
19-029	340	250
19-030	350	250
19-031	390	200

STERILIZING DRUM

	Ø	h
	mm	Size mm
19-032	150	150
19-033	175	175
19-034	190	190
19-035	200	140
19-036	200	200
19-037	240	120
19-038	225	225
19-039	240	240
19-040	290	160
19-041	280	240
19-042	230	150
19-043	300	250
19-044	340	250
19-045	350	250
19-046	390	200

STERILIZING DRUM

	Ø	h
	mm	Size mm
19-047	150	150
19-048	175	175
19-049	190	190
19-050	200	140
19-051	200	200
19-052	240	120
19-053	225	225
19-054	240	240
19-055	290	160
19-056	280	240
19-057	230	150
19-058	300	250
19-059	340	250
19-060	350	250
19-061	390	200

STERILIZING DRUM

	Ø	h
	mm	Size mm
19-062	150	150
19-063	175	175
19-064	190	190
19-065	200	140
19-066	200	200
19-067	240	120
19-068	225	225
19-069	240	240
19-070	290	160
19-071	280	240
19-072	230	150
19-073	300	250
19-074	340	250
19-075	350	250
19-076	390	200



G LOVES BOX
19-077
300 x 150 mm



**INSTRUMENT TRAY
WITH COVER**
19-078



INSTRUMENT TRAY
19-079



CATHER TRAY

	Size
19-080	230 x 75 mm
19-081	350 x 90 mm
19-082	430 x 100 mm
19-083	200 x 100 mm
19-084	300 x 100 mm
19-085	350 x 100 mm

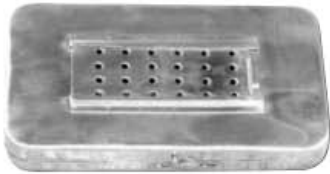

PERFORATED BOX

	Size
19-086	100 x 50 mm
19-087	165 x 65 mm
19-088	250 x 100 mm
19-089	250 x 150 mm
19-090	250 x 200 mm
19-091	150 x 65 mm
19-092	170 x 70 mm
19-093	200 x 100 mm
19-094	250 x 125 mm
19-095	300 x 150 mm
19-096	300 x 200 mm
19-097	300 x 130 mm
19-098	320 x 150 mm
19-099	420 x 180 mm
19-100	460 x 125 mm
19-101	355 x 180 mm
19-102	300 x 180 mm
19-103	400 x 200 mm
19-104	510 x 200 mm



BOX WITH FILTER

	Size
19-105	100 x 50 mm
19-106	165 x 65 mm
19-107	250 x 100 mm
19-108	250 x 150 mm
19-109	250 x 200 mm
19-110	150 x 65 mm
19-111	170 x 70 mm
19-112	200 x 100 mm
19-113	250 x 125 mm
19-114	300 x 150 mm
19-115	300 x 200 mm
19-116	300 x 130 mm
19-117	320 x 150 mm
19-118	420 x 180 mm
19-119	460 x 125 mm
19-120	355 x 180 mm
19-121	300 x 180 mm
19-122	400 x 200 mm
19-123	510 x 200 mm



INSTRUMENTS BOX

Without Clip	Size
19-124	100 x 50 mm
19-125	165 x 65 mm
19-126	250 x 100 mm
19-127	250 x 150 mm
19-128	250 x 200 mm
19-129	150 x 65 mm
19-130	170 x 70 mm
19-131	200 x 100 mm
19-132	250 x 125 mm
19-133	300 x 150 mm
19-134	300 x 200 mm
19-135	300 x 130 mm
19-136	320 x 150 mm
19-137	420 x 180 mm
19-138	460 x 125 mm
19-139	355 x 180 mm
19-140	300 x 180 mm
19-141	400 x 200 mm
19-142	510 x 200 mm



INSTRUMENT BOX

With Clip	Size
19-143	100 x 50 mm
19-144	165 x 65 mm
19-145	250 x 100 mm
19-146	250 x 150 mm
19-147	250 x 200 mm
19-148	150 x 65 mm
19-149	170 x 70 mm
19-150	200 x 100 mm
19-151	250 x 125 mm
19-152	300 x 150 mm
19-153	300 x 200 mm
19-154	300 x 130 mm
19-155	320 x 150 mm
19-156	420 x 180 mm
19-157	460 x 125 mm
19-158	355 x 180 mm
19-159	300 x 180 mm
19-160	400 x 200 mm
19-161	510 x 200 mm

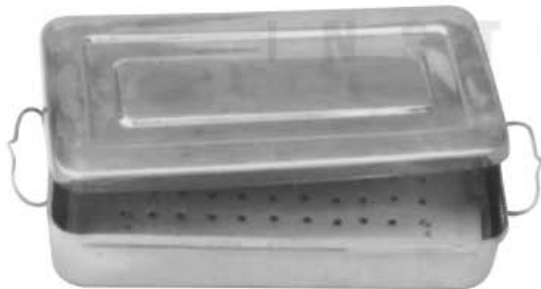

INSTRUMENT BOILER

	Size
19-162	180 x 80 x 40 mm
19-163	200 x 100 x 50 mm
19-164	250 x 125 x 40 mm
19-165	300 x 150 x 60 mm
19-166	350 x 175 x 75 mm
19-167	400 x 200 x 100 mm

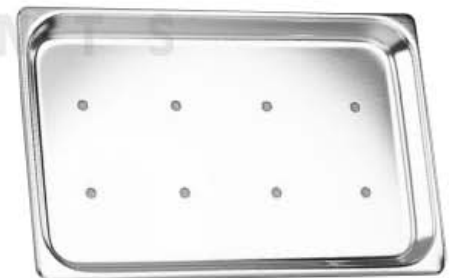

PERFORATED TRAY

	Size
19-168	180 x 80 x 40 mm
19-169	200 x 100 x 50 mm
19-170	250 x 125 x 40 mm
19-171	300 x 150 x 60 mm
19-172	350 x 175 x 75 mm
19-173	400 x 200 x 100 mm

INSTRUMENT BOILER ELECTRIC

	Size
19-174	180 x 80 x 40 mm
19-175	200 x 100 x 50 mm
19-176	250 x 125 x 40 mm
19-177	300 x 150 x 60 mm
19-178	350 x 175 x 75 mm
19-179	400 x 200 x 100 mm

INSTRUMENT BOILER WITH STAND

	Size
19-180	180 x 80 x 40 mm
19-181	200 x 100 x 50 mm
19-182	250 x 125 x 40 mm
19-183	300 x 150 x 60 mm
19-184	350 x 175 x 75 mm
19-185	400 x 200 x 100 mm



NEEDLE CASE
19-186
230 x 125 mm

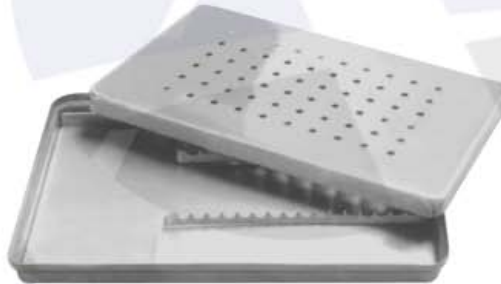

SCALER BOX
19-187
300 x 180 mm



SCALER TRAY
19-188
100 x 200 mm



INDO BOX WITH SILVER FRAME
19-189



Autoclaveable Fire Holder
19-190

INSTRUMENT TRAY WITHOUT COVER

	Size		Size
19-191	240 x 240 mm	19-202	230 x 125 mm
19-192	355 x 400 mm	19-203	200 x 150 mm
19-193	300 x 150 mm	19-204	250 x 200 mm
19-194	300 x 180 mm	19-205	300 x 250 mm
19-195	300 x 240 mm	19-206	350 x 300 mm
19-196	340 x 320 mm	19-207	400 x 350 mm
19-197	230 x 180 mm	19-208	450 x 300 mm
19-198	250 x 130 mm	19-209	300 x 200 mm
19-199	200 x 130 mm	19-210	350 x 250 mm
19-200	180 x 130 mm	19-211	250 x 125 mm
19-201	150 x 100 mm	19-212	200 x 100 mm
		19-213	400 x 200 mm

INSTRUMENT TRAY WITHOUT COVER

	Size		Size
19-214	240 x 240 mm	19-225	230 x 125 mm
19-215	355 x 400 mm	19-226	200 x 150 mm
19-216	300 x 150 mm	19-227	250 x 200 mm
19-217	300 x 180 mm	19-228	300 x 250 mm
19-218	300 x 240 mm	19-229	350 x 300 mm
19-219	340 x 320 mm	19-230	400 x 350 mm
19-220	230 x 180 mm	19-231	450 x 300 mm
19-221	250 x 130 mm	19-232	300 x 200 mm
19-222	200 x 130 mm	19-233	350 x 250 mm
19-223	180 x 130 mm	19-234	250 x 125 mm
19-224	150 x 100 mm	19-235	200 x 100 mm
		19-236	400 x 200 mm

KIDNEY TRAY WITH COVER
(English Pattern)

	Size
19-237	150 mm
19-238	200 mm
19-239	240 mm
19-240	300 mm

KIDNEY TRAY (German Pattern)
(without cover)

	Size
19-241	150 mm
19-242	200 mm
19-243	240 mm
19-244	300 mm

SPLIT LAMP
19-245
100 ml.

BOWL

	Size
19-246	80 mm
19-247	100 mm
19-248	125 mm
19-249	150 mm
19-250	200 mm
19-251	250 mm
19-252	300 mm
19-253	350 mm
19-254	400 mm

WASH BASIN

	Size
19-255	80 mm
19-256	100 mm
19-257	125 mm
19-258	150 mm
19-259	200 mm
19-260	250 mm
19-261	300 mm
19-262	350 mm
19-263	400 mm

BOWL

	Size
19-264	80 mm
19-265	100 mm
19-266	125 mm
19-267	150 mm
19-268	200 mm
19-269	250 mm
19-270	300 mm
19-271	350 mm
19-272	400 mm

AZQA
I N S T R U M E N T S

DRESSING JAR WITH KNOB

	Size
19-273	80 x 80 mm
19-274	100 x 100 mm
19-275	125 x 125 mm
19-276	150 x 150 mm
19-277	200 x 200 mm

DRESSING JAR

	Size
19-278	80 x 80 mm
19-279	100 x 100 mm
19-280	125 x 125 mm
19-281	150 x 150 mm
19-282	200 x 200 mm

DRESSING JAR

	Size
19-283	80 x 80 mm
19-284	100 x 100 mm
19-285	125 x 125 mm
19-286	150 x 150 mm
19-287	200 x 200 mm

DRESSING JAR

	Size
19-288	80 x 80 mm
19-289	100 x 100 mm
19-290	125 x 125 mm
19-291	150 x 150 mm
19-292	200 x 200 mm

**FORCEPS
JAR**

	Size
19-293	55 x 100 mm
19-294	55 x 140 mm
19-295	55 x 170 mm
19-296	55 x 180 mm
19-297	80 x 100 mm

**FORCEPS
JAR**

	Size
19-298	55 x 100 mm
19-299	55 x 140 mm
19-300	55 x 170 mm
19-301	55 x 180 mm
19-302	80 x 100 mm

**FORCEPS
JAR**

	Size
19-303	55 x 100 mm
19-304	55 x 140 mm
19-305	55 x 170 mm
19-306	55 x 180 mm
19-307	80 x 100 mm

**FORCEPS
JAR**

	Size
19-308	55 x 100 mm
19-309	55 x 140 mm
19-310	55 x 170 mm
19-311	55 x 180 mm
19-312	80 x 100 mm

**FORCEPS
JAR**

	Size
19-313	55 x 100 mm
19-314	55 x 140 mm
19-315	55 x 170 mm
19-316	55 x 180 mm
19-317	80 x 100 mm

**COTTON HOLDER
19-318**

GALIPOTS

	Capacity
19-319	2 Ounces
19-320	3 Ounces
19-321	4 Ounces
19-322	5 Ounces
19-323	6 Ounces
19-324	7 Ounces
19-325	8 Ounces

GALIPOTS

	Capacity
19-326	2 Ounces
19-327	3 Ounces
19-328	4 Ounces
19-329	5 Ounces
19-330	6 Ounces
19-331	7 Ounces
19-332	8 Ounces

**SPRIT LAMP
19-333
100 ml.**

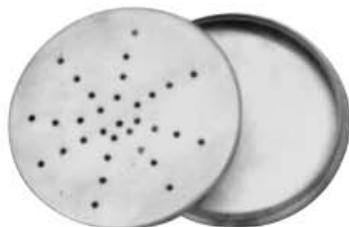
**INDO BOX ROUND
19-334**

**NEEDLE CASE
19-335**

MEASURING JUG

	Capacity
19-336	1.00 Ltr
19-337	1.50 Ltr
19-338	2.00 Ltr

MEDICINE CUP GRADUATED

	Capacity
19-339	50 ml
19-340	60 ml
19-341	100 ml

BUCKET WITH LID

	Capacity
19-342	10 Ltr
19-343	12 Ltr
19-344	15 Ltr



SPUTUM MUG
19-345
 100 x 50 mm



ENEMA CANE
 Capacity
19-346 0.5 Ltr
19-347 1.5 Ltr
19-348 2.0 Ltr



DUST BIN
19-349
 20 Lit



ROUND BEDPAN
19-350
 300 x 85 mm



BEDPAN
19-351
 Size: Adult, Child



BEDPAN
19-352
 Size: Adult, Child



FUNNAL
19-353
 100 mm

I N S T R U M E N T S



URINAL - FEMALE
19-354



URINAL - MALE
19-355

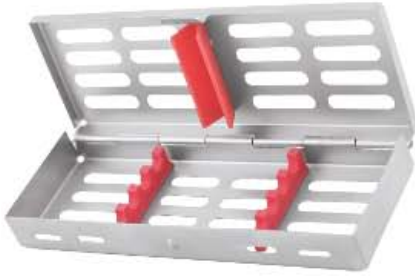

SHAVING MUG
19-356
 100 mm

INSTRUMENTS MANAGEMENT SYSTEM

**Cassette For 4 Instruments
19-357**

**Cassette For 5 Instruments
19-358**

**Cassette For 6 Instruments
19-359**

**Cassette For 7 Instruments
19-360**

**Cassette For 10 Instruments
19-361**

**Cassette For 20 Instruments
19-362**

**Cassette For Extraction Forceps
19-363**

**Cassette For Root Elevator
19-364**

**19-365
Cassette Tray
15 Pcs**

**19-366
Cassette Tray
15 Pcs**

**Instruments Cassette
19-367 5 Pieces Cassette
19-368 7 Pieces Cassette
19-369 10 Pieces Cassette**

**19-370
18×11×3.5cm
Extra large cassette for 6
Instruments, with compartment
for small parts hinged lids**

STERILIZING MESH TRAY

Different sizes & dimensions
are available at buyer's demand



MESH TRAYS
19-371
Different sizes & dimensions
are available at buyer's demand



MESH TRAYS
19-372
05 Pcs



MESH TRAYS
19-373
07 Pcs



MESH TRAYS
19-374
10 Pcs



MESH TRAYS
19-375
20 Pcs



19-376
Mesh Cassettes
5 Pieces, 7 Pieces, 10 Pieces,
15 Pieces & 20 Pieces

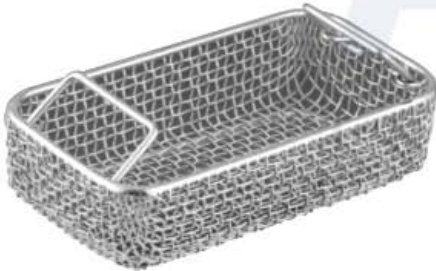

MESH TRAY
19-377 240x130x50mm
19-378 240x130x60mm
19-379 240x250x50mm
19-380 240x250x60mm
19-381 480x250x50mm
19-382 480x250x60mm
19-383 480x250x70mm

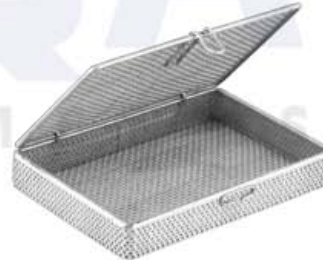

MESH TRAY
19-384 240x250x 50mm
19-385 240x250x 60mm
19-386 240x250x 70mm
19-387 480x250x 50mm
19-388 480x250x 60mm
19-389 480x250x 70mm
19-390 480x250x100mm



MESH TRAY
19-391 240x250x50mm
19-392 240x250x60mm
19-393 240x250x70mm
19-394 280x250x50mm
19-395 280x250x60mm

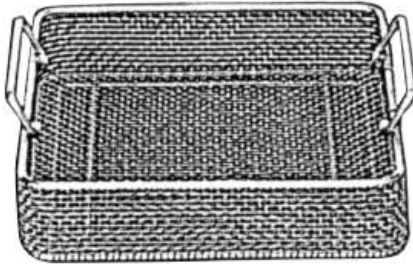

MESH TRAY
19-396 280x250x 70mm
19-397 280x250x100mm
19-398 280x250x 50mm
19-399 280x280x 60mm
19-400 280x280x 70mm
19-401 300x280x 60mm

MESH BASKET

- 19-402 240 x 258 x 50 mm
- 19-403 250 x 240 x 100 mm
- 19-404 240 x 250 x 60 mm

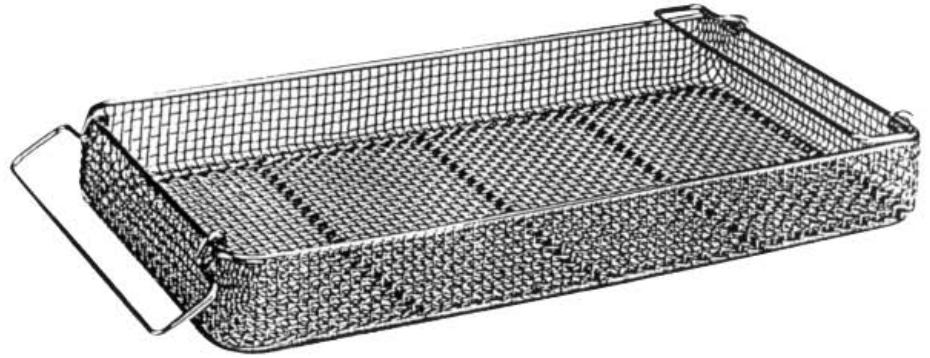

MESH BASKET

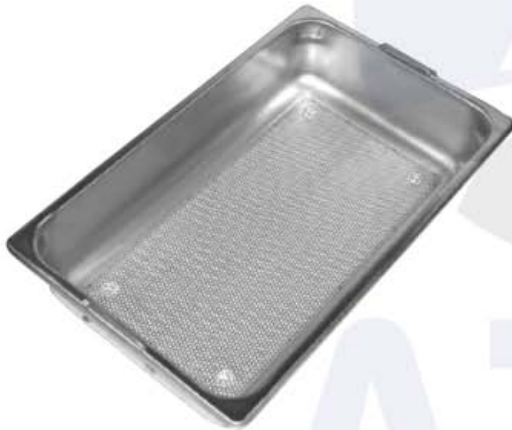
- 19-405 480 x 258 x 50 mm
- 19-406 480 x 258 x 100 mm
- 19-407 520 x 258 x 60 mm
- 19-408 520 x 258 x 70 mm
- 19-409 450 x 340 x 70 mm
- 19-410 320 x 230 x 70 mm

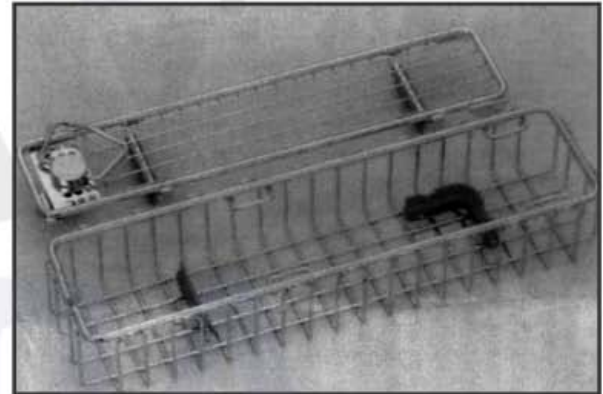

MESH BASKET

With Perforated Sheet Side

- 19-411 230 x 130 x 50 mm
- 19-412 230 x 130 x 60 mm
- 19-413 240 x 130 x 50 mm
- 19-414 240 x 130 x 60 mm
- 19-415 240 x 250 x 50 mm
- 19-416 240 x 250 x 60 mm
- 19-417 480 x 250 x 50 mm
- 19-418 480 x 250 x 60 mm
- 19-419 480 x 250 x 70 mm
- 19-420 300 x 300 x 50 mm
- 19-421 350 x 350 x 60 mm
- 19-422 470 x 400 x 60 mm
- 19-423 480 x 480 x 50 mm
- 19-424 480 x 480 x 60 mm
- 19-425 500 x 300 x 50 mm
- 19-426 520 x 300 x 50 mm
- 19-427 520 x 300 x 60 mm
- 19-428 550 x 430 x 50 mm
- 19-429 600 x 300 x 60 mm

ARTHROSCOPE BASKET

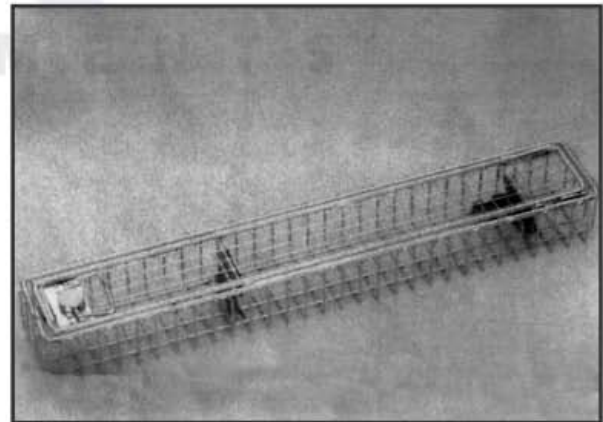
- 19-430 290 x 80 x 52 mm

ENDOSCOPE BASKET

- 19-431 460 x 80 x 52 mm
- 19-432 660 x 80 x 52 mm
- 19-433 670 x 80 x 52 mm

Sterilisieren Zange
Pinzas de esterilización

Pinces stérilisation
Pinze di sterilizzazione



DAVIS
19-434 16 cm, 6 1/4"
19-435 20 cm, 8"
19-436 24 cm, 9 1/2"



UTILITY
19-437 20 cm, 8"
19-438 28 cm, 11"



19-439 20 cm, 8"
19-440 25 cm, 10"
19-441 30 cm, 11 3/4"



ROGGE
19-442
27 cm, 11"



CHEATEL
Box Joint
19-443
27 cm, 11"



CHEATEL
Screw Joint
19-444
27 cm, 11"

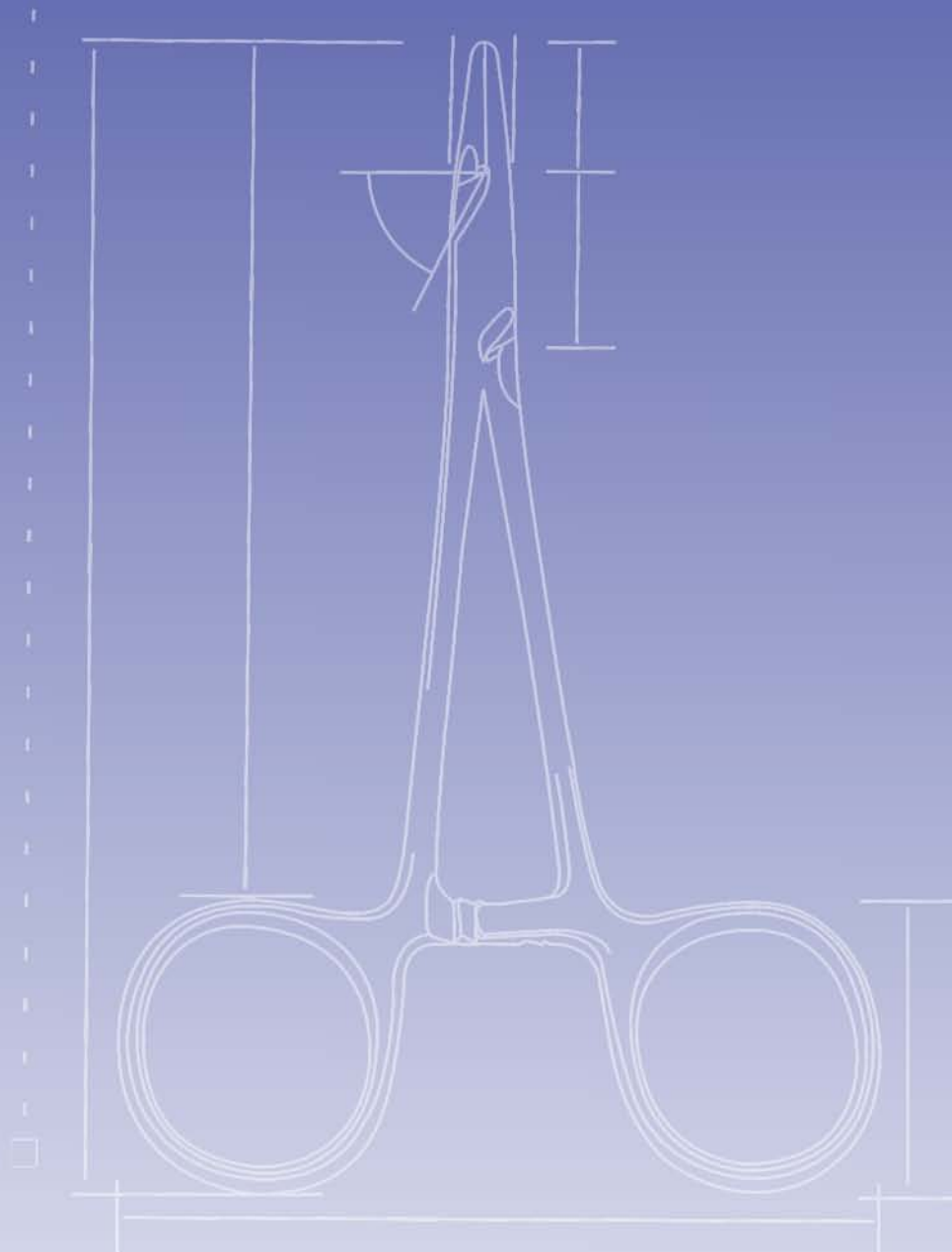

Manufacturers & Exporters of Quality Dental & Surgical instruments

Sadaye Shehar Road. SIE Sialkot 51310 Pakistan

City: Sialkot-Punjab

Postal Code : 51310 email: azqa.instruments@gmail.com

Info@azqainstruments.com

Contact number +92 332 9598000

Whatapp/ WeChat +923087708383

www.azqainstruments.com

Alibaba <https://azqa.trustpass.alibaba.com/>